

MODEL 71076-3

**1/16**  
**E REVO**  
**VXL**  
BRUSHLESS



**TRAXXAS**

OWNER'S MANUAL



# INTRODUCTION

- 3 BEFORE YOU PROCEED
- 4 SAFETY PRECAUTIONS
- 7 TOOLS, SUPPLIES, AND REQUIRED EQUIPMENT
- 8 ANATOMY OF THE 1/16 E-REVO VXL
- 9 QUICK START: GETTING UP TO SPEED
- 10 TRAXXAS TQi RADIO & VELINEON POWER SYSTEM
- 18 ADJUSTING THE ELECTRONIC SPEED CONTROL
- 20 DRIVING YOUR MODEL
- 23 TUNING ADJUSTMENTS
- 28 MAINTAINING YOUR MODEL
- 29 TQi ADVANCED TUNING GUIDE

Thank you for purchasing a Traxxas VXL 1/16 scale model. Your new model combines proven Traxxas innovations, including F1-inspired rocker-actuated suspension, waterproof electronics, and a monocoque-style chassis for outstanding handling and incredible speed and power. Your Traxxas model is designed for high-performance driving, with balanced weight distribution, lightweight and high-strength materials, and the precise engineering that is the hallmark of all Traxxas vehicles.

Your model's Velineon brushless motor system represents the state of the art in Ready-To-Race® electric power. In addition to the high power output and incredible speeds possible with brushless technology, the Velineon system offers precise throttle feel, built-in Low-Voltage Detection, and Traxxas' exclusive Training Mode. Only Traxxas makes brushless power so easy, fast, and fun.

We know you're excited about getting your new model on the road, but it's very important that you take some time to read through the Owner's Manual. This manual contains all the necessary setup and operating procedures that allow you to unlock the performance and potential that Traxxas engineers designed into your model. **Even if you are an experienced R/C enthusiast, it's important to read and follow the procedures in this manual.**

Thank you again for going with Traxxas. We work hard every day to assure you the highest level of customer satisfaction possible. We truly want you to enjoy your new model!

#### FCC Compliance

This device contains a module that complies with the limits for a Class B digital device as described in part 15 of the FCC rules. Operation is subject to the following two conditions: (1) This device may not cause harmful interference, and (2) this device must accept any interference received, including interference that may cause undesired operation.

The limits for a Class B digital device are designed to provide reasonable protection against harmful interference in residential settings. This product generates, uses and can radiate radio frequency energy, and, if not operated in accordance with the instructions, may cause harmful interference to radio communications. The user is cautioned that changes or modifications not expressly approved by the party responsible for compliance could void the user's authority to operate the equipment.

#### Canada, Industry Canada (IC)

This Class B digital apparatus complies with Canadian ICES-003 and RSS-210. This device complies with Industry Canada license exempt RSS standard(s). Operation is subject to the following two conditions: This device may not cause interference, and this device must accept any interference, including interference that may cause undesired operation of the device.

#### Radio Frequency (RF) Exposure Statement

This equipment complies with radio frequency exposure limits set forth by FCC and Industry Canada for an uncontrolled environment. This equipment should be installed and operated with a minimum distance of 20 centimeters between the radiator and your body or bystanders and must not be co-located or operating in conjunction with any other antenna or transmitter.

#### TQi Radio System

Operation Frequency: 2414~2453 MHz

Maximum Radio Frequency Power: Maximum Peak Power 9.7 dBm

#### Traxxas High-Current Connector

Operation Frequency: 13.56 MHz

Maximum Radio Frequency Power: Maximum Peak Power -29.27 dBuA/m @ 10m

#### Traxxas Support

Traxxas support is with you every step of the way. Refer to the next page to find out how to contact us and what your support options are.



#### Quick Start

This manual is designed with a Quick Start path that outlines the necessary procedures to get your model up and running in the shortest time possible. If you are an experienced R/C enthusiast, you will find it helpful and fast. Be sure and read through the rest of the manual to learn about important safety, maintenance, and adjustment procedures. Turn to page 9 to begin.



## BEFORE YOU PROCEED

Carefully read and follow all instructions in this and any accompanying materials to prevent serious damage to your model. Failure to follow these instructions will be considered abuse and/or neglect.

Before running your model, look over this entire manual and examine the model carefully. If for some reason you decide it is not what you wanted, then do not continue any further. **Your hobby dealer absolutely cannot accept a model for return or exchange after it has been run.**

### WARNINGS, HELPFUL HINTS, & CROSS-REFERENCES

Throughout this manual, you'll notice warnings and helpful hints identified by the icons below. Be sure to read them!



An important warning about personal safety or avoiding damage to your model and related components.



Special advice from Traxxas to make things easier and more fun.



Refers you to a page with a related topic.

### SUPPORT

If you have any questions about your model or its operation, call the Traxxas Technical Support Line toll-free at: **1-888-TRAXXAS (1-888-872-9927)\***

Technical support is available Monday through Friday from 8:30am to 9:00pm central time. Technical assistance is also available at [Traxxas.com/support](http://Traxxas.com/support). You may also e-mail customer support with your question at [support@Traxxas.com](mailto:support@Traxxas.com). Join thousands of registered members in our online community at [Traxxas.com](http://Traxxas.com).

Traxxas offers a full-service, on-site repair facility to handle any of your Traxxas service needs. Maintenance and replacement parts may be purchased directly from Traxxas by phone or online at [Traxxas.com](http://Traxxas.com). You can save time, along with shipping and handling costs, by purchasing replacement parts from your local dealer.

Do not hesitate to contact us with any of your product support needs. We want you to be thoroughly satisfied with your new model!

Traxxas  
6250 Traxxas Way  
McKinney, Texas 75070  
Phone: 972-549-3000  
Toll-free 1-888-TRAXXAS

Internet  
[Traxxas.com](http://Traxxas.com)  
E-mail: [support@Traxxas.com](mailto:support@Traxxas.com)

Entire contents ©2019 Traxxas. Traxxas, Ready-To-Race, Ready-To-Win, Velineon, 1/16 E-Revo VXL, and ProGraphix are trademarks or registered trademarks of Traxxas. Other brand names and marks are the property of their respective holders and are used only for purposes of identification. No part of this manual may be reproduced or distributed in print or electronic media without the express written permission of Traxxas. Specifications are subject to change without notice.

## SAFETY PRECAUTIONS



All instructions and precautions outlined in this manual should be strictly followed to ensure safe operation of your model.



This model is not intended for use by children under 14 years of age without the supervision of a responsible and knowledgeable adult.



Previous experience with radio controlled models is recommended. Models require a higher level of setup, maintenance, or support equipment.

All of us at Traxxas want you to safely enjoy your new model. Operate your model sensibly and with care, and it will be exciting, safe, and fun for you and those around you. Failure to operate your model in a safe and responsible manner may result in property damage and serious injury. The precautions outlined in this manual should be strictly followed to help ensure safe operation. You alone must see that the instructions are followed and the precautions are adhered to.

### Important Points to Remember

- Your model is not intended for use on public roads or congested areas where its operation can conflict with or disrupt pedestrian or vehicular traffic.
- Never, under any circumstances, operate the model in crowds of people. Your model is very fast and could cause injury if allowed to collide with anyone.
- Because your model is controlled by radio, it is subject to radio interference from many sources that are beyond your control. Since radio interference can cause momentary losses of radio control, always allow a safety margin in all directions around the model in order to prevent collisions.
- The motor, battery, and speed control can become hot during use. Be careful to avoid getting burned.
- Don't operate your model at night, or anytime your line of sight to the model may be obstructed or impaired in any way.
- **Most importantly, use good common sense at all times.**

### Speed Control

Your speed control is an extremely powerful electronic device capable of delivering high current. Please closely follow these precautions to prevent damage to the speed control or other components.

- **Disconnect the Battery:** Always disconnect the battery from the speed control when not in use.
- **Transmitter on First:** Switch on your transmitter first before switching on the speed control to prevent runaways and erratic performance.
- **Don't Get Burned:** The heat sink can get extremely hot, so be careful not to touch it until it is cool. Supply adequate airflow for cooling.

- **Use Stock Connectors:** If you decide to change the battery or motor connectors, only change one battery or motor connector at a time. This will prevent damage from accidentally mis-wiring the speed control. Please note that modified speed controls can be subject to a rewiring fee when returned for service. Removing the battery connector on the speed control or using connectors with no reverse-polarity protection on the speed control will void the product's warranty.
- **Insulate the Wires:** Always insulate exposed or damaged wiring with heat shrink tubing to prevent short circuits.
- **No Reverse Voltage:** The speed control is not protected against reverse polarity voltage. When changing the battery and/or motor, be sure to install the same type of connectors to avoid reverse polarity damage to the speed control. Removing the battery connectors on the speed control or using the same-gender connectors on the speed control will void the product's warranty.
- **No Schottky Diodes:** External Schottky diodes are not compatible with reversing speed controls. Using a Schottky diode will damage the electronic speed control and void the 30-day warranty.

### Recycling Your Traxxas Power Cell NiMH Battery

Traxxas strongly encourages you to recycle your Power Cell NiMH battery when it has reached the end of its useful life. **Do not throw your battery in the trash.** All Power Cell NiMH battery packs display the RBRC (Rechargeable Battery Recycling Corporation) icon, indicating they are recyclable. To find a recycling center near you, ask your local hobby dealer or visit [www.call2recycle.org](http://www.call2recycle.org).





## WARNING! CAUTION! DANGER!

**FIRE HAZARD!** Your model is able to use LiPo batteries. Charging and discharging batteries has the potential for fire, explosion, serious injury, and property damage if not performed per the instructions. Before use, read and follow all manufacturer's instructions, warnings, and precautions. In addition, Lithium Polymer (LiPo) batteries pose a SEVERE risk of fire if not properly handled per the instructions and require special care and handling procedures for long life and safe operation. LiPo batteries are intended only for advanced users that are educated on the risks associated with LiPo battery use. Traxxas does not recommend that anyone under the age of 14 use or handle LiPo battery packs without the supervision of a knowledgeable and responsible adult. Dispose of used batteries according to the instructions.

### Important Warnings for users of Lithium Polymer (LiPo) batteries:

- LiPo batteries have a minimum safe discharge voltage threshold that should not be exceeded. The electronic speed control is equipped with built-in Low-Voltage Detection that alerts the driver when LiPo batteries have reached their minimum voltage (discharge) threshold. It is the driver's responsibility to stop immediately to prevent the battery pack from being discharged below its safe minimum threshold.
- Low-Voltage Detection is just one part of a comprehensive plan for safe LiPo battery use. It is critical to follow all instructions for safe and proper charging, use, and storage of LiPo batteries. Make sure you understand how to use your LiPo batteries. If you have questions about LiPo battery usage, please consult with your local hobby dealer or contact the battery manufacturer. As a reminder, all batteries should be recycled at the end of their useful life.
- ONLY use a Lithium Polymer (LiPo) balance charger with a balance adapter port to charge LiPo batteries. Never use NiMH or NiCad-type chargers or charge modes to charge LiPo batteries. DO NOT charge with a NiMH-only charger. The use of a NiMH or NiCad charger or charge mode will damage the batteries and may cause fire and personal injury.
- NEVER charge LiPo battery packs in series or parallel. Charging packs in series or parallel may result in improper charger cell recognition and an improper charging rate that may lead to overcharging, cell imbalance, cell damage, and fire.



- ALWAYS inspect your LiPo batteries carefully before charging. Look for any loose leads or connectors, damaged wire insulation, damaged cell packaging, impact damage, fluid leaks, swelling (a sign of internal damage), cell deformity, missing labels, or any other damage or irregularity. If any of these conditions are observed, do not charge or use the battery pack. Follow the disposal instructions included with your battery to properly and safely dispose of the battery.
- DO NOT store or charge LiPo batteries with or around other batteries or battery packs of any type, including other LiPos.
- Store and transport your battery pack(s) in a cool dry place. DO NOT store in direct sunlight. DO NOT allow the storage temperature to exceed 140°F or 60°C, such as in the trunk of a car, or the cells may be damaged and create a fire risk.
- DO NOT disassemble LiPo batteries or cells.
- DO NOT attempt to build your own LiPo battery pack from loose cells.

### Charging and handling precautions for all battery types:

- Use the supplied NiMH charger to charge the included battery. DO NOT attempt to charge LiPo batteries or any other type of battery with this charger.
- BEFORE you charge, ALWAYS confirm that the charger settings exactly match the type (chemistry), specification, and configuration of the battery to be charged.
- DO NOT attempt to charge non-rechargeable batteries (explosion hazard), batteries that have an internal charge circuit or a protection circuit, batteries that have been altered from original manufacturer configuration, or batteries that have missing or unreadable labels, preventing you from properly identifying the battery type and specifications.
- DO NOT exceed the maximum manufacturer recommended charge rate.
- DO NOT let any exposed battery contacts or wires touch each other. This will cause the battery to short circuit and create the risk of fire.
- While charging or discharging, ALWAYS place the battery (all types of batteries) in a fire retardant/fire proof container and on a non-flammable surface such as concrete.

(continued from previous page)

- DO NOT charge batteries inside of an automobile. DO NOT charge batteries while driving in an automobile. This charger is equipped with a long cord intended to allow the battery to be charged outside of an automobile when using the automobile's auxiliary power socket. If the cord will not reach outside of the automobile, find another power source.
- NEVER charge batteries on wood, cloth, carpet, or on any other flammable material.
- ALWAYS charge batteries in a well-ventilated area.
- REMOVE flammable items and combustible materials from the charging area.
- DO NOT leave the charger and battery unattended while charging, discharging, or anytime the charger is ON with a battery connected. If there are any signs of a malfunction or in the event of an emergency, unplug the charger from the power source and disconnect the battery from the charger.
- DO NOT operate the charger in a cluttered space, or place objects on top of the charger or battery.
- If any battery or battery cell is damaged in any way, DO NOT charge, discharge, or use the battery.
- Keep a Class D fire extinguisher nearby in case of fire.
- DO NOT disassemble, crush, short circuit, or expose the batteries to flame or other source of ignition. Toxic materials could be released. If eye or skin contact occurs, flush with water.
- If a battery gets hot to the touch during the charging process (temperature greater than 110°F / 43°C), immediately disconnect the battery from the charger and discontinue charging.
- Allow the battery pack to cool off between runs (before charging).
- ALWAYS unplug the charger and disconnect the battery when not in use.
- ALWAYS unplug the battery from the electronic speed control when the model is not in use and when it is being stored or transported.
- DO NOT disassemble the charger.
- REMOVE the battery from your model or device before charging.
- DO NOT expose the charger to water or moisture.
- ALWAYS store battery packs safely out of the reach of children or pets. Children should always have adult supervision when charging and handling batteries.
- Nickel-Metal Hydride (NiMH) batteries must be recycled or disposed of properly.
- Always proceed with caution and use good common sense at all times.

## TOOLS, SUPPLIES, AND REQUIRED EQUIPMENT

Your model comes with a set of specialty metric tools. You'll need to purchase other items, available from your hobby dealer, to operate and maintain your model.

### Supplied Tools and Equipment



1.5mm "L" wrench

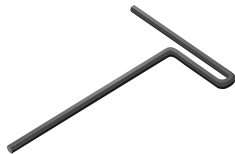

2.0mm "T" wrench



2.5mm "L" wrench



4-way wrench



NiMH battery charger\*



6-cell 2/3A NiMH battery\*



Body clips

### Required Equipment



4 AA alkaline batteries

\*Battery and charger style are subject to change and may vary from images.

### APPLYING THE DECALS

The main decals for your model have been applied at the factory. Additional decals are printed on self-adhesive clear mylar and are die-cut for easy removal. Use a hobby knife to lift the corner of a decal and lift it from the backing. To apply the decals, place one end down, hold the other end up, and gradually smooth the decal down with your finger as you go. This will prevent air bubbles. Placing both ends of the decal down and then trying to smooth it out will result in air pockets.

Look at the photos on the box for typical decal placement.

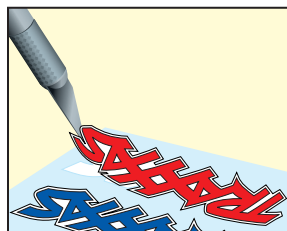

For more information on batteries, see *Use the Right Batteries* on page 13.



### Recommended Equipment

These items are not required for the operation of your model, but are a good idea to include in any R/C toolbox:

- Safety glasses
- Traxxas Ultra Premium Tire Glue, Part #6468 (CA glue)
- Hobby knife
- Side cutters and/or needle nose pliers
- Phillips screwdriver
- Soldering iron



# ANATOMY OF THE 1/16 E-REVO VXL

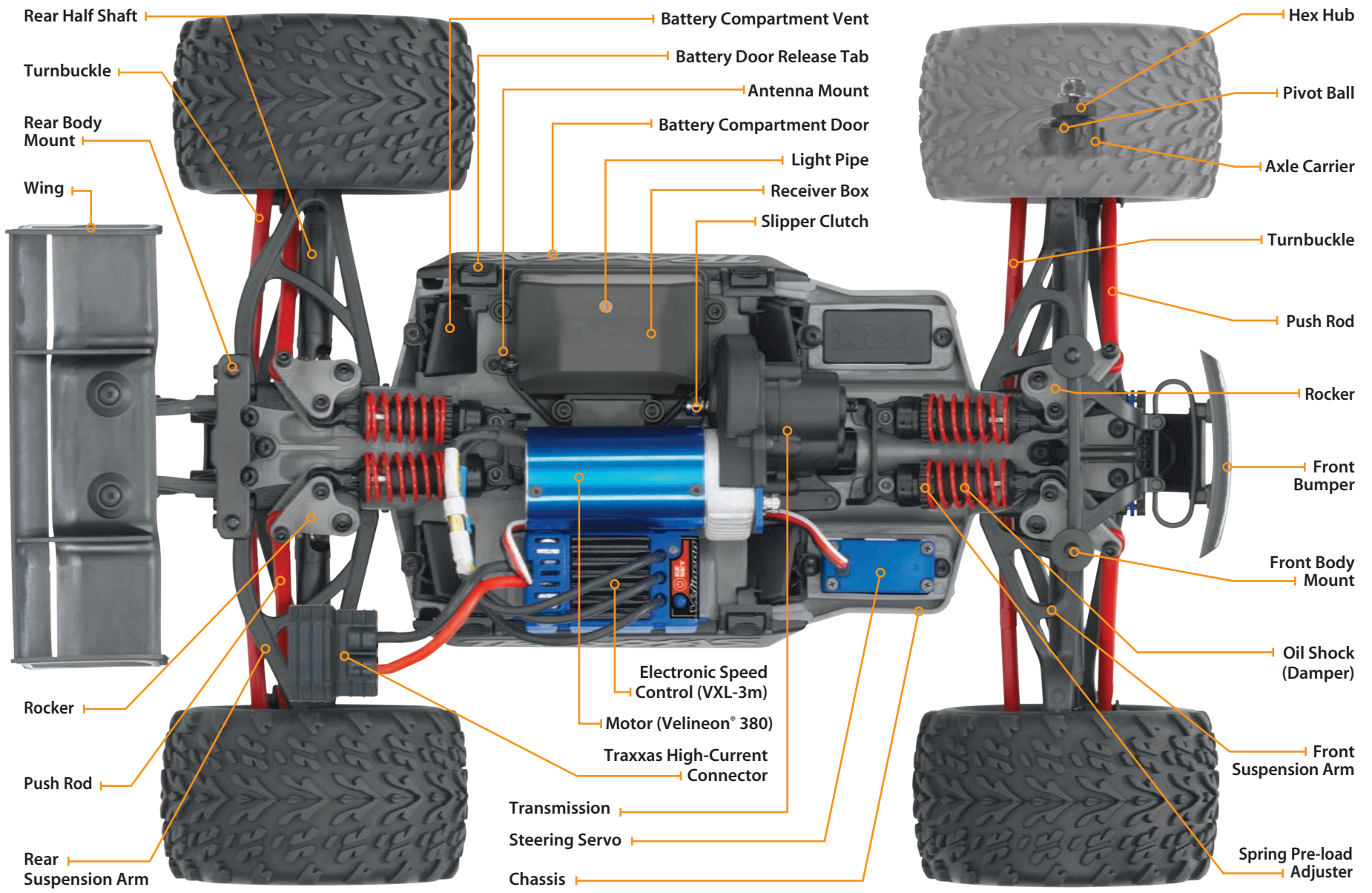

Rear Half Shaft  
 Turnbuckle  
 Rear Body Mount  
 Wing  
 Rocker  
 Push Rod  
 Rear Suspension Arm

Battery Compartment Vent  
 Battery Door Release Tab  
 Antenna Mount  
 Battery Compartment Door  
 Light Pipe  
 Receiver Box  
 Slipper Clutch

Electronic Speed Control (VXL-3m)  
 Motor (Velineon® 380)  
 Traxxas High-Current Connector

Transmission  
 Steering Servo  
 Chassis

Hex Hub  
 Pivot Ball  
 Axle Carrier  
 Turnbuckle  
 Push Rod  
 Rocker  
 Front Bumper  
 Front Body Mount  
 Oil Shock (Damper)  
 Front Suspension Arm  
 Spring Pre-load Adjuster



 The following guide is an overview of the procedures for getting your model running. Look for the Quick Start logo on the bottom corners of Quick Start pages.

**1. Read the safety precautions on pages 4-6**

For your own safety, understand where carelessness and misuse could lead to personal injury.

**8. Range test the radio system • See page 16**

Follow this procedure to make sure your radio system works properly at a distance and that there is no interference from outside sources.

**2. Charge the battery pack • See page 13**

Fully charge the battery pack included with your model.

**9. Detail your model • See page 7**

Apply other decals if desired.

**3. Install the antenna • See page 14**

The receiver antenna and antenna tube must be properly installed before operating your model.

**10. Drive your model • See page 20**

Driving tips and adjustments for your model.

**4. Install batteries in the transmitter • See page 13**

The transmitter requires 4 AA alkaline batteries (sold separately).

**11. Maintaining your model • See page 28**

Follow these critical steps to maintain the performance of your model and keep it in excellent running condition.

**5. Install the battery pack • See page 14**

Install the included battery pack in your model.

**6. Turn on the radio system • See page 15**

Make a habit of turning the transmitter on first and off last.

**7. Check servo operation • See page 16**

Make sure the steering servo is working correctly.



The Quick Start Guide is not intended to replace the full operating instructions available in this manual. Please read this entire manual for complete instructions on the proper use and maintenance of your model.

Look for the Quick Start logo at the bottom of Quick Start pages.



## INTRODUCTION

Your model includes the latest Traxxas TQi 2.4GHz transmitter with Traxxas Link™ Model Memory. The transmitter's easy-to-use design provides instant driving fun for new R/C enthusiasts, and also offers a full complement of pro-level tuning features for advanced users – or anyone interested in experimenting with the performance of their model. The steering and throttle channels feature adjustable Exponential, End Points, and Sub-Trims. Steering and braking Dual Rate are also available. Many of the next-level features are controlled by the Multi-Function knob, which can be programmed to control a variety of functions. The detailed instructions (page 29) and Menu Tree (page 32) included in this manual will help you understand and operate the advanced functions of the new TQi radio system. For additional information and how-to videos, visit [Traxxas.com](http://Traxxas.com).

## RADIO AND POWER SYSTEM TERMINOLOGY

Please take a moment to familiarize yourself with these radio and power system terms. They will be used throughout this manual. A detailed explanation of the advanced terminology and features of your new radio system begins on page 29.

**2.4GHz Spread Spectrum** – This model is equipped with the latest R/C technology. Unlike AM and FM systems that require frequency crystals and are prone to frequency conflicts, the TQi system automatically selects and locks onto an open frequency, and offers superior resistance to interference and “glitching.”

**BEC (Battery Eliminator Circuit)** - The BEC can either be in the receiver or in the ESC. This circuit allows the receiver and servos to be powered by the main battery pack in an electric model. This eliminates the need to carry a separate pack of 4 AA batteries to power the radio equipment.

**Brushless Motor** - A DC brushless motor replaces the brushed motor's traditional commutator and brush arrangement with intelligent electronics that energize the electromagnetic windings in sequence to provide rotation. Opposite of a brushed motor, the brushless motor has its windings (coils) on the perimeter of the motor can and the magnets are mounted to the spinning rotor shaft.

**Cogging** - Cogging is a condition sometimes associated with brushless motors. Typically, it is a slight stutter noticed when accelerating from a stop. It happens for a very short period as the signals from the electronic speed control and the motor

synch with each other. The VXL-3m is optimized to virtually eliminate cogging.

**Current** - Current is a measure of power flow through the electronics, usually measured in amps. If you look at wire like a garden hose, current is a measure of how much water is flowing through the hose.

**ESC (Electronic Speed Control)** - An electronic speed control is the electronic motor control inside the model. Electronic speed controls use power more efficiently than mechanical speed controls so that the battery runs longer. An electronic speed control also has circuitry that prevents loss of steering and throttle control as the battery loses its charge.

**Frequency band** - The radio frequency used by the transmitter to send signals to your model. This model operates on the 2.4GHz direct-sequence spread spectrum.

**kV Rating** - Brushless motors are often rated by their kV number. The kV rating equals no-load motor rpm with 1 volt applied. The kV increases as the number of wire turns in the motor decreases. As the kV increases, the current draw through the electronics also increases.

**LiPo** - Abbreviation for Lithium Polymer. Rechargeable LiPo battery packs are known for their special chemistry, which allows extremely high energy density and current handling in a compact size. These are high-performance batteries that require special care and handling. For advanced users only.

**mAh** – Abbreviation for milliamp hour, a measure of the capacity of the battery pack. The higher the number, the longer the battery will last between recharges.

**Neutral position** - The standing position that the servos seek when the transmitter controls are at the neutral setting.

**NiCad** - Abbreviation for nickel-cadmium. The original rechargeable hobby pack, NiCad batteries have very high current handling, high capacity, and can last up to 1000 charging cycles. Good charging procedures are required to reduce the possibility of developing a “memory” effect and shortened run times.

**NiMH** - Abbreviation for nickel-metal hydride. Rechargeable NiMH batteries offer high current handling and much greater resistance to the “memory” effect. NiMH batteries generally allow higher capacity than NiCad batteries. They can last up to 500 charge cycles. A peak charger designed for NiMH batteries is required for optimal performance.

**Receiver** - The radio unit inside your model that receives signals from the transmitter and relays them to the servos.

**Resistance** - In an electrical sense, resistance is a measure of how an object resists or obstructs the flow of current through it. When flow is constricted, energy is converted to heat and is lost. Traxxas power systems are optimized to reduce electrical resistance and the resulting power-robbing heat.

**Rotor** - The rotor is the main shaft of the brushless motor. In a brushless motor, the magnets are mounted to the rotor, and the electromagnetic windings are built into the motor housing.

**Sensored** - Sensored refers to a type of brushless motor that uses an internal sensor in the motor to communicate rotor position information back to the electronic speed control.

**Sensorless** - Sensorless refers to a brushless motor that uses advanced instructions from an electronic speed control to provide smooth operation. Additional motor sensors and wiring are not required.

**Servo** - Small motor unit in your model that operates the steering mechanism.

**Transmitter** - The hand-held radio unit that sends throttle and steering instructions to your model.

**Trim** - The fine-tuning adjustment of the neutral position of the servos, made by adjusting the steering trim knob on the face of the transmitter.

**Thermal Shutdown Protection** - Temperature sensing electronics used in the electronic speed control detect overloading and overheating of the transistor circuitry. If excessive temperature is detected, the unit automatically shuts down to prevent damage to the electronics.

**2-channel radio system** - The TQi radio system, consisting of the receiver, the transmitter, and the servos. The system uses two channels: one to operate the throttle and one to operate the steering.

**Voltage** - Voltage is a measure of the electrical potential difference between two points, such as between the positive battery terminal and ground. Using the analogy of the garden hose, while current is the quantity of water flow in the hose, voltage corresponds to the pressure that is forcing the water through the hose.

### IMPORTANT RADIO SYSTEM PRECAUTIONS

- Do not kink the receiver’s antenna wire. Kinks in the antenna wire will reduce range.
- DO NOT CUT any part of the receiver’s antenna wire. Cutting the antenna will reduce range.
- You must extend the antenna wire in the model as far as possible for maximum range. In doing so, the antenna wire will be extended outside of the vehicle body. Do not wrap or coil the antenna wire to keep it from extending out of the body.
- The antenna wire must be installed into the antenna tube to protect it from getting cut or damaged, which will reduce range. When installing the antenna wire into the antenna tube, be careful not to kink the wire by pressing it against the antenna tube cap. The antenna wire should extend to just below or to within one-half inch below the cap.



To prevent loss of radio range, do not kink or cut the black wire, do not bend or cut the metal tip, and do not bend or cut the white wire at the end of the metal tip.

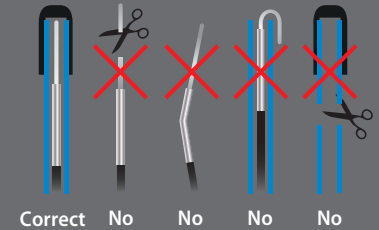

Correct No No No No

VXL-3m Wiring Diagram

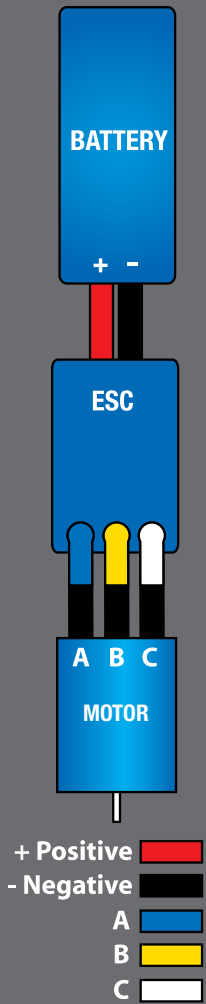

Your model is equipped with the newest TQi 2.4GHz transmitter with Traxxas Link™ Model Memory. The transmitter has two channels for controlling your throttle and steering. The receiver inside the model has 5 output channels. Your model is equipped with one servo and an electronic speed control.

TRANSMITTER AND RECEIVER



\*\* Accessory sensor port for use with the Telemetry Expander Module (see Traxxas.com for more information)

MODEL WIRING DIAGRAM

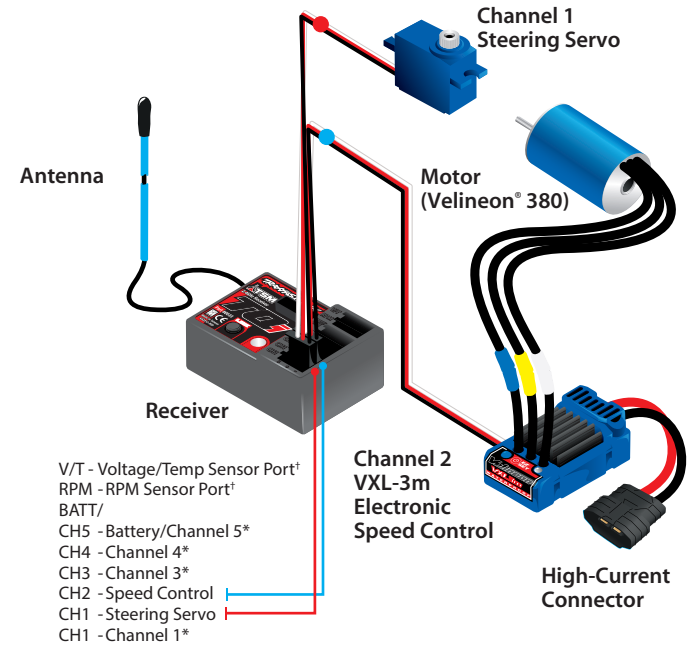

\*Not used †Accessory sensor ports for use with standard voltage/temperature and RPM telemetry sensors (see Traxxas.com and included materials for more information)

VXL-3M ELECTRONIC SPEED CONTROL

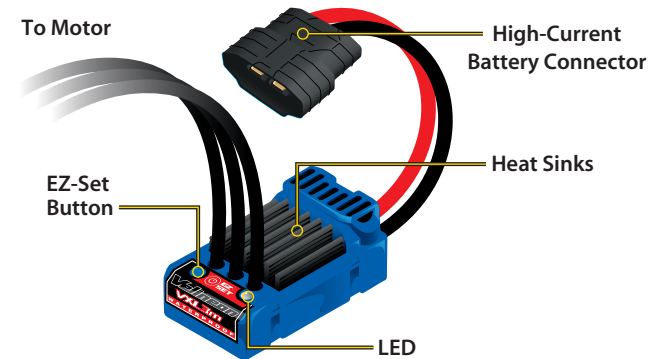

### INSTALLING TRANSMITTER BATTERIES

Your TQi transmitter uses 4 AA batteries. The battery compartment is located in the base of the transmitter.

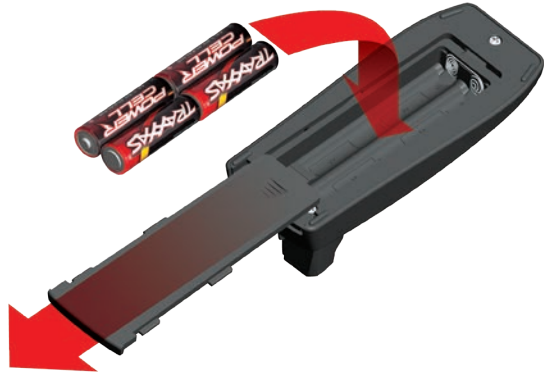

1. Remove the battery compartment door by pressing the tab and sliding the door open.
2. Install the batteries in the correct orientation as indicated in the battery compartment.
3. Reinstall the battery compartment door and snap it closed.
4. Turn on the transmitter and check the status LED for a solid green light.

If the status LED flashes red, the transmitter batteries may be weak, discharged, or possibly installed incorrectly. Replace with new or freshly charged batteries. The status LED does not indicate the charge level of the battery pack installed in the model. Refer to the Troubleshooting section on page 30 for more information on the transmitter status LED codes.



### CHARGING THE BATTERY PACK

The Traxxas Battery Charger is a fully featured NiMH (Nickel Metal Hydride) charger. It features 2-amp charge current for fast charging and advanced peak detection to optimize every charge. Take this compact charger with you wherever you want to have radio controlled fun! **Do not charge batteries inside of an automobile. Read the Safety Precautions section of this manual.**

1. Plug the charger into a 12-volt automotive auxiliary power socket. The charger is compatible with 12-volt automotive auxiliary power sockets only. The LED on the charger will glow red to indicate it is ready to charge a battery.

2. Connect the battery to begin charging. Plug the battery into the charger. The charger's LED will flash green, indicating that charging has begun. The flashing green LED on the charger indicates the charge progress.

3. Disconnect the battery when charging is complete. The Traxxas 2-amp DC charger uses sophisticated voltage-detection circuitry to monitor the battery and automatically stop charging when the pack has reached maximum capacity. When the battery is fully charged, the LED will light solid green. The battery will be warm in your hand. Disconnect the battery.



#### CHARGE PROGRESS

x1	1 green flash	0 - 25% charged
x2	2 green flashes	25% - 50% charged
x3	3 green flashes	50% - 75% charged
x4	4 green flashes	75% or more charged
	Solid green LED	100% charged

CHARGER LED INDICATION	MEANING
Solid Red LED	Ready for Charging
Slowly Flashing Green LED	Charging (see Charge Progress chart)
Solid Green LED	Battery Fully Charged
Flashing Red LED	Charger error

**The included charger is designed for use only with Traxxas NiMH batteries with iD. Legacy Traxxas High-Current Connectors are not compatible with this charger. DO NOT try to force legacy connectors into the charge connector.**

**If the status LED doesn't light green on the transmitter, check the polarity of the batteries. If you see any other flashing signal from the LED, refer to the chart on page 30 to identify the code.**

**Use the Right Batteries**  
Your transmitter uses AA batteries. Use new alkaline batteries. Do not use rechargeable AA cells to power the TQi transmitter, as they will not provide sufficient voltage for optimum transmitter performance.

Caution: Discontinue running your model at the first sign of weak batteries (flashing red light) to avoid losing control.



To prevent loss of radio range, do not kink or cut the black wire, do not bend or cut the metal tip, and do not bend or cut the white wire at the end of the metal tip.

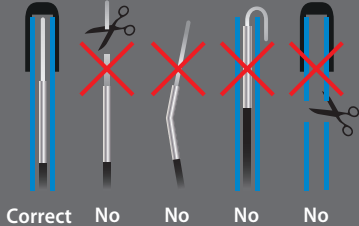

### Battery iD

Your model's included battery pack is equipped with Traxxas Battery iD. This exclusive feature allows Traxxas battery chargers (sold separately) to automatically recognize connected battery packs and optimize the charge settings for the battery. This eliminates the need to worry over charger settings and menus for the easiest and safest charging solution possible. Visit [Traxxas.com](http://Traxxas.com) to learn more about this feature and available Traxxas iD chargers and batteries.



## INSTALLING THE RECEIVER ANTENNA

The receiver antenna and antenna tube must be properly installed before operating your model. Follow these steps to install the antenna and antenna tube:

1. Slide the antenna wire into the antenna tube to its full extent. When fully inserted, the wire should reach to approximately 1/2 inch below the tube cap. Do not leave any slack in the antenna wire.
2. Remove the set screw from the opening next to the antenna mount with the supplied 1.5mm "L" wrench.
3. Insert the tube into the antenna mount. Take care not to crimp the antenna wire.
4. Reinstall and tighten the set screw with the supplied 1.5mm "L" wrench until it is flush with the top of the opening. **To prevent loss of radio range, do not kink or cut the black wire, do not bend or cut the metal tip, and do not bend or cut the white wire at the end of the metal tip. Do not shorten the antenna tube. See the sidebar for more information.**

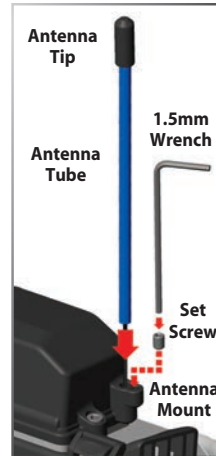

## INSTALLING THE BATTERY PACK

Your model includes a 7.2-volt battery pack. To properly balance the model, it should be installed in the battery compartment on the left side of the model. Follow these steps to install the battery:

### Battery Installation

1. Open the battery compartment door by pressing on the release tabs.
2. Install the battery pack with the battery wires facing the rear of the model.
3. Route the battery wire through the slot near the vent.
4. Close the battery door, making sure not to pinch the battery wires. Be sure both release tabs are fully engaged with the door. Do not connect the battery pack to the ESC at this time. **Note:** always unplug the battery and remove from the model after use.

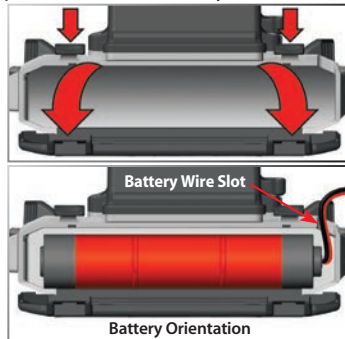

## The Traxxas High-Current Connector

Your model is equipped with the Traxxas High-Current Connector. Standard connectors restrict current flow and are not capable of delivering the power needed to maximize the output of the VXL-3m. The Traxxas connector's gold-plated terminals with large contact surfaces ensure positive current flow with the least amount of resistance. Secure, long-lasting, and easy to grip, the Traxxas connector is engineered to extract all the power your battery has to give.



### Using LiPo Packs in Your Model

The VXL-3m is compatible with 2S and 3S LiPo packs, and is equipped with Low-Voltage Detection circuitry to prevent over-discharging. Make certain LiPo mode is selected (*see page 19 for details*) when using LiPo packs in your model.

### Using an Additional Power Cell Series 1 NiMH Battery For Increased Speed

An additional Power Cell Series 1 NiMH battery may also be used to increase the top speed of your model to 50+mph by connecting the batteries in series using a Traxxas series connector (part #3063, sold separately). *This also requires a gearing change as described on page 26.*

**Note:** LiPo battery packs should NOT be used with a Traxxas series connector.

### 50+mph Battery and Gearing Installation Instructions

1. Install the included high-speed pinion gear as described in *Pinion Gear Installation Instructions* on page 26. Install the supplied battery as described on this page.
2. Install an identical Power Cell Series 1 NiMH battery in the opposite battery compartment.
3. Plug both batteries into the Y-harness (sold separately). The harness connects the two packs in series. The two 7.2-volt 6-cell battery packs will operate as one 14.4-volt 12-cell battery pack.
4. Plug the Y-harness into the speed control.

### Precautions

- **The High Speed dual-battery configuration is for high-speed running on smooth surfaces only. Avoid repetitive hard acceleration to prevent overstressing the motor, speed control, and batteries.**
- **Make certain both batteries are fully charged before installing them in your model. Installing a fully charged pack and a partially discharged pack may lead to overdischarging and damage to the partially discharged battery.**
- **Do not mix batteries of different brands, chemistries, or capacities. Only genuine Traxxas batteries are approved for dual-battery use in this model.**
- **Stop running your model and allow it to cool if the speed control's thermal overload protection activates or if the motor temperature exceeds 200°F.**



### Using an Additional Battery for Increased Run Time

Your model only requires one battery pack, but the chassis can accept two batteries. Your model can be run with two battery packs to extend run time. The batteries must be connected in parallel, which will combine the capacity of the two batteries (for example, two 7.2-volt 1000mAh packs connected in parallel will deliver a total capacity of 2000mAh, but total voltage will remain 7.2 volts). This is easily done with a parallel Y-harness (part #3064, sold separately). Be sure to only use the Y-harness with identical battery packs; do not mix batteries of different chemistries or capacities.



When operating your model with two batteries, be careful to monitor the temperature of the speed control and motor to prevent overheating. Stop running your model and allow it to cool if the speed control's thermal overload protection activates or if the motor temperature exceeds 200°F.



For best off-road handling with two battery packs, consider installing stiffer springs on your model. Traxxas offers accessory springs for this purpose; see the parts list included with your model for part numbers.

### RADIO SYSTEM RULES

- Always turn your transmitter on first and off last. This procedure will help to prevent your model from receiving stray signals from another transmitter, or other source, and running out of control. Your model has electronic failsafes to prevent this type of malfunction, but the first, best defense against a runaway model is to always turn the transmitter on first and off last.
- Always use new batteries for the radio system. Weak batteries will limit the radio signal between the receiver and the transmitter. Loss of the radio signal can cause you to lose control of your model.



- In order for the transmitter and receiver to bind to one another, the receiver in the model must be turned on within 20 seconds of turning on the transmitter. The transmitter LED will flash fast red, indicating a failure to link. If you miss it, simply turn off the transmitter and start over.
- Always turn on the transmitter before plugging in the battery.

### RADIO SYSTEM CONTROLS



### RADIO SYSTEM BASIC ADJUSTMENTS

#### Throttle Neutral Adjustment

The throttle neutral adjustment is located on the transmitter face and controls the forward/reverse travel of the throttle trigger. Change the adjustment by pressing the button and sliding it to the desired position. There are two settings available:



- 50/50: Allows equal travel for both acceleration and reverse.
- 70/30: Allows more throttle travel (70%) and less reverse travel (30%).

**Note:** We strongly recommend to leave this control in its factory location until you become familiar with all the adjustments and capabilities of your model. To change the throttle neutral adjust position, turn the transmitter off before adjusting the neutral position. You will need to reprogram your electronic speed control to recognize the 70/30 setting. Turn to ESC Setup Programming on page 18 for instructions.



Make certain the model's receiver antenna is properly installed before operating your model. See "Installing the Receiver Antenna." Failure to properly install the receiver antenna will result in greatly reduced radio range and potential loss of control.



Remember, always turn the transmitter on first and off last to avoid damage to your model.



Stop immediately at the first sign of weak batteries. Never turn the transmitter off when the battery pack is plugged in. The model could run out of control.





**Using Reverse:** While driving, push the throttle trigger forward to apply brakes. Once stopped, return the throttle trigger to neutral. Push the throttle trigger forward again to engage proportional reverse.

### Steering Trim

The electronic steering trim located on the face of the transmitter adjusts the neutral (center) point of the steering channel.



**Note:** Traxxas Stability Management (TSM) must be completely turned off while adjusting steering trim. See page 17 for TSM adjustments.

### Multi-Function Knob

The Multi-Function knob can be programmed to control a variety of functions. From the factory, the Multi-Function knob controls Traxxas Stability Management (TSM). For more detail on TSM, refer to page 17.



## USING THE RADIO SYSTEM

The TQi Radio System has been adjusted at the factory for correct operation with your model. The adjustment should be checked before running the model, in case of movement during shipping. Here's how:

1. Turn the transmitter switch on. The status LED on the transmitter should be solid green (not flashing).
2. **Elevate the model on a block or a stand so that all the tires are off the ground.** Make sure your hands are clear of the moving parts of the model.
3. Plug the battery pack in the model into the speed control.
4. The on/off switch is integrated into the speed control. With the transmitter on, press and release the EZ-Set button (.25 seconds). The LED will shine RED (see note, below). This turns the model on. To turn the VXL-3m off, press and hold the EZ-Set button until the LED turns off (.5 seconds). **Note:** If the LED shines green, Low-Voltage Detection is activated. This may cause poor performance from the included NiMH battery pack. The default factory setting is for Low-Voltage Detection to be disabled (LED shines red). Make sure to turn the Low-Voltage Detection on when using LiPo batteries. **Never use LiPo batteries while Low-Voltage Detection is turned off.** See page 19 for more information.
5. Turn the steering wheel on the transmitter back and forth and check for rapid operation of the steering servo. Also, check that the steering mechanism is not loose or binding. If the steering operates slowly, check for weak batteries.
6. When looking down at the model, the front wheels should be pointing straight ahead. If the wheels are turned slightly to the left

or right, turn off TSM (see page 17) and slowly adjust the steering trim control on the transmitter until they are pointing straight ahead; then, return the Multi-Function knob to the desired TSM setting.

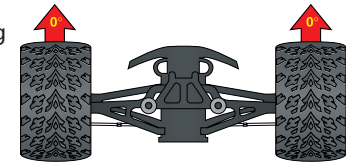

7. Gently operate the throttle trigger to ensure that you have forward and reverse operation, and that the motor stops when the throttle trigger is at neutral. **Warning: Do not apply full throttle in forward or reverse while the model is elevated.**
8. Once adjustments are made, turn off the receiver on your model, followed by the hand-held transmitter.

### Range-Testing the Radio System

Before each running session with your model, you should range-test your radio system to ensure that it operates properly.

1. Turn on the radio system and check its operation, as described in the previous section.
2. Have a friend hold the model. Make sure hands and clothing are clear of the wheels and other moving parts on the model.
3. Walk away from the model with the transmitter until you reach the farthest distance you plan to operate the model.
4. Operate the controls on the transmitter once again to be sure that the model responds correctly.
5. Do not attempt to operate the model if there is any problem with the radio system or any external interference with your radio signal at your location.

### Higher Speeds Require Greater Distance

The faster you drive your model, the more quickly it will near the limit of radio range. At top speeds, models can cover anywhere between 50 to 100 feet every second! It's a thrill, but use caution to keep your model in range. If you want to see your model achieve its maximum speed, it is best to position yourself in the middle of the truck's running area, not the far end, so you drive the truck towards and past your position. In addition to maximizing the radio's range, this technique will keep your model closer to you, making it easier to see and control.

**No matter how fast or far you drive your model, always leave adequate space between you, the model, and others. Never drive directly toward yourself or others.**



### TQi Binding Instructions

For proper operation, the transmitter and receiver must be electronically "bound." **This has been done for you at the factory.** Should you ever need to re-bind the system or bind to an additional transmitter or receiver, follow these instructions. **Note:** The receiver must be connected to a 4.8-6.0v (nominal) power source for binding and the transmitter and receiver must be within 5 feet of each other.

1. Press and hold the transmitter's SET button as you switch transmitter on. The transmitter's LED will flash red slowly. Release the SET button.
2. Press and hold the receiver's LINK button as you switch on the speed control by pressing the EZ-Set button. Release the LINK button.
3. When the transmitter and receiver's LEDs turn solid green, the system is bound and ready for use. Confirm that the steering and throttle operate properly before driving your model.

### TRAXXAS STABILITY MANAGEMENT (TSM)



Traxxas Stability Management or TSM allows you to experience all the speed and acceleration that was engineered into your Traxxas model by helping you to maintain control of the vehicle in low-traction situations. TSM helps provide straight ahead full-throttle acceleration on slippery surfaces, without fishtailing, spinouts, or loss of control. TSM also dramatically improves braking control. High speed cornering and control is also made possible as TSM makes corrections for you, without intruding on your fun, or creating unexpected side effects.

The Multi-Function knob on the TQi transmitter has been programmed to control TSM. The recommended (default) setting for TSM is to rotate the knob to the 12:00 position (the zero mark on the dial).

Turn the knob clockwise to increase assistance; turn the knob counterclockwise to decrease assistance. Turn the knob counterclockwise to its stop to turn TSM completely off. **Note:** TSM is deactivated automatically when driving or braking in reverse.

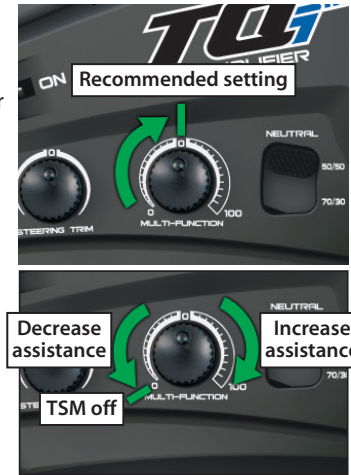

When driving on surfaces with some traction, decrease the TSM setting to allow the vehicle to feel more "loose" for power sliding, drifting, and so on. On surfaces with very little traction (loose dirt, smooth concrete, ice/snow), increase TSM to maximize acceleration and control.

Drive with TSM on and off to test how it is making your control of the vehicle easier and more precise. For more information, visit [Traxxas.com/tsm](http://Traxxas.com/tsm).

**Note:** TSM must be completely turned off while adjusting steering trim.



### Fail-Safe

Your Traxxas radio system is equipped with a built-in fail-safe function that returns the throttle to its last saved neutral position in the event of a signal loss. The LED on the transmitter and the receiver will rapidly flash red when the fail-safe mode is activated. If fail-safe activates while you are operating your model, determine the reason for signal loss and resolve the problem before operating your model again.



## VXL-3m LED codes

- **Solid Green:** VXL-3m power on light. Low-Voltage Detection is ON (LiPo setting).
- **Solid Red:** VXL-3m power on light. Low-Voltage Detection is OFF (NiCad/NiMH setting).
- ✶ **Fast Blinking Red:** Thermal Shutdown Protection Stage 1. If the motor has lower than normal power and the VXL-3m is hot, the VXL-3m has entered Stage 1 Thermal Shutdown Protection to guard against overheating caused by excessive current flow. If the motor has no power and the VXL-3m is very hot, the VXL-3m has entered Stage 2 Thermal Shutdown Protection and has automatically shut down. Let the VXL-3m cool. Make sure your model is properly geared for the conditions (see page 26).
- ✶ **Slow Blinking Red (with Low-Voltage Detection on):** The VXL-3m has entered Low-Voltage Protection. When the battery voltage begins to reach the minimum recommended discharge voltage threshold for LiPo battery packs, the VXL-3m will limit the power output to 50% throttle. When the battery voltage attempts to fall below the minimum threshold, the VXL-3m will shut down all motor output. The LED on the speed control will slowly blink red, indicating a low-voltage shutdown. The VXL-3m will stay in this mode until a fully charged battery is connected.
- ✶ **Alternating: Blinks Red then Green:** If the motor has no power, the VXL-3m has entered Over Voltage Protection. If a battery with too high voltage is used, the VXL-3m will go into a fail-safe mode. **Warning:** If input voltage exceeds approximately 20 volts, the ESC may be damaged. Maximum peak input voltage limits are 12.6V in LiPo Mode (see page 19) and 18V in NiMH Mode.

The electronic speed control is factory set and should not require any adjustments. These instructions are provided for your reference.

## Setup Programming (Calibrating your ESC and transmitter)

Read through all of the following programming steps before you begin. If you get lost during programming or receive unexpected results, simply unplug the battery, wait a few seconds, plug the battery back in, and start over.

1. Disconnect each of the motor wires between the ESC and the motor. This is a precaution to prevent runaway when the speed control is turned on before it is programmed.
2. Connect a fully charged battery pack to the ESC.
3. Turn on the transmitter (with the throttle at neutral).
4. Press and hold the EZ-Set button (A). The LED will first turn green and then red. Release the EZ-Set button.
5. When the LED blinks RED ONCE, pull the throttle trigger to the full throttle position and hold it there (B).
6. When the LED blinks RED TWICE, push the throttle trigger to the full reverse and hold it there (C).
7. When the LED starts flashing GREEN, programming is complete. After the throttle is returned to neutral, the LED will then shine solid green or red (depending on the Low-Voltage Detection setting) indicating the VXL-3m is on and at neutral (D).



## ESC Operation

**Note:** In steps 1-7 below, Low-Voltage Detection is turned off (factory default) and the LED shines RED. If Low-Voltage Detection is on, the LED will shine GREEN instead of RED in steps 1-7 below.

To operate the speed control and test the programming, place the vehicle on a stable block or stand so all of the drive wheels are off the ground. Reconnect the motor wires. Always make sure that objects and fingers are clear of the wheels.

1. With the transmitter on, press the EZ-Set button for ½ second, until the LED shines GREEN, then immediately release the button. This turns on the ESC. If you press and release too quickly, you may hear the steering servos jump, but the LED may not stay on.
2. Apply forward throttle. The LED will turn off until full throttle power is reached. At full throttle, the led will shine RED.
3. Move the trigger forward to apply the brakes. Note that braking control is fully proportional. The LED will turn off until full braking power is reached. At full brakes, the LED will shine RED.
4. Return the throttle trigger to neutral. The LED will shine RED.
5. Move the throttle trigger forward again to engage reverse (Profile #1). The LED will turn off. Once full reverse power is reached, the LED will shine RED.
6. To stop, return the throttle trigger to neutral.
7. To turn the ESC off, press the EZ-Set button until the RED LED turns off.

## VXL-3m Thermal Shutdown Protection

The VXL-3m is also equipped with thermal shutdown protection. If the operating temperature exceeds safe limits, the ESC will reduce power to 50% and the LED will flash red. Additional heating will cause the speed control to shut down completely until it reaches a safe operating temperature. Traxxas encourages you to stop driving as soon as the thermal overload protection is activated.

## ESC Profile Selection

The speed control is factory set to Profile #1. To change the profile, follow the steps described on the next page. The speed control should be connected to the receiver and battery, and the transmitter should be adjusted as described previously. The profiles are selected by entering the programming mode.

**ESC Profile Description**

- Profile #1 (Sport Mode):** 100% Forward, 100% Brakes, 100% Reverse
- Profile #2 (Race Mode):** 100% Forward, 100% Brakes, No Reverse
- Profile #3 (Training Mode):** 50% Forward, 100% Brakes, 50% Reverse

**Selecting Sport Mode (Profile #1)**

1. Connect a fully charged battery pack to the ESC and turn on your transmitter.
2. With the ESC off, press and hold the EZ-Set button until the light turns solid green, then solid red, and then begins blinking red (indicating the Profile numbers).
3. When the light blinks red once, release the EZ-Set button.
4. The light will then turn red and the model is ready to drive.

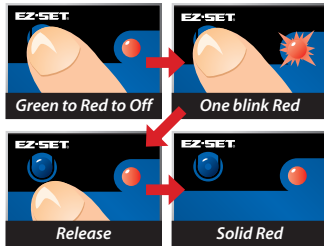

**Selecting Race Mode (Profile #2)**

1. Connect a fully charged battery pack to the ESC and turn on your transmitter.
2. With the ESC off, press and hold the EZ-Set button until the light turns solid green, then solid red, and then begins blinking red (indicating the Profile numbers).
3. When the light blinks red twice, release the EZ-Set button.
4. The light will then turn red and the model is ready to drive.

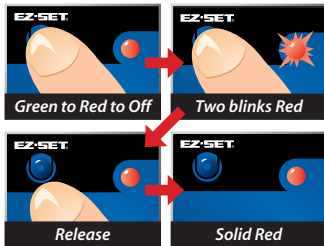

**Selecting Training Mode\* (Profile #3)**

1. Connect a fully charged battery pack to the ESC and turn on your transmitter.
2. With the ESC off, press and hold the EZ-Set button until the light turns solid green, then solid red, and then begins blinking red (indicating the Profile numbers).

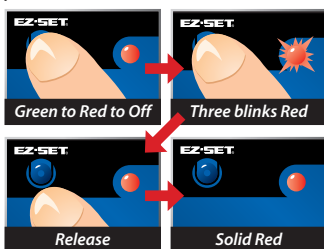

3. When the light blinks red three times, release the EZ-Set button.
4. The light will then turn red and the model is ready to drive.

*Note: If you missed the mode you wanted, keep the EZ-Set button pressed down and the blink cycle will repeat until a Mode is selected.*

**LiPo Battery Mode with Low-Voltage Detection**

The VXL-3m ESC is equipped with built-in Low-Voltage Detection for safe use with Lithium Polymer (LiPo) batteries. The Low-Voltage Detection circuitry constantly monitors the battery voltage. When the battery voltage begins to reach the minimum recommended discharge voltage threshold for LiPo battery packs, the VXL-3m will limit the power output to 50% throttle. When the battery voltage attempts to fall below the minimum threshold, the VXL-3m will shut down all motor output. The LED on the speed control will slowly blink red, indicating a low-voltage shutdown. The VXL-3m will stay in this mode until a fully charged battery is connected. The electronic speed control is factory set with Low-Voltage Detection disabled. **Be certain to activate Low-Voltage Detection if you install LiPo batteries in your model.**

**To activate Low-Voltage Detection (LiPo setting):**

1. Make sure the LED on the ESC is on and red.
2. Press and hold the EZ-Set button for ten seconds. The LED will turn off and then light green. Also, a “rising” musical tone will be emitted from the motor.
3. Low-Voltage Detection is now ACTIVATED.

**To disable Low-Voltage Detection (NiMH setting):**

1. Make sure the LED on the ESC is on and green.
2. Press and hold the EZ-Set button for ten seconds. The LED will turn off and then light red. Also, a “falling” musical tone will be emitted from the motor.
3. Low-Voltage Detection is now DISABLED.

**Never use LiPo batteries while Low-Voltage Detection is disabled.**



**Patented Training Mode (Profile #3)** reduces forward and reverse throttle by 50%. Training Mode is provided to reduce the power output, allowing beginning drivers to better control the model. As driving skills improve, simply change to Sport or Race Mode for full-power operation.



**Tip For Fast Mode Changes**  
The ESC is set to Profile 1 (Sport Mode) as the default. To quickly change to Profile 3 (Training Mode), with the transmitter on and the ESC turned off, press and hold the SET button until the light blinks red three times and then release. For full power, turn off the ESC then quickly change back to Profile 1 (Sport Mode) by pressing and holding the SET button until the light blinks red one time and then releasing.

## DRIVING YOUR MODEL

Now it's time to have some fun! This section contains instructions on driving and making adjustments to your model. Before you go on, here are some important precautions to keep in mind.

- Allow the model to cool for a few minutes between runs. This is particularly important when using high-capacity battery packs that allow extended periods of running. Monitoring temperatures will extend the lives of the battery and motor.
- Do not continue to operate the model with low batteries or you could lose control of it. Indications of low battery power include slow operation and sluggish servos (slow to return to center). Stop immediately at the first sign of weak batteries. When the batteries in the transmitter become weak, the red power light will begin to flash. Stop immediately and install new batteries.
- Do not drive the model at night, on public streets, or in large crowds of people.
- If the model becomes stuck against an object, do not continue to run the motor. Remove the obstruction before continuing. Do not push or pull objects with the model.
- Because the model is controlled by radio, it is subject to radio interference from many sources beyond your control. Since radio interference can cause momentary losses of control, allow a safety margin of space in all directions around the model in order to prevent collisions.
- Use good, common sense whenever you are driving your model. Intentionally driving in an abusive and rough manner will only result in poor performance and broken parts. Take care of your model so that you can enjoy it for a long time to come.
- High-performance vehicles produce small vibrations which may loosen hardware over time. Frequently check wheel nuts and other screws on your vehicle to ensure that all hardware remains properly tightened.

### About Run Time

A large factor affecting run time is the type and condition of your batteries. The milliamp hour (mAh) rating of the batteries determines how large their "fuel tank" is. A 2000 mAh battery pack will theoretically run twice as long as a 1000 mAh pack. Because of the wide variation in the types of batteries that are available and the methods with which they can be charged, it's impossible to give exact run times for the model.

Another major factor that affects run time is how the model is driven. Run times may decrease when the model is driven repetitively from a stop to top speed and with repetitive hard acceleration.

### Tips for Increasing Run Time

- Use batteries with the highest mAh rating you can purchase.
- Use the included charger or a high-quality peak-detecting charger.
- Read and follow all maintenance and care instructions provided by the manufacturer of your batteries and charger.
- Keep the ESC cool. Get plenty of airflow across the ESC heat sinks.
- Lower your gear ratio. Installing smaller pinion gears will lower your gear ratio and cause less power draw from the motor and batteries, and reduce overall operating temperatures.
- Maintain your model. Do not allow dirt or damaged parts to cause binding in the drivetrain. Keep the motor clean.

### mAh Ratings and Power Output

The mAh rating of the battery can affect your top speed performance. The higher capacity battery packs experience less voltage drop under heavy load than low mAh rated packs. The higher voltage potential allows increased speed until the battery begins to become discharged.

### RUNNING IN WET CONDITIONS

Your model is designed with water-resistant features to protect the electronics in the model (receiver, servos, electronic speed control). This gives you the freedom to have fun driving your model through puddles, wet grass, snow, and other wet conditions. Though highly water resistant, the model should not be treated as though it is submersible or totally, 100% waterproof. Water resistance applies only to the installed electronic components. Running in wet conditions requires additional care and maintenance for the mechanical and electrical components to prevent corrosion of metal parts and maintain their proper function.

### Precautions

- **Without proper care, some parts of your model can be seriously damaged due to contact with water. Know that additional maintenance procedures will be required after running in wet conditions in order to maintain the performance of your model. Do not run your model in wet conditions if you are not willing to accept the additional care and maintenance responsibilities.**



- Not all batteries can be used in wet environments. Consult your battery manufacturer to see if their batteries can be used in wet conditions.
- The Traxxas TQi transmitter is not water resistant. Do not subject it to wet conditions such as rain.
- Do NOT operate your model during a rain storm or other inclement weather where lightning may be present.
- Do NOT allow your model to come in contact with salt water (ocean water), brackish water (between fresh water and ocean water), or other contaminated water. Salt water is highly conductive and highly corrosive. Use caution if you plan to run your model on or near a beach.
- Even casual water contact can reduce the life of your motor. Special care must be taken to modify your gearing and/or your driving style in wet conditions to extend the life of the motor (details below).

#### Before Running Your Vehicle in Wet Conditions

1. Consult the section "After Running Your Vehicle in Wet Conditions" before proceeding. Make sure you understand the additional maintenance required with wet running.
2. The wheels have small holes molded in to allow air to enter and exit the tire during normal running. Water will enter these holes and get trapped inside the tires if holes are not cut in the tires. Cut two small holes (4mm or 3/16" diameter) in each tire. Each hole should be near the tire centerline, 180 degrees apart.
3. Confirm that the receiver box O-ring and cover are installed correctly and secure. Make sure the screws are tight and the blue O-ring is not visible protruding from the edge of the cover.
4. Confirm that your batteries can be used in wet conditions.
5. Use lower gearing (smaller pinion gears) when running in mud, deep puddles, snow, or other similar situations that will restrict the tires and put much higher loads on the motor.

#### Motor Precautions

- Motor life can be greatly reduced in mud and water. If the motor gets excessively wet or submerged, use very light throttle (run the motor slowly) until the excess water can run out. Applying full throttle to a motor full of water can cause rapid motor failure. Your driving habits will determine motor life with a wet motor. Do not submerge the motor under water.

- Do not gear the motor by temperature when running in wet conditions. The motor will be cooled by water contact and will not give an accurate indication of appropriate gearing.

#### After Running Your Vehicle in Wet Conditions

1. Drain the tires by spinning the tires at full throttle to "sling" the water out. An easy way to do this is to remove the body and set the truck upside down on a flat surface. Apply full throttle so the tires spin and throw the excess water out of the holes you cut into the tires.
2. Remove the battery.
3. Rinse excess dirt and mud off the truck with low-pressure water, such as from a garden hose. Do NOT use a pressure washer or other high-pressure water. Avoid directing water into the bearings, transmission, differentials, etc.
4. Blow off the truck with compressed air (optional, but recommended). Wear safety glasses when using compressed air.
5. Remove the wheels from the truck.
6. Spray all the bearings, drivetrain, and fasteners with WD-40® or similar water displacing light oil.
7. Let the truck stand or you may blow off with compressed air. Placing the truck in a warm, sunny spot will aid drying. Trapped water and oil will continue to drip from the truck for a few hours. Place it on a towel or piece of cardboard to protect the surface underneath.
8. As a precautionary step, remove the sealed receiver box cover. While unlikely, humidity or tiny amounts of moisture or condensation may enter the receiver box during wet running. This can cause long-term problems with the sensitive electronics in the receiver. Removing the receiver box cover during storage allows the air inside to dry. This step can improve the long-term reliability of the receiver. It is not necessary to remove the receiver or unplug any of the wires.
9. **Additional Maintenance:** Increase your frequency of disassembly, inspection, and lubrication of the following items. This is necessary after extended wet use or if the vehicle will not be used for an extended period of time (such as a week or longer). This additional maintenance is needed to prevent any trapped moisture from corroding internal steel components.
  - **Stub axle housing bearings:** Remove, clean, and re-oil the bearings.
  - **Front and rear differential:** Remove, disassemble, clean, and re-grease the differentials. Refer to your exploded view diagrams for help with disassembly and reassembly.

- **Transmission:** Remove, disassemble, and clean the transmission components. No grease is required for the nylon gears. Refer to your exploded view diagrams for help with disassembly and reassembly.
- **Motor:** Remove the motor, clean with aerosol motor cleaner, and re-oil the bearings (Velineon 380 motor) with lightweight motor oil. Be sure to wear eye protection when using spray aerosol cleaners.



**RECEIVER BOX:  
MAINTAINING A WATERTIGHT SEAL**

**Removing and Installing Radio Gear**

The unique design of the receiver box allows the removal and installation of the receiver without losing the ability to maintain a watertight seal in the box. The patent-pending wire clamp feature gives you the ability to also install aftermarket radio systems and maintain the watertight features of the receiver box.

**Removing the Receiver**

1. Remove the 2.5x8mm screws that secure the wire clamp.
2. Remove the 2.5x8mm screws that secure the receiver box cover to the chassis. Lift the cover up and toward you to disengage the cover's tab from its slot in the chassis.
3. You can now access the receiver. Unplug the servo cables from the receiver and remove the receiver.

**Receiver Installation**

1. Route the antenna wire out of the receiver box cover (A). Place the cover on the chassis.
2. Route the servo and speed control leads into the receiver box cover. Use the molded-in wire guides to align the servo and speed control leads and antenna wire (B).
3. Apply a small bead of silicone grease (part #1647) to the wire clamp (C).
4. Install the wire clamp and tighten the two 2.5x8mm screws securely (D).

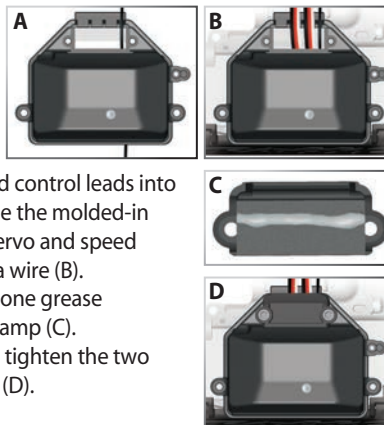

5. Lift the receiver box cover. Using double-sided adhesive foam tape, install the receiver into the box.

**Note:** For best performance, it is recommended that the receiver be installed in the original orientation as shown.

6. Plug the servo and speed control leads into the receiver (E). Refer to page 12 for the wiring diagram.
7. Bundle the wires so they fit beneath the receiver box cover.
8. Make sure the clear plastic light pipe in the receiver box is aligned above the LED on the receiver.
9. Make sure the blue O-ring is properly seated into the groove around the receiver cover base so the cover will not pinch or damage the O-ring. Snap the receiver box cover into place (F).
10. Inspect the cover to make sure the O-ring is not visible. If it is, remove the cover and reposition the O-ring. With the O-ring and cover properly seated, install the 2.5x8mm screws and tighten them securely (G).

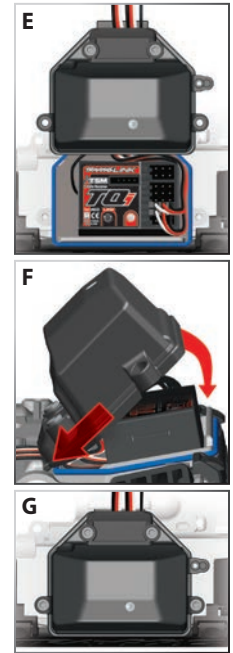

## TUNING ADJUSTMENTS

Your model is factory-tuned for optimum performance on pavement and concrete surfaces. To tailor the performance and handling of your model to suit your driving style and available traction, your model has a number of adjustable features. Gearing, shock preload and damping, ride height, wheel toe and wheel camber can all be easily adjusted.

### SUSPENSION TUNING

#### Ride Height Adjustment

Your model has threaded shock bodies that make it easy to adjust ride height. Threading the shocks' preload collars away from the caps will raise the vehicle's ride height (the distance from the chassis to the ground), and reduce the suspension's down travel, also known as 'sag' or 'droop'. This can be helpful on rough surfaces where extra ground clearance is needed. However, the vehicle's center of gravity (CG) will be raised, making it less stable.

Threading the shocks' preload collars toward the caps will lower the vehicle's ride height and increase the suspension's droop. This will lower the vehicle's CG and improve handling, but it will also reduce ground clearance.

From the factory, your model is set up as shown in the illustration above. At rest, the suspension sags to about 1/2 of its total travel. This allows the suspension to extend so the wheel can drop into depressions over rough surfaces. This leaves 1/2 of the total suspension travel for compression when absorbing bumps. These settings are ideal for most flat surfaces, and only small changes in ride height should be required to fine-tune the vehicle's handling for your particular surface.

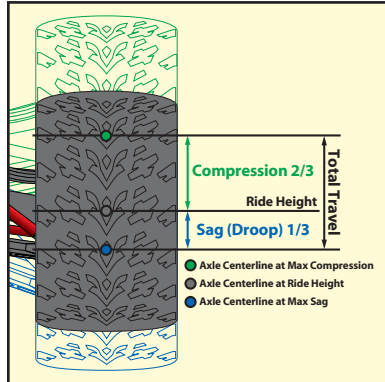

#### Shock Oil

The 4 oil-filled shocks (dampers) effectively control the suspension movement by preventing the wheels and tires from continuing to "bounce" after rebounding from a bump. Changing the oil in the shocks can vary the suspension damping effect. Changing the oil to a higher viscosity oil will increase damping. Lowering the viscosity of the oil will cause the suspension damping to be reduced. Damping should be increased (with higher viscosity oil) if the model is bottoming easily over bumps. Damping should be decreased (with thinner viscosity oil) if the model is hopping over small bumps and feels unstable. The viscosity of shock oil is affected by extremes in operating temperature; an oil of certain viscosity will become less viscous at higher temperatures and more viscous at lower temperatures. Operating in regions with cold temperatures may require lower viscosity oil. Your model's shocks are filled with SAE 40W oil. Only use 100% silicone oil in the shock.

#### Replacing Shock Oil

The shocks have to be removed from the vehicle and disassembled to change the oil.

1. Remove the lower spring retainer and shock spring.
2. Remove the upper shock cap. If you cannot unscrew the cap with your fingers, pass the 2mm "L" wrench through the cap's eyelet so you can apply more leverage. Turn the cap counterclockwise to loosen it.
3. Empty the used shock oil from the shock body.
4. Fill the shock with new silicone shock oil up to the top of the shock body.
5. Slowly move the piston up and down (always keeping it submerged in oil) to release the air bubbles. Let the shock sit for a few minutes to allow any remaining air bubbles to surface.
6. Slowly thread the upper cap with the installed shock bladder onto the shock body. The excess oil will bleed out of the small hole in the shock cap.
7. Tighten the shock cap until snug.

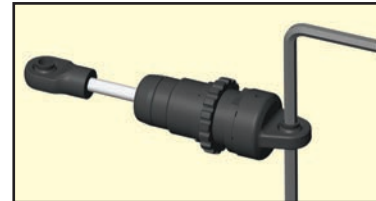

**Important:** The shocks are assembled at the factory with a center-to-center distance (between the rod end balls) of 47.75mm. Any time the shocks are removed and disassembled, this distance should be checked to ensure proper operation of the suspension.





A camber gauge (available at your local hobby shop) can be a useful tool for alignment setting.



To achieve a good starting point for the slipper clutch, tighten the slipper clutch adjusting nut clockwise until the slipper clutch adjusting spring fully collapses (do not over tighten), and then turn the slipper clutch nut counterclockwise  $\frac{3}{4}$  to 1 turn.

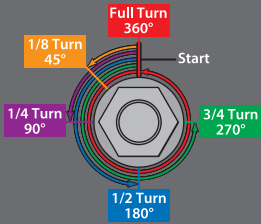

### Static Camber Adjustment

The wheels can be set to have either positive or negative camber (see illustration below). The camber angle changes as the wheel moves up and down through its range of travel. Static camber is the camber angle at the wheel when the vehicle is set at its normal, stationary ride height.

The suspension pivot balls located in the axle carriers adjust the static camber. Camber is factory-set at  $-2^\circ$ . To adjust static camber, insert the supplied 2mm hex wrench into the pivot ball (compressing the suspension until the arms are parallel to the ground will allow for easier hex wrench engagement).



Negative camber can be increased by unthreading the lower pivot ball. Zero camber or positive camber (not recommended) can be achieved by unthreading the upper pivot ball. Note that camber changes will also effect the toe angle of the wheel being adjusted.

### Static Camber Base Factory Settings

Front:  $-2^\circ$  camber each side

Rear:  $-2^\circ$  camber each side

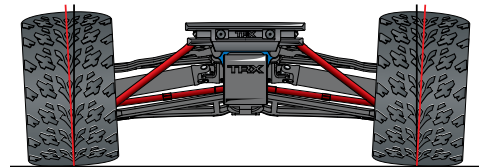

### Positive camber

Wheels lean out, away from chassis

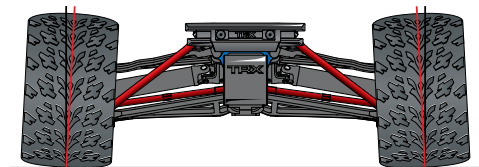

### Negative camber

Wheels lean in, toward chassis

### Adjusting Toe-In

Toe-in refers to the angle of the front and rear wheels as viewed from above (see the diagram below). The handling of your model can be adjusted by altering the front and rear toe angles.

### Front Toe Adjustment:

The toe-in of your model's front wheels can be adjusted by threading the front pivot balls in or out of the suspension arms. Threading the upper and lower pivot balls into the arms (by turning them clockwise) will increase toe-in. Threading the pivot balls out of the arms (by turning them counterclockwise) will reduce toe-in. Front toe-in increases straight line stability and will help the model to self-correct to a straight path when transitioning from turns to straight-aways. Decreasing front toe-in or using toe-out will reduce straight-line stability, but will make the model's handling feel more aggressive when initiating a turn.

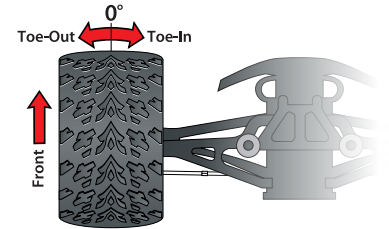

### Rear Toe Adjustment:

Rear toe-in is adjusted in the same way as front toe-in, by adjusting the depth of the pivot balls in the arms. Increasing rear toe-in will add stability to the model and make the model handle less aggressively (to use racing terminology, the model will have "less steering"). Reducing toe-in will "loosen" the rear of the model, making it more likely to spin-out (oversteer). Rear toe-out is not recommended, as it will cause erratic handling.

For maximum adjustability, Traxxas offers threaded aluminum toe links (part #7138X) for your model.



## TRANSMISSION TUNING

### Adjusting the Slipper Clutch

Your model is equipped with an adjustable Torque Control slipper clutch, which is built into the large spur gear. The purpose of the slipper clutch is to prevent over-stressing of the drivetrain and transmission gears. It may also be used to regulate the amount of power sent to the rear wheels to prevent tire spin. When it slips, the slipper clutch makes a high-pitch, whining noise.

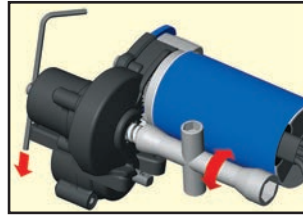

To adjust the slipper clutch, remove the receiver box cover. The slipper clutch is integrated into the main spur gear on the transmission. The slipper clutch is adjusted using the spring-loaded locknut on the slipper shaft. Use the supplied universal wrench. To tighten or loosen the slipper nut, insert the 1.5mm hex wrench into the hole in the end of the slipper shaft. This locks the shaft for adjustments. Turn the adjustment nut clockwise to tighten (less slippage) and counterclockwise to loosen (more slippage).

### Tuning the Sealed Gear Differentials

Your model is equipped with sealed, bevel gear differentials. The differentials allow the left and right wheels to spin at different speeds while turning. You can increase or decrease the torque transmitted between the left and right wheels by changing the viscosity of the silicone oil inside the differentials. The viscosity of the oil is indicated as a weight (W). Higher weights are more viscous, meaning the oil is “thicker.” Lower weight numbers are less viscous, meaning the oil is “thinner.” Filling the differential with higher viscosity (thicker) oil “tightens” the differential, transferring more power to the wheel with the most traction. Filling the differentials with lower viscosity (thinner) oil “loosens” the differential, transferring less power to the wheel with the most traction. Traxxas sells a variety of differential tuning oils specifically designed for use in your model.

Your model’s gear differentials have been tuned specifically to provide balanced handling and precision power slides. The front differential has been filled from the factory with high-viscosity 50,000W silicone oil. The 50,000W oil allows the front wheels to pull the model through the turn when counter steering through a drift. Increasing the fluid viscosity increases the authority of the steering while drifting, but decreases the steering when not drifting (“grip driving”). Increasing the front differential viscosity too much will make the model difficult to drive (“twitchy”). Decreasing the front differential viscosity will decrease the ability of the model to drift, but will increase steering response when grip driving.

#### Front Differential oil viscosity tuning suggestions

- For drift cornering with a single Series 1 battery (6-cell NiMH), use the stock differential oil.
- For drift cornering with dual Series 1 batteries (12-cell NiMH), use thicker/higher viscosity differential oil (higher weight number).
- For grip driving with single or dual batteries, use thinner/ lower viscosity differential oil (lower weight number).

Tuning the rear differential fluid will allow you to fine tune the amount of angle the model will exhibit during a drift. The rear differential is filled with 30,000W oil to keep the rear of the model from sliding out completely when drifting around a turn. Increasing the viscosity of the fluid will cause the model to over-rotate resulting in a spin. Decreasing the viscosity of the fluid will reduce the model’s drift angle. For grip driving, lowering the viscosity will allow the model to turn more easily.

#### Rear Differential oil viscosity tuning suggestions

- For drift cornering with a single Series 1 battery (6-cell NiMH), use the stock differential oil.
- For drift cornering with dual Series 1 batteries (12-cell NiMH), use thicker/higher viscosity differential oil (higher weight number).
- For grip driving with single or dual batteries, use thinner/ lower viscosity differential oil (lower weight number).

**Gearing Compatibility Chart**

This chart shows a full range of gear combinations. The gear combinations in gray are not suitable when using the included 6-cell battery, speed control, and motor. These gear combinations have been included in this chart as they may be used with certain other aftermarket equipment combinations.

Pinion Gear	Spur Gear		
	45	50	55
11	-	-	25.20
12	-	-	23.10
13	-	-	21.32
14	-	-	19.80
15	-	-	18.48
16	-	15.75	17.33
17	-	14.82	16.31
18	-	14.00	15.40
19	-	13.26	14.59
20	-	12.60	13.86
21	10.80	12.00	13.20
22	10.31	11.45	12.60
23	9.86	10.96	12.05
24	9.45	10.50	11.55
25	9.07	10.08	11.09
26	8.72	9.69	10.66
27	8.40	9.33	10.27
28	8.10	9.00	9.90
29	7.82	8.69	9.56
30	7.56	8.40	9.24
31	7.32	8.13	8.94

- Stock
- Acceptable range for included single battery
- Acceptable range for included single battery/ Recommended range for dual batteries using series connector (Part #3063, sold separately)
- High Speed Gearing for dual batteries using series connector (Part #3063, sold separately)
- Not suitable for stock model

**MOTOR AND GEARING**

Extensive testing has been done to determine the best gear ratio for your model. The stock gearing balances power, speed, and efficiency to optimize the performance of the model. However, you may wish to try different gear ratios in order to customize the performance of your model. The gearing chart on this page shows appropriate gearing for the model.

By installing a pinion with fewer teeth, or a spur gear with more teeth, the transmission's final drive ratio is increased. This means greater rpm is required to achieve a given speed. Using a numerically higher gear ratio will increase torque, but reduce top speed. Installing a pinion with more teeth, or a spur gear with fewer teeth, will decrease the final drive ratio, which will generally increase top speed but reduce torque. However, installing too large a pinion will "overgear" the model, which will reduce performance and may overheat the motor and speed control. Use the following formula to calculate the overall ratio for combinations not listed on the gear chart:

$$\frac{\# \text{ Spur Gear Teeth}}{\# \text{ Pinion Gear Teeth}} \times 5.04 = \text{Final Gear Ratio}$$

**Motor Installation**

To access the motor, remove the gear cover by removing the single screw on the top of the gear cover. The motor uses an aluminum mount for quick, easy motor access and gearing adjustment. To remove the motor, first open the right battery door and slide out the ESC. Next, remove the single large hex screw using the supplied 2.5mm wrench. Then rotate the motor and mount to the side of the model, and slide backward off the post.

The motor mount is carefully engineered to provide additional features and adjustability. Two sets of holes are

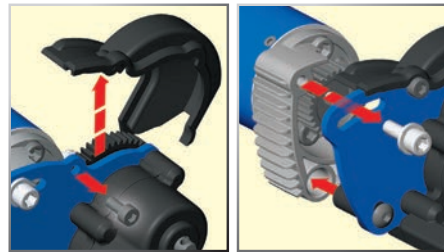

Motor Mount Positions

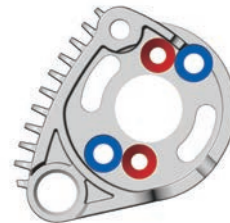

- Brushed Motors
- Brushless Motors

provided for use with brushed and brushless motors. The holes for brushed motors are spaced 16mm apart and accept 2.5mm screws. The holes for brushless motors are spaced 19mm apart and accept 3mm screws.

**Pinion Gear Installation Instructions**

1. Remove the motor as described previously in *Motor Installation*.
2. Use a 1.5mm wrench to loosen the pinion's set screw. Remove the pinion.
3. Place the replacement pinion gear onto the motor shaft. Align the set screw hole with the flat side of the shaft.
4. Thread a 1.5mm set screw into the pinion gear but do not tighten it yet.
5. Slide the pinion gear down the motor shaft so the wrench shaft fits into the notch in the motor mount, as shown. Tighten the set screw.

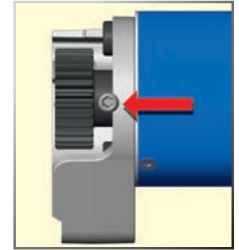

**Adjusting Gear Mesh**

Incorrect gear mesh is the most common cause of stripped spur gears. Gear mesh should be checked and adjusted anytime a gear is replaced. Access the gears by removing the single screw on the top gear cover.

To set the gear mesh, cut a narrow strip of notebook paper and run it into the gear mesh of the motor. The motor is mounted to an aluminum motor mount. Loosen the single motor mount screw with the provided 2.5mm wrench to slide the motor mount. Slide the motor and pinion gear into the spur gear. Retighten the motor mount screw and then remove the strip of paper. You should be able to run a fresh strip of paper through the gears without binding them.

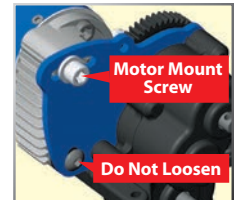

### High Speed Gearing

The included high-speed pinion gear can be installed to increase the top speed of your model to 50+mph. This also requires the use of an additional battery (sold separately) and a Traxxas series connector (Part #3063, sold separately). See page 14 for more information.

#### 50+mph Battery and Gearing Installation Instructions

1. Install the included high-speed pinion gear as described in *Pinion Gear Installation Instructions* on page 26. Install the supplied battery as described on page 14.
2. Install an identical Power Cell Series 1 battery (#2925) sold separately) in the opposite battery compartment.
3. Plug both batteries into the Y-harness (sold separately). The harness connects the two packs in series. The two 7.2-volt 6-cell battery packs will operate as one 14.4-volt 12-cell battery pack.
4. Plug the Y-harness into the speed control.



#### Precautions

- The High Speed dual-battery and gearing configuration is for high-speed running only. Avoid repetitive hard acceleration to prevent overstressing the motor, speed control, and batteries.
- Make certain both batteries are fully charged before installing them in your model. Installing a fully charged pack and a partially discharged pack may lead to over-discharging and damage to the partially discharged battery.
- Do not mix batteries of different brands, chemistries, or capacities. Only genuine Traxxas batteries are approved for dual-battery use in this model.
- Stop running your model and allow it to cool if the speed control's thermal overload protection activates or if the motor temperature exceeds 200° F.

### WHEELS AND TIRES

Your model uses 12mm axle hexes, which allow many types of aftermarket tires and wheels to be adapted for use on your model. Most will affect the overall width and the suspension geometry of the model. The offsets and dimensions designed into the model's wheels are intentional; therefore, Traxxas cannot recommend the use of other non-Traxxas wheels with different specifications. Experimentation with different types of tires is recommended to see which ones work the best on the terrain where the model is run. Soft compound tires with many short spikes generally work better on hard, dry surfaces. In loose dirt, a tire with large spikes should perform better. Foam tires can be fitted for use on pavement or indoor carpet tracks. See your parts list for accessory wheels and tires.

When selecting tires, consider the overall diameter of the tire. If the overall diameter is significantly larger than the stock tire's diameter, you will need to use a smaller pinion gear to compensate for the larger tire. If you wish to install tires with a diameter greater than 4 inches or 100mm, Traxxas suggests you configure the transmission for "underdrive" gearing. Details on making this simple modification are available at [Traxxas.com](http://Traxxas.com).



Always wear eye protection when using compressed air or spray cleaners and lubricants.

Your model requires timely maintenance in order to stay in top running condition. **The following procedures should be taken very seriously.**

**Inspect the vehicle for obvious damage or wear. Look for:**

1. Cracked, bent, or damaged parts
2. Check the wheels and steering for binding.
3. Check the operation of the shock absorbers.
4. Check the wiring for any frayed wires or loose connections.
5. Check the mounting of the receiver and servo(s) and speed control.
6. Check the tightness of the wheel nuts with a wrench.
7. Check the operation of the radio system, especially the condition of the batteries.
8. Check for any loose screws in the chassis structure or suspension.
9. Inspect the gears for wear, broken teeth, or debris lodged between the teeth.
10. Check the tightness of the slipper clutch.
11. Check the tightness of the front pivot balls.

**Other periodic maintenance:**

• **Slipper clutch pad (friction material):**

Under normal use, the friction material in the slipper clutch should wear very slowly. If the slipper clutch fails to provide consistent performance or slips even when the adjustment nut is fully tightened, disassemble the slipper clutch and replace the slipper pad. Inspect the spur gear and pressure plate for wear or damage and replace if necessary.

- **Chassis:** Keep the chassis clean of accumulated dirt and grime. Periodically inspect the chassis for damage.

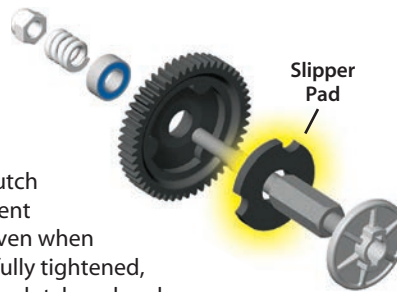

- **Shocks:** Keep the oil level in the shocks full. Use only 100% pure silicone shock oil to prolong the life of the seals. If you are experiencing leakage around the top of the shock, inspect the bladder in the top cap for signs of damage or distortion from overtightening. If the bottom of the shock is leaking, then it is time for a rebuild. The Traxxas rebuild kit for two shocks is part #7062.
- **Suspension:** Periodically inspect the model for signs of damage such as bent or dirty suspension pins, bent turnbuckles, loose screws, and any signs of stress or bending. Replace components as needed.
- **Driveline:** Inspect the driveline for signs of wear such as worn drive yokes, dirty axle half shafts, and any unusual noise or binding. Remove the gear cover. Inspect the spur gear for wear and check the tightness of set screws in the pinion gears. Tighten, clean, or replace components as needed.

**Storage**

When you are through running the model for the day, blow it off with compressed air or use a soft bristled paint brush to dust-off the vehicle. Always disconnect and remove the battery from the model whenever the model is stored. If the model will be stored for a long time, then also remove the batteries from the transmitter.

Keep this manual and the other documents included with your model for future reference. If you misplace your manual or any of the documents, they may be downloaded at [Traxxas.com](http://Traxxas.com).

If you have any questions about your model or its operation, call the Traxxas Technical Support Line toll-free at: **1-888-TRAXXAS (1-888-872-9927)\***

Technical support is available Monday through Friday from 8:30am to 9:00pm central time.

If you have questions or need technical assistance, call Traxxas at  
**1-888-TRAXXAS**  
 (1-888-872-9927) (U.S. residents only)



Your Traxxas transmitter has a programmable Multi-Function knob that can be set to control various advanced transmitter functions (set to Traxxas Stability Management (TSM) by default, see page 17). Accessing the programming menu is done by using the menu and set buttons on the transmitter and observing signals from the LED. An explanation of the menu structure follows on page 32. Experiment with the settings and features to see if they can improve your driving experience.

## Steering Sensitivity (Exponential)

The Multi-Function knob on the TQi transmitter can be set to control Steering Sensitivity (also known as exponential). The standard setting for Steering Sensitivity is “normal (zero exponential)”, with the dial full left in its range of travel. This setting provides linear servo response: the steering servo’s movement will correspond exactly with the input from the transmitter’s steering wheel. Turning the knob clockwise from the left will result in “negative exponential” and decrease steering sensitivity by making the servo less responsive near neutral, with increasing sensitivity as the servo nears the limits of its travel range. The farther you turn the knob, the more pronounced the change in steering servo movement will be. The term “exponential” comes from this effect; the servo’s travel changes exponentially relative to the input from the steering wheel. The exponential effect is indicated as a percentage—the greater the percentage, the greater the effect. The illustrations below show how this works.

**Normal Steering Sensitivity (0% exponential):** In this illustration, the steering servo’s travel (and with it, the steering motion of the model’s front wheels) corresponds precisely with the steering wheel. The ranges are exaggerated for illustrative purposes.

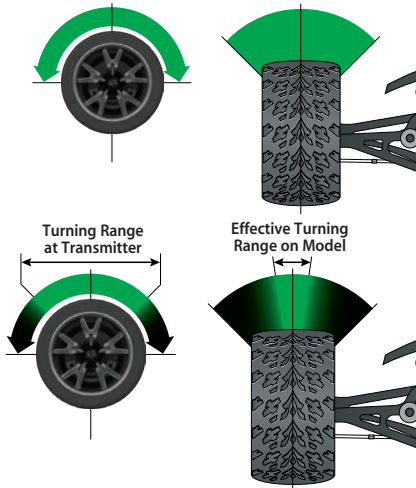

**Decreased Steering Sensitivity (Negative Exponential):** By turning the Multi-Function knob clockwise, the steering sensitivity of the model will be decreased. Note that a relatively large amount of steering wheel travel results in a smaller amount of servo travel. The farther you turn the knob, the more pronounced the effect becomes. Decreased steering sensitivity may be helpful when driving on low-traction surfaces, when driving at high speed, or on tracks that favor sweeping turns where gentle steering inputs are required. The ranges are exaggerated for illustrative purposes.

## Throttle Sensitivity (Throttle Exponential)

The Multi-Function knob can be set to control Throttle Sensitivity. Throttle Sensitivity works the same way as Steering Sensitivity, but applies the effect to the throttle channel. Only forward throttle is affected; brake/reverse travel remains linear regardless of the Throttle Sensitivity setting.

## Steering Percentage (Dual Rate)

The Multi-Function knob can be set to control the amount (percentage) of servo travel applied to steering. Turning the Multi-Function knob fully clockwise will deliver maximum steering throw; turning the knob counter-clockwise reduces steering throw (note: turning the dial counter-clockwise to its stop will eliminate all servo travel). Be aware that the steering End Point settings define the servo’s maximum steering throw. If you set Steering Percentage to 100% (by turning the Multi-Function knob fully clockwise), the servo will travel all the way to its selected end point, but not past it. Many racers set Dual Rate so they have only as much steering throw as they need for the track’s tightest turn, thus making the model easier to drive throughout the rest of the course. Reducing steering throw can also be useful in making a model easier to control on high-traction surfaces, and limiting steering output for oval racing where large amounts of steering travel are not required.

## Braking Percentage

The Multi-Function knob may also be set to control the amount of brake travel applied by the servo in a nitro-powered model. Electric models do not have a servo-operated brake, but the Braking Percentage function still operates the same way in electric models. Turning the Multi-Function knob full clockwise will deliver maximum brake throw; turning the knob counter-clockwise reduces brake throw (**Note:** Turning the dial counter-clockwise to its stop will eliminate all brake action).

## Throttle Trim

Setting the Multi-Function knob to serve as throttle trim will allow you to adjust the throttle’s neutral position to prevent unwanted brake drag or throttle application when the transmitter trigger is at neutral. **Note:** Your transmitter is equipped with a Throttle Trim Seek mode to prevent accidental runaways. See the sidebar for more information.



### Starting Over: Restoring Factory Defaults

When programming your TQi transmitter, you may feel the need to start over with a clean slate. Follow these simple steps to restore the factory settings:

1. Turn the transmitter off.
2. Hold both MENU and SET.
3. Turn the transmitter on.
4. Release MENU and SET. The transmitter LED will blink red.
5. Press SET to clear settings. The LED will turn solid green and the transmitter is restored to default.



### Throttle Trim Seek Mode

When the Multi-Function knob is set to throttle trim, the transmitter remembers the throttle trim setting. If the throttle trim knob is moved from the original setting while the transmitter is off, or while the transmitter was used to control another model, the transmitter ignores the actual position of the trim knob. This prevents the model from accidentally running away. The LED on the face of the transmitter will rapidly blink green and the throttle trim knob (Multi-Function knob) will not adjust the trim until it is moved back to its original position saved in memory. To restore throttle trim control, simply turn the Multi-Function knob either direction until the LED stops blinking.

**Failsafe**

Your Traxxas radio system is equipped with a built-in failsafe function that returns the throttle to its last saved neutral position in the event of a signal loss. The LED on the transmitter and the receiver will rapidly flash red.









**Steering and Throttle End Points**

The TQi transmitter allows you to choose the limit of the servo's travel range (or its "end point") independently for left and right travel (on the steering channel) and throttle/brake travel (on the throttle channel). This allows you to fine-tune the servo settings to prevent binding caused by the servo moving steering or throttle linkages (in the case of a nitro model) farther than their mechanical limits. The end point adjustment settings you select will represent what you wish to be the servo's maximum travel; the Steering Percentage or Braking Percentage functions will not override the End Point settings.



**Steering and Throttle Sub-Trim**

The Sub-Trim function is used to precisely set the neutral point of the steering or throttle servo in the event that simply setting the trim knob to "zero" does not completely center the servo. When selected, Sub-Trim allows finer adjustment to the servo output shaft's position for precise setting of the neutral point. Always set the Steering Trim knob to zero before making final adjustment (if required) using Sub-Trim. If Throttle Trim has been previously adjusted, the Throttle Trim will need to be reprogrammed to "zero" before making final adjustment using Sub-Trim.

**TRANSMITTER LED CODES**

LED Color / Pattern	Name	Notes
 Solid green	Normal Driving Mode	See page 15 for information on how to use your transmitter controls.
 Slow red (0.5 sec on / 0.5 sec off)	Binding	See page 17 for more information on binding.
 Flashing fast green (0.1 sec on / 0.15 sec off)	Throttle Trim Seek Mode	Turn the Multi-Function knob right or left until the LED stops flashing. See page 29 for more information.
 Flashing medium red (0.25 sec on / 0.25 sec off)	Low Battery Alarm	Put new batteries in the transmitter. See page 13 for more information.
 Flashing fast red (0.125 sec on / 0.125 sec off)	Link Failure / Error	Transmitter and receiver are no longer bound. Turn the system off and then back on to resume normal operation. Find source of the link failure (i.e., out of range, low batteries, damaged antenna).
<b>Programming Patterns</b>		
 Counts out number (green or red), then pauses	Current menu position	See Menu Tree for more information.
 X8 Fast green 8 times	Menu setting accepted (on SET)	
 X8 Fast red 8 times	Menu SET invalid	User error, such as trying to delete a locked model.

**RECEIVER LED CODES**

LED Color / Pattern	Name	Notes
 Solid green	Normal Driving Mode	See page 15 for information on how to use your transmitter controls.
 Slow red (0.5 sec on / 0.5 sec off)	Binding	See page 17 for more information on binding.
 Flashing fast red (0.125 sec on / 0.125 sec off)	Fail-Safe / Low-Voltage Detect	Consistent low voltage in the receiver triggers Fail-Safe so there is enough power to center the throttle servo before it completely loses power.

**Setting Lock**

Once you've adjusted all of these settings the way you like them, you may want to disable the Multi-Function knob so none of your settings can be changed. This is especially handy if you operate multiple vehicles with a single transmitter via Traxxas Link™ Model Memory.

**Multiple Settings and the Multi-Function Knob**

It is important to note that settings made with the Multi-Function knob are "overlaid" on top of each other. For example, if you assign the Multi-Function to adjust Steering Percentage and set it for 50%, then reassign the knob to control Steering Sensitivity, the transmitter will "remember" the Steering Percentage setting. Adjustments you make to Steering Sensitivity will be applied to the 50% steering throw setting you selected previously. Likewise, setting the Multi-Function knob to "disabled" will prevent the knob from making further adjustments, but the last setting of the Multi-Function knob will still apply.

## TRAXXAS LINK MODEL MEMORY

Traxxas Link Model Memory is an exclusive, patent-pending feature of the TQi transmitter. Each time the transmitter is bound to a new receiver, it saves that receiver in its memory, along with all the settings assigned to that receiver. When the transmitter and any bound receiver are switched on, the transmitter automatically recalls the settings for that receiver. There is no need to manually select your vehicle from a list of model memory entries.

### Model Lock

The Traxxas Link Model Memory feature can store up to thirty models (receivers) in its memory. If you bind a thirty-first receiver, Traxxas Link Model Memory will delete the “oldest” receiver from its memory (in other words, the model you used the longest time ago will be deleted). Activating Model Lock will lock the receiver in memory so it cannot be deleted.

You may also bind multiple TQi transmitters to the same model, making it possible to pick up any transmitter and any previously bound model in your collection and simply turn them on and drive. With Traxxas Link Model Memory, there is no need to remember which transmitter goes with which model, and there is never a need to have to select any model from a list of model memory entries. The transmitter and receiver do it all for you automatically.

### To activate Model Lock:

1. Switch on the transmitter and receiver you wish to lock.
  2. Press and hold MENU. Release when the status LED blinks green.
  3. Press MENU three times. The status LED will blink green four times repeatedly.
  4. Press SET. The status LED will blink green in single-flash intervals.
  5. Press SET once. The status LED will blink red once repeatedly.
  6. Press MENU once. The status LED will blink red twice repeatedly.
  7. Press SET. The LED will blink rapidly green. The memory is now locked. Press and hold MENU to return to driving mode.
- Note:** To unlock a memory, press SET twice at step 5. The LED will blink rapidly green to indicate the model is unlocked. To unlock all models, press MENU twice at step 6 and then press SET.

### To delete a model:

- At some point, you may wish to delete a model you no-longer drive from the memory.
1. Switch on the transmitter and receiver you wish to delete.
  2. Press and hold MENU. Release when the status LED blinks green.
  3. Press MENU three times. The status LED will blink green four times repeatedly.
  4. Press SET once. The status LED will blink green once repeatedly.
  5. Press MENU once. The status LED will blink green twice repeatedly.
  6. Press SET. The memory is now selected to be deleted. Press SET to delete the model. Press and hold MENU to return to driving mode.

**MENU TREE**

The Menu Tree below shows how to navigate through the TQi transmitter's various settings and functions. Press and hold MENU to enter the Menu Tree, and use the following commands to navigate through the menu and select options.

**MENU:** When you enter a menu, you always start at the top. Press MENU to move down the Menu Tree. When you reach the bottom of the tree, pressing MENU again will return you to the top.

**SET:** Press SET to move across the Menu Tree and select options. When an option is committed to the transmitter's memory, the status LED will rapidly blink green.

**BACK:** Press both MENU and SET to go back one level in the Menu Tree.

**EXIT:** Press and hold MENU to exit programming. Your selected options will be saved.

**ECHO:** Press and hold SET to activate the "echo" function. Echo will "play back" your current position on the Menu Tree should you lose your place. For example: If your current position is Steering Channel End Points, holding SET will cause the LED to blink green twice, green once, and then red three times. Echo will not alter your adjustments or change your position in the programming sequence.

Below is an example of how to access a function in the Menu Tree. In the example, the user is setting the Multi-Function knob to be a Steering % (Dual-Rate) control.

- To set the Multi-Function knob to control STEERING % (DUAL-RATE):
1. Switch the transmitter on.
  2. Press and hold MENU until the green LED lights. It will blink in single intervals.
  3. Press SET. The red LED will blink in single intervals to indicate Steering Sensitivity (Expo) has been selected.
  4. Press MENU twice. The red LED will blink three times repeatedly to indicate Steering % (Dual-Rate) has been selected.
  5. Press SET to select. The green LED will blink 8 times fast to indicate successful selection.
  6. Press and hold MENU to return to driving mode.

**Restoring Factory Defaults:**

Transmitter OFF	Hold both MENU and SET	Transmitter ON	Release MENU and SET red LED blinks	Press SET to clear settings. LED will turn solid green. Transmitter is restored to default
-----------------	------------------------	----------------	-------------------------------------	--

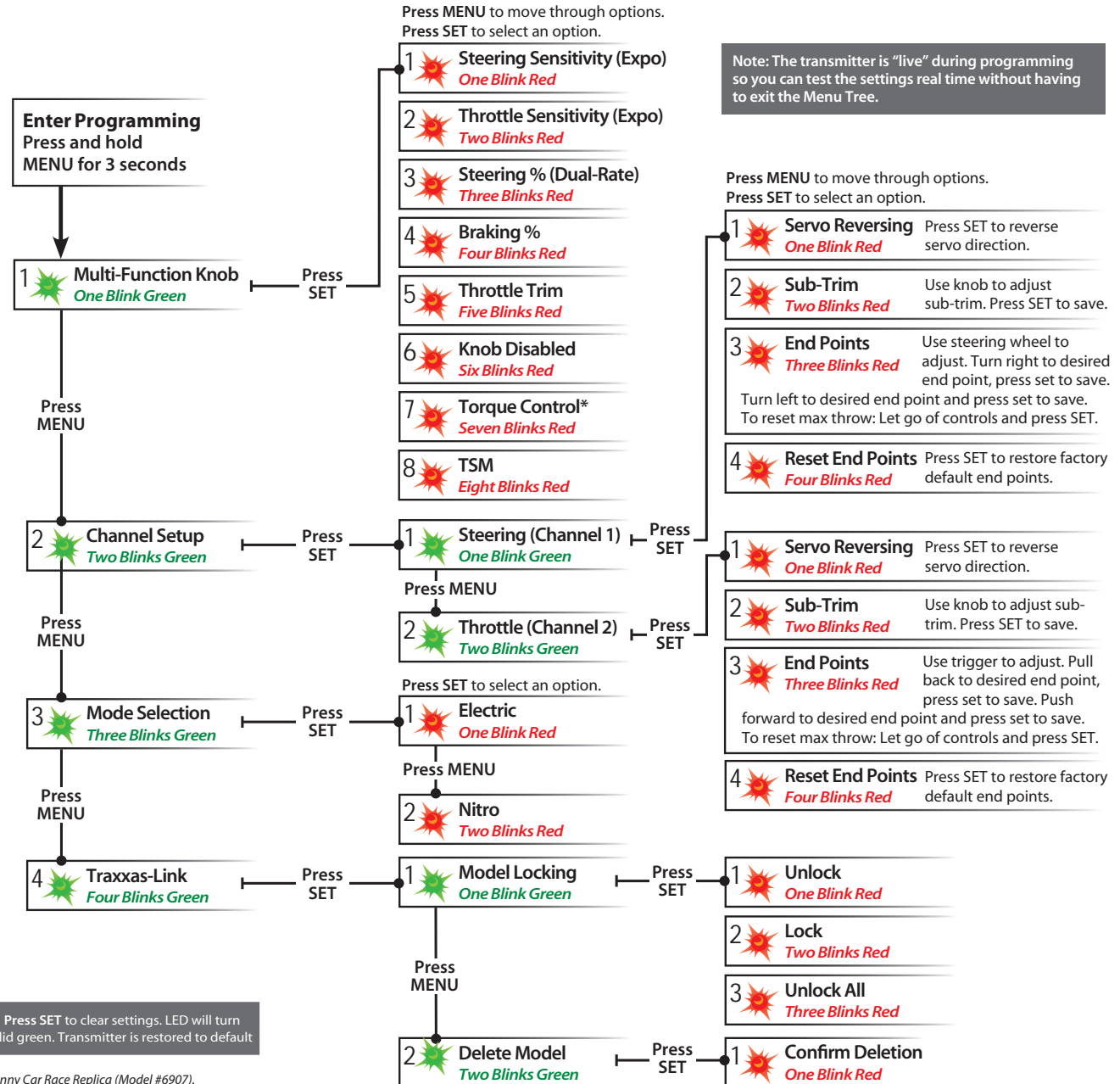

\*Torque Control is a feature designed only for use with the power system in the Traxxas Funny Car Race Replica (Model #6907).



Set Multi-Function knob for STEERING SENSITIVITY (Expo)	Press/hold MENU green LED blinks	Press SET red LED blinks	Press SET to confirm green LED blinks (x8)	Press/hold MENU returns to driving mode						
Set Multi-Function knob for THROTTLE SENSITIVITY (Expo)	Press/hold MENU green LED blinks	Press SET red LED blinks	Press MENU to confirm red LED blinks (x2)	Press SET to select green LED blinks (x8)	Press/hold MENU returns to driving mode					
Set Multi-Function knob for STEERING DUAL-RATE (%)	Press/hold MENU green LED blinks	Press SET red LED blinks	Press MENU twice red LED blinks (x3)	Press SET to select green LED blinks (x8)	Press/hold MENU returns to driving mode					
Set Multi-Function knob for BRAKING PERCENTAGE (%)	Press/hold MENU green LED blinks	Press SET red LED blinks	Press MENU 3 times red LED blinks (x4)	Press SET to select green LED blinks (x8)	Press/hold MENU returns to driving mode					
Set Multi-Function knob for THROTTLE TRIM	Press/hold MENU green LED blinks	Press SET red LED blinks	Press MENU 4 times red LED blinks (x5)	Press SET to select green LED blinks (x8)	Press/hold MENU returns to driving mode	Adjust the Multi-Function knob until the LED turns solid green.				
To LOCK the Multi-Function knob	Press/hold MENU green LED blinks	Press SET red LED blinks	Press MENU 5 times red LED blinks (x6)	Press SET to lock green LED blinks (x8)	Press/hold MENU returns to driving mode					
To REVERSE the direction of STEERING servo	Press/hold MENU green LED blinks	Press MENU green LED blinks (x2)	Press SET green LED blinks	Press SET red LED blinks	Press SET to reverse servo direction	Press/hold MENU returns to driving mode				
To set the SUB TRIM of the STEERING servo	Press/hold MENU green LED blinks	Press MENU green LED blinks (x2)	Press SET green LED blinks	Press SET red LED blinks	Press MENU red LED blinks (x2)	Use Multi-Function knob to set neutral	Press SET to save position	Press/hold MENU returns to driving mode		
To set the END POINTS of the STEERING servo	Press/hold MENU green LED blinks	Press MENU green LED blinks (x2)	Press SET green LED blinks	Press SET red LED blinks	Press MENU twice red LED blinks (x3)	Turn steering wheel to desired max left and right travel	Press SET to save each position	Turn steering wheel to test settings	IF END POINTS ARE OK: Press/hold MENU returns to driving mode	IF END POINTS NEED TO BE CHANGED: Press SET and repeat steps 6-8
To reset the END POINTS of STEERING servo to defaults	Press/hold MENU green LED blinks	Press MENU green LED blinks (x2)	Press SET green LED blinks	Press SET red LED blinks	Press MENU 3 times red LED blinks (x4)	Press SET to reset end points	Press/hold MENU returns to driving mode			
To REVERSE the direction of THROTTLE servo	Press/hold MENU green LED blinks	Press MENU green LED blinks (x2)	Press SET green LED blinks	Press MENU green LED blinks (x2)	Press SET red LED blinks	Press SET to reverse servo direction	Press/hold MENU returns to driving mode			
To set the SUB TRIM of the THROTTLE servo	Press/hold MENU green LED blinks	Press MENU green LED blinks (x2)	Press SET green LED blinks	Press MENU green LED blinks (x2)	Press SET red LED blinks	Press MENU red LED blinks (x2)	Use Multi-Function knob to set neutral	Press SET to save position	Press/hold MENU returns to driving mode	
To set the END POINTS of the THROTTLE servo	Press/hold MENU green LED blinks	Press MENU green LED blinks (x2)	Press SET green LED blinks	Press MENU green LED blinks (x2)	Press SET red LED blinks	Press MENU twice red LED blinks (x3)	Use throttle trigger to set desired max throttle or brake	Press SET to save Use trigger to test	IF END POINTS ARE OK: Press/hold MENU returns to driving mode	IF END POINTS NEED TO BE CHANGED: Press SET and repeat steps 7-9
To reset the END POINTS of THROTTLE servo to defaults	Press/hold MENU green LED blinks	Press MENU green LED blinks (x2)	Press SET green LED blinks	Press MENU green LED blinks (x2)	Press SET red LED blinks	Press MENU 3 times red LED blinks (x4)	Press SET green LED blinks (x8)	Press/hold MENU returns to driving mode		

### MENU TREE FORMULAS

To select functions and make adjustments to the TQi transmitter without referencing the Menu Tree, turn your transmitter on, find the function in the left column you wish to adjust, and simply follow the corresponding steps.



Always turn your transmitter on first.



The Traxxas Link Wireless Module is sold separately (part #6511). The Traxxas Link application is available from the Apple App store for iPhone, iPad, or iPod touch and on Google Play for Android devices. iPhone, iPad, iPod touch, or the Android device are not included with the Traxxas Link Wireless Module.

For more information about the Traxxas Link Wireless Module and the Traxxas Link application, visit [Traxxas.com](http://Traxxas.com).

**Download Now!**



## PROGRAMMING YOUR TQi TRANSMITTER WITH YOUR APPLE IPHONE, IPAD, IPOD TOUCH, OR ANDROID MOBILE DEVICE

The Traxxas Link™ Wireless Module (part #6511, sold separately) for the TQi transmitter installs in minutes to transform your Apple® iPhone®, iPad®, iPod touch®, or Android™ device into a powerful tuning tool that allows you to replace the transmitter's button/LED programming system with an intuitive, high-definition, full-color graphical user interface.



### Traxxas Link

The powerful Traxxas Link app (available in the Apple App Store™ or on Google Play™) gives you complete control over the operation and tuning of your Traxxas model with stunning visuals and absolute precision. Install Traxxas Link telemetry sensors on the model, and Traxxas Link displays real-time data such as speed, RPM, temperature, and battery voltage.



Compatible with:  
iPod touch (5th generation and later)  
iPad mini  
iPad Pro

iPad 2  
iPad Air  
iPhone 4s (and later)  
Android 4.4 (and later)

Intuitive iPhone, iPad, iPod touch, and Android interface  
Traxxas Link makes it easy to learn, understand, and access powerful tuning options. Control Drive Effects settings, such as TSM assistance percentage; steering and throttle sensitivity; steering percentage; braking strength; and throttle trim by simply touching and dragging the sliders on the screen.

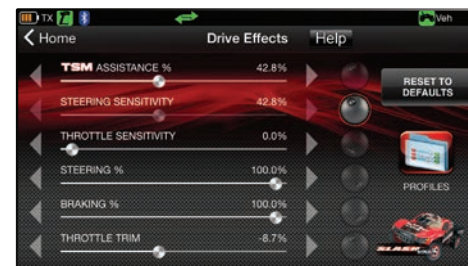

Tap and slide to adjust TSM, Steering Sensitivity, Throttle Trim, Braking Percent, and more!

### Real-Time Telemetry

When you equip your model with sensors, the Traxxas Link dashboard comes to life showing you speed, battery voltage, RPM, and temperature. Set threshold warnings and log maximums, minimums, or averages. Use the recording function to document your dashboard view, with sound, so that you can keep your eyes on your driving and not miss a single apex.



The customizable Traxxas Link dashboard delivers real-time RPM, speed, temperature, and voltage data.

### Manage up to 30 Models with Traxxas Link

The TQi radio system automatically keeps track of what vehicles it has bound to and what settings were used for each—up to 30 models total! Traxxas Link provides a visual interface to name the models, customize their settings, attach profiles, and lock them into memory. Simply choose a model and any previously bound transmitter, power them up, and start having fun.



Traxxas Link Model Memory simplifies organizing your collection of vehicles.

---

---

---

---

---

---

---

---

---

---

---

---

---

---

---

---

---

---

---

---

---

---

---

---

---

---

---

---

---

---



**1/16**  
**E REVO**  
MODEL 71076-3  
**VXL**  
BRUSHLESS

**TRAXXAS**

OWNER'S MANUAL

6250 TRAXXAS WAY, MCKINNEY, TEXAS 75070  
1-888-TRAXXAS