



Giant Scale F4U Goodyear ARF 87" FG-1D 60cc Limited Edition

Code : SEA361

ASSEMBLY MANUAL

“Graphics and specifications may change without notice”.



Specifications:

Wingspan-----	87 in-----	221 cm.
Wing area-----	2562.5 sq.ins-----	165 sq.dm.
Weight-----	30.9 lbs-----	14 kg.
Length-----	66.9 in-----	170 cm.
Engine-----	60cc.	
Motor-----	360/6000watt/ESC 200A/Lipo 12s.	
Radio-----	12 channels with 12 servos.	



INTRODUCTION

Thank you for choosing the **Giant Scale F4U Goodyear FG-1D 60cc ARF 87" Limited Edition** ARTF by **SG MODELS** . The **Giant Scale F4U Goodyear FG-1D 60cc ARF 87" Limited Edition** was designed with the intermediate/advanced sport flyer in mind. It is a semi scale airplane which is easy to fly and quick to assemble. The airframe is conventionally built using balsa, plywood to make it stronger than the average ARTF, yet the design allows the aeroplane to be kept light. You will find that most of the work has been done for you already. The motor mount has been fitted and the hinges are pre-installed. Flying the **Giant Scale F4U Goodyear FG-1D 60cc ARF 87" Limited Edition** is simply a joy.

This instruction manual is designed to help you build a great flying aeroplane. Please read this manual throughly before starting assembly of your **Giant Scale F4U Goodyear FG-1D 60cc ARF 87" Limited Edition** Use the parts listing below to indentify all parts.

WARNING

Please be aware that this aeroplane is not a toy and if assembled or used incorrectly it is capable of causing injury to people or property. WHEN YOU FLY THIS AEROPLANE YOU ASSUME ALL RISK & REponsibility.

If you are inexperienced with basic R/C flight we strongly recommend you contact your R/C supplier and join your local R/C model Flying Club. R/C Model Flying Clubs offer a variety of training procedures designed to help the new pilot on his way to successful R/C flight. They will also be able to advise on any insurance and safety regulations that may apply.

KIT CONTENTS

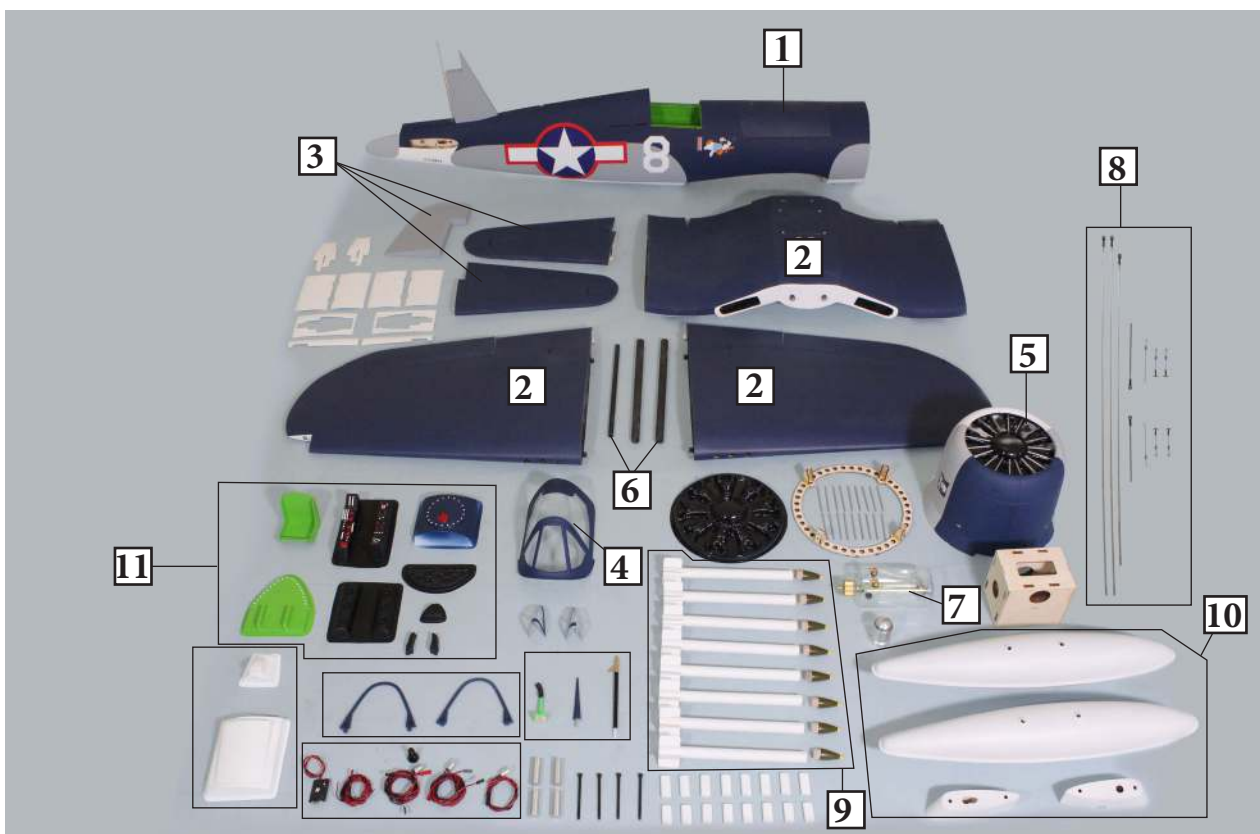

KIT CONTENTS

SEA361 Giant Scale F4U Goodyear FG-1D 60cc ARF 87" Limited Edition.

1. Fuselage
2. Wing set (3 pcs)
3. Tail set (2 pcs)
4. Canopy
5. Cowling
6. Wing tube
7. Fuel tank
8. Pushrod set
9. Rocket Set With Deluxe Model
10. Drop Tanks/Bomb W/Deluxe Model
11. Cockpit

ADDITIONAL ITEMS REQUIRED

- 60cc gasoline engine.
- Computer radio 12 channel with 12 servos.
- Glow plug to suit engine.
- Propeller to suit engine.
- Protective foam rubber for radio system.

TOOLS & SUPPLIES NEEDED

- Thin cyanoacrylate glue.
- Medium cyanoacrylate glue.
- 30 minute epoxy.
- 5 minute epoxy.
- Hand or electric drill.
- Assorted drill bits.
- Modelling knife.
- Straight edge ruler.
- 2mm ball driver.
- Phillips head screwdriver.
- 220 grit sandpaper.
- 90° square or builder's triangle.
- Wire cutters.
- Masking tape & T-pins.
- Thread-lock.
- Paper towels.

WING TIP BULBS

Please see below pictures.

1.



The Blue light for right wing tip, and the red light for left wing tip. They are designed to operate on voltages 12 volts. Connect lights into switch circuit so that optional the different flashes mode.

2.

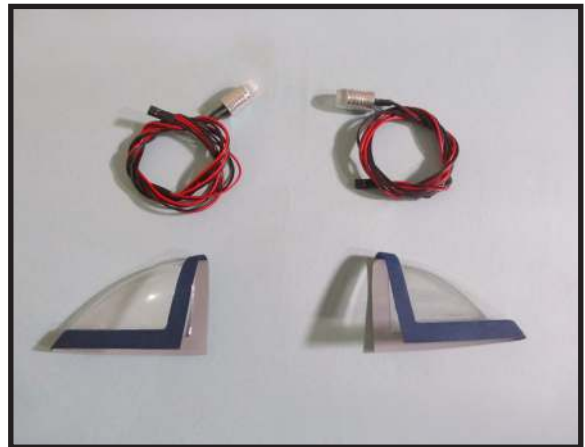

3.

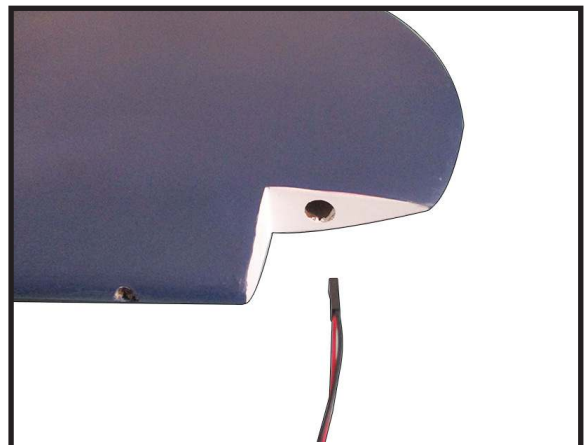

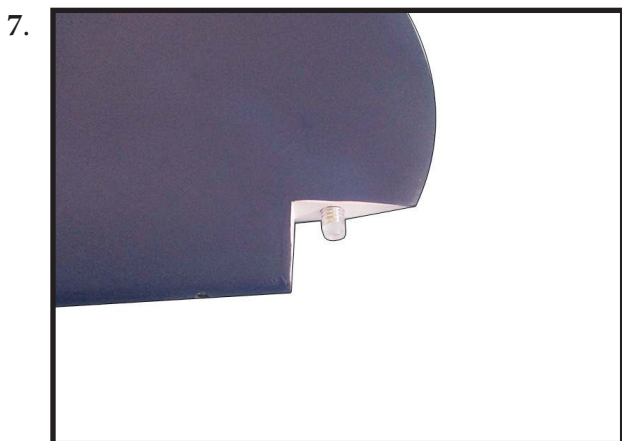
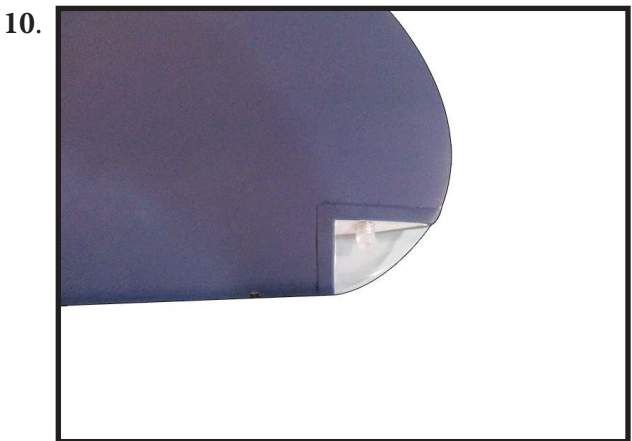
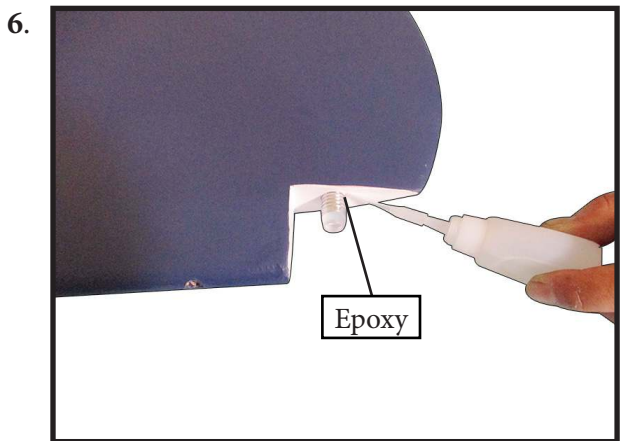
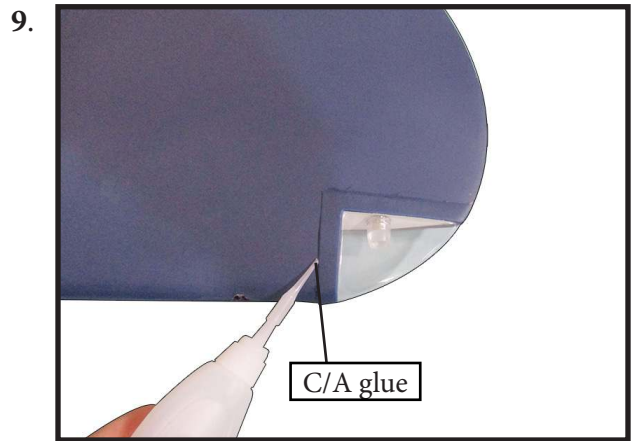
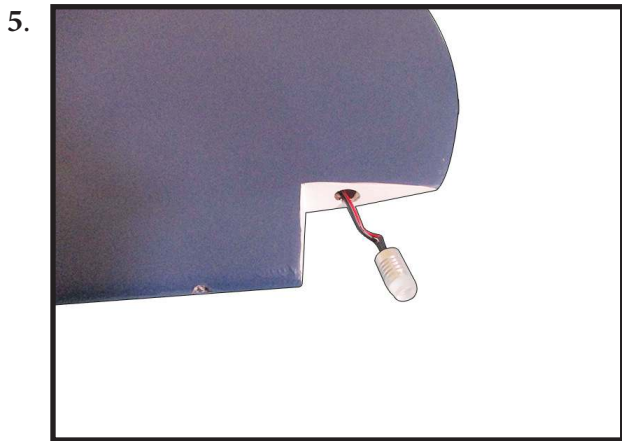
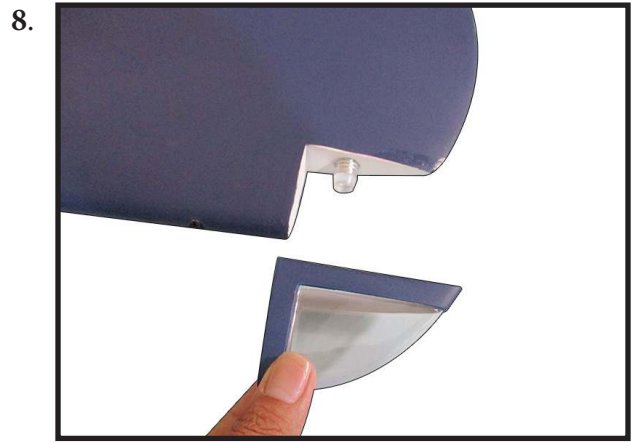
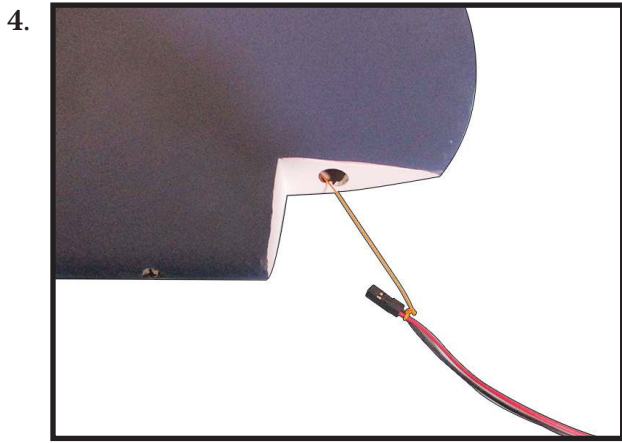

INSTALL THE AILERONS CONTROL HORN

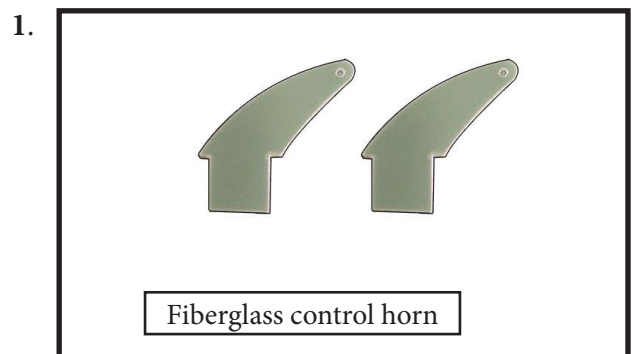

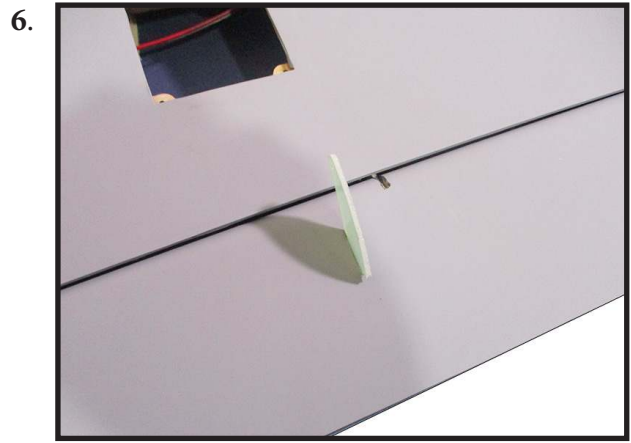
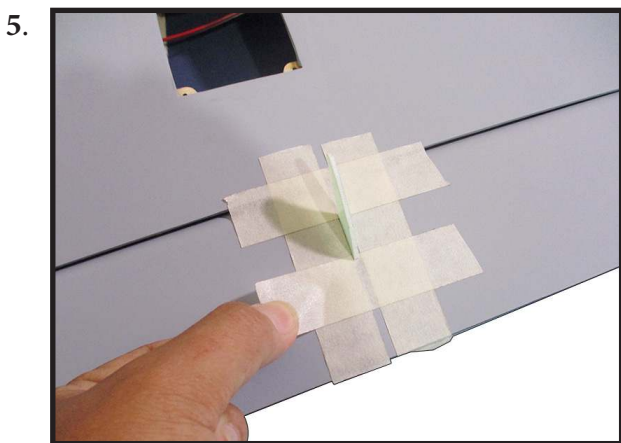
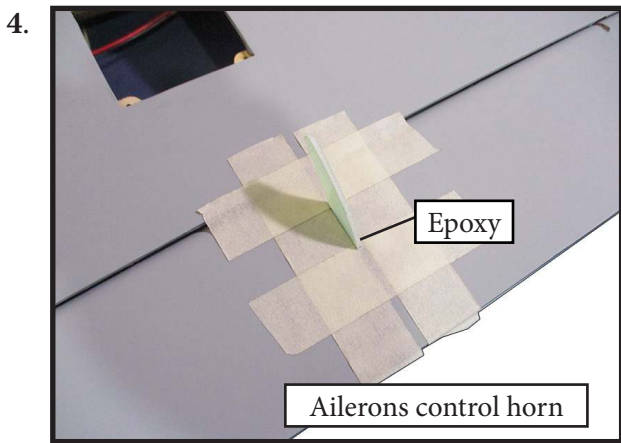
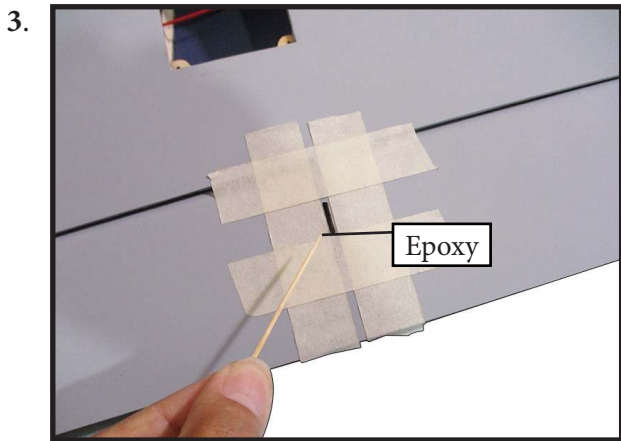
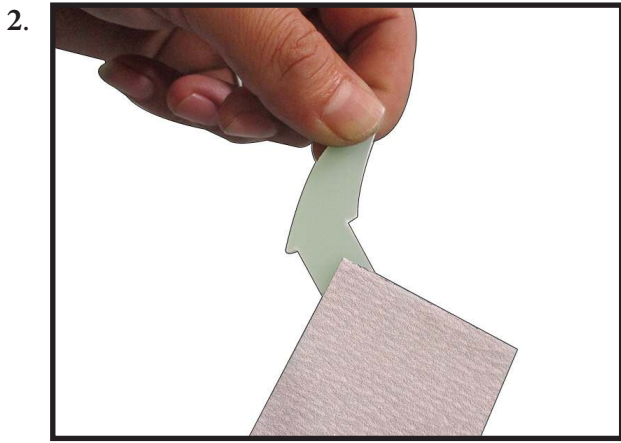

INSTALLING THE AILERON SERVOS

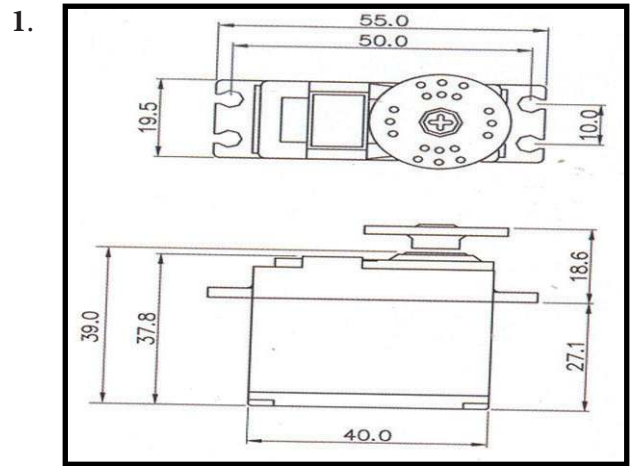

Recommended Servo Spec Torque.
 378 oz-in (27.3 kg-cm) @ 6.0V
 467 oz-in (33.7 kg-cm) @ 7.4V

 Because the size of servos differ, you may need to adjust the size of the precut opening in the mount. The notch in the sides of the mount allow the servo lead to pass through.

Place the servo between the mounting blocks and space it from the hatch. Use a pencil to mark the mounting hole locations on the blocks.

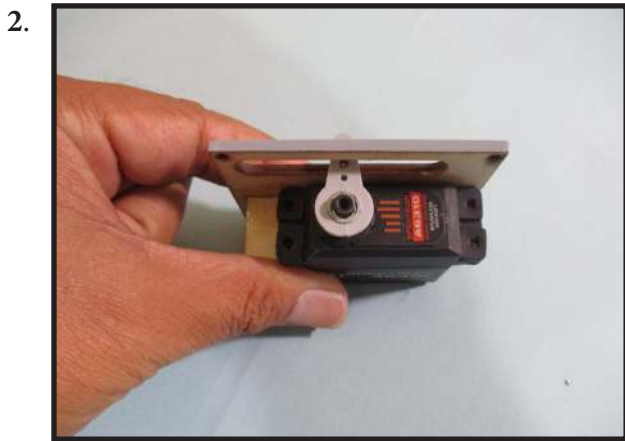

Use drill bit in a pin vise to drill the mounting holes in the blocks.

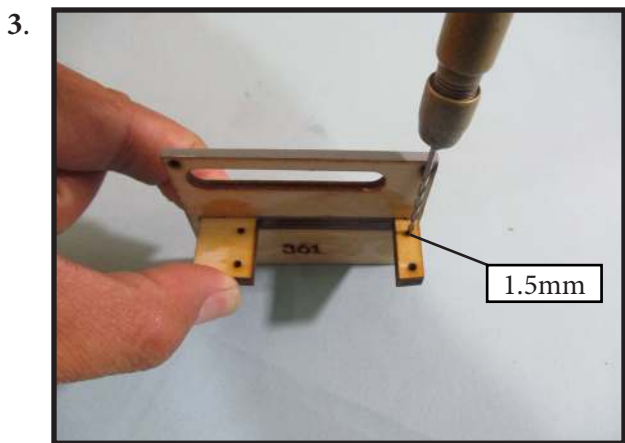

Apply 2-3 drops of thin C/A to each of the mounting holes. Allow the C/A to cure without using accelerator.

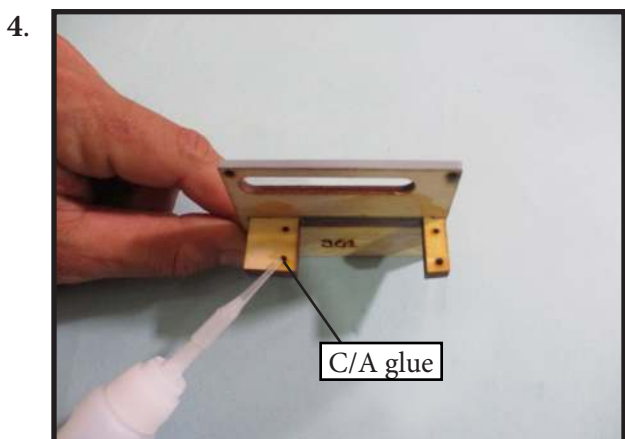

Use dental floss or heat shrink tubing to secure the connection between the servo and extension wire so they cannot become unplugged accidentally.

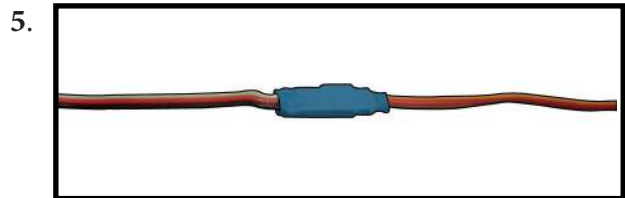

Secure the servo to the aileron hatch using a proper driver and the screws provided with the servo.

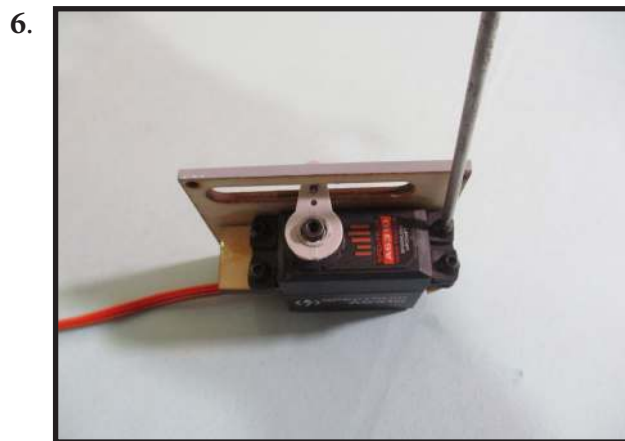

Apply 2-3 drops of thin C/A to each of the mounting aileron hatch mounting tabs in the wing. ***Allow the C/A to cure without using accelerator.***

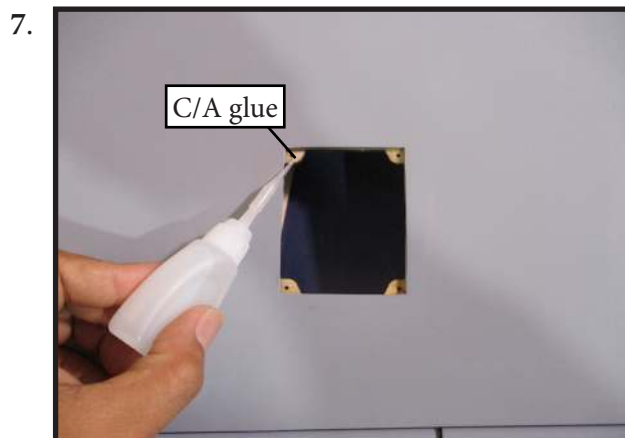

Remove the string from the wing at the servo location and use the tape to attach it to the servo extension lead. Pull the lead through the wing and remove the string.

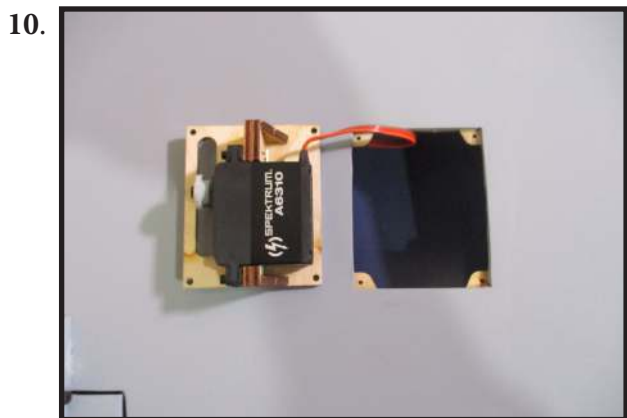
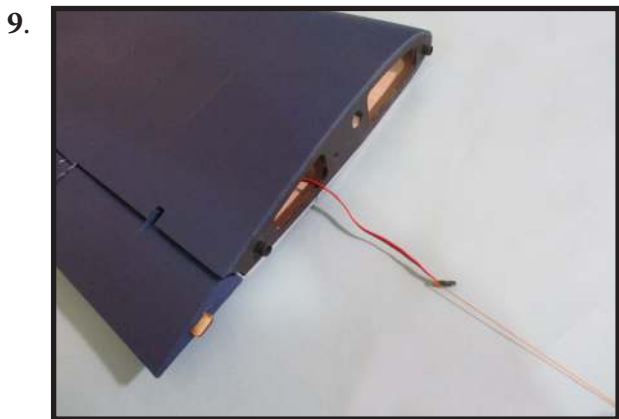
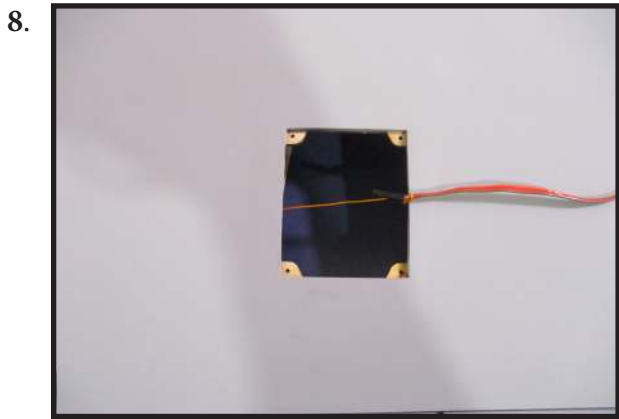

Set the aileron hatch in place and use a Phillips screw driver to install it with four wood screws.

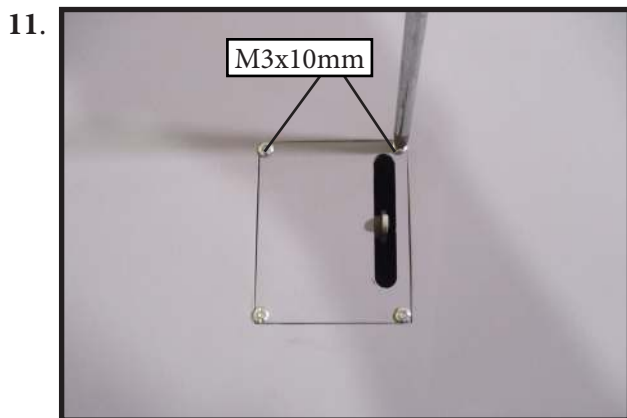

AILERON PUSHROD INSTALLATION

Please see pictures below.

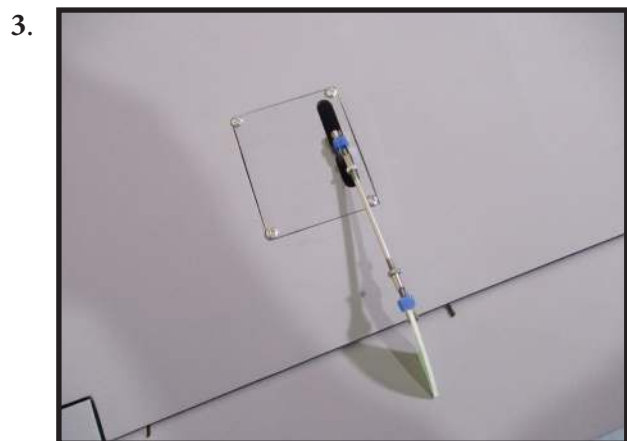
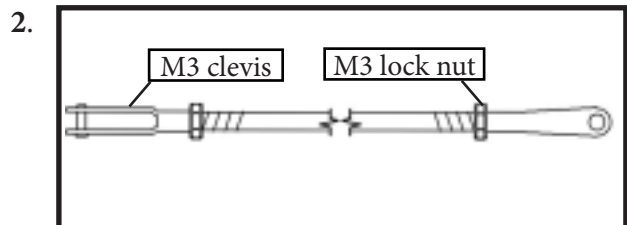
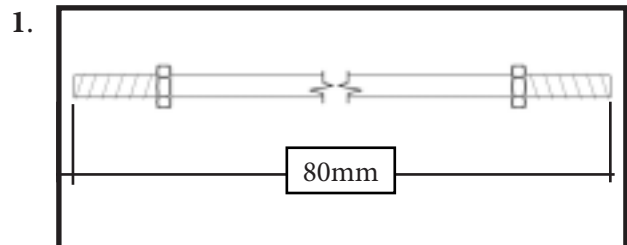

INSTALLING THE FLAP PUSHROD

Please see pictures below.

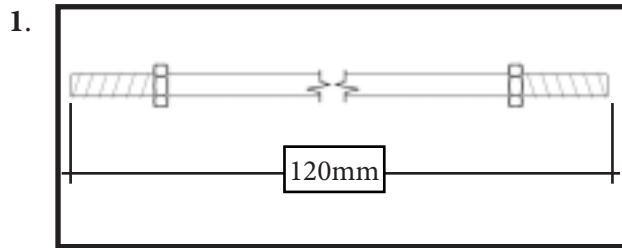

Attach the flap servo to the flap servo cover. Center the flap servo (or set the values to 0 for both up and down) and install the servo arm perpendicular to the servo centerline. The clevis will attach to the arm 13/16 inches (21mm) from the center of the arm.

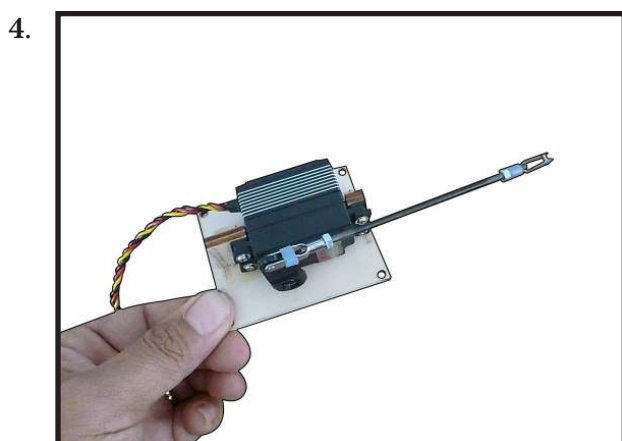
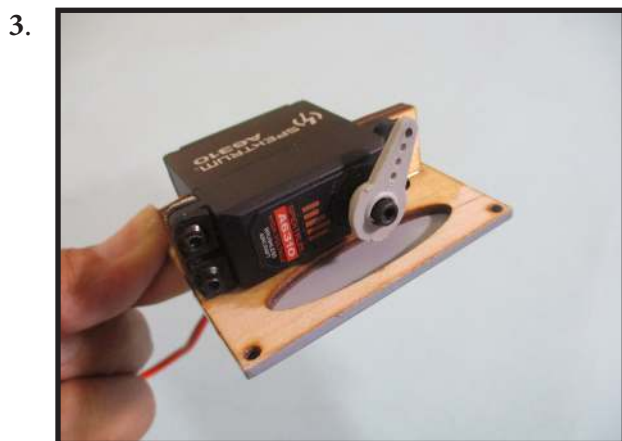

Attach the flap linkage to the control horn. Slide the clevis retainer over the forks of the clevis.



Attach the clevis to the flap servo arm.

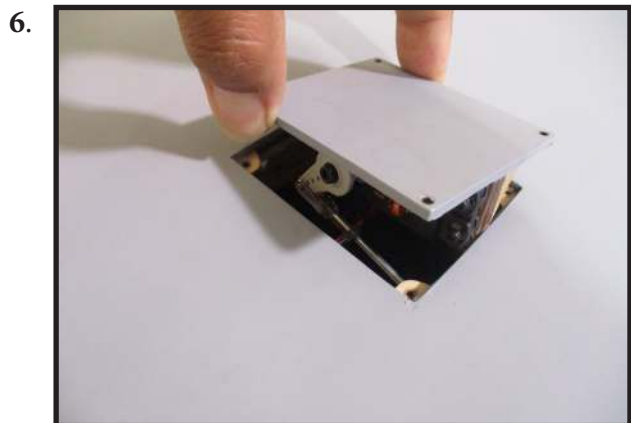

Use a pin vise and 3/32-inch (2mm) drill bit to clear the paint from the flap control horn.



Route the servo lead for the flap servo out at the root of the wing. Connect the flap servo to the radio system. With the radio system on, place the flap servo into position.

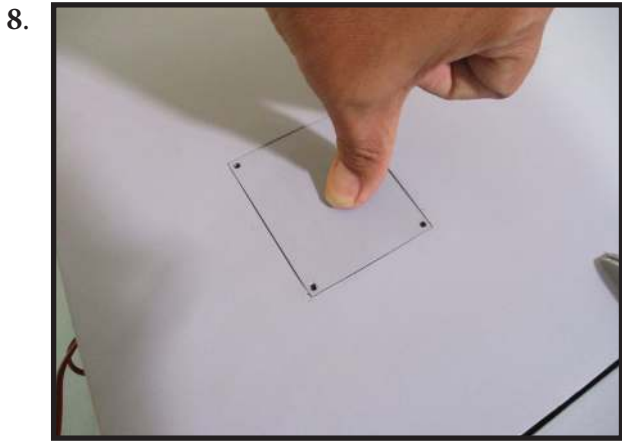

Adjust the linkage so the flap is in the mid-flap position. It may take a few tries to properly adjust the linkage.

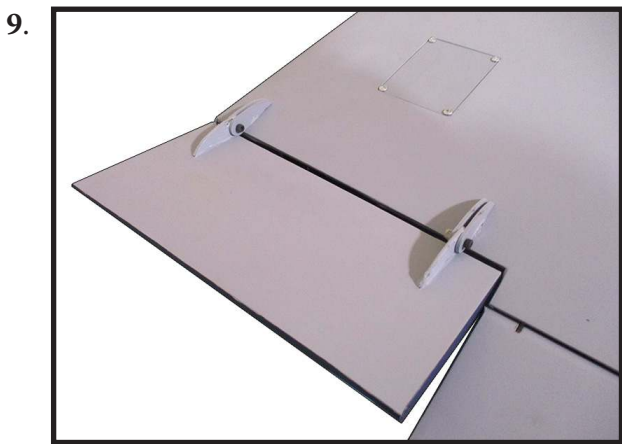

Once adjusted, make sure all clevis retainers are in position. Apply a drop of threadlock near the clevis, then tighten the nut against the clevis to keep the linkage from changing length inside the wing.

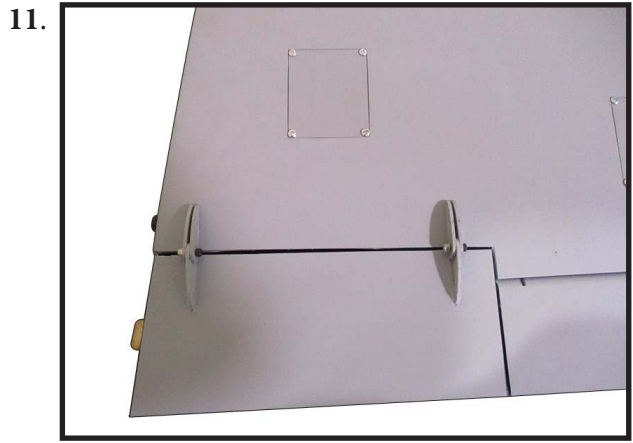
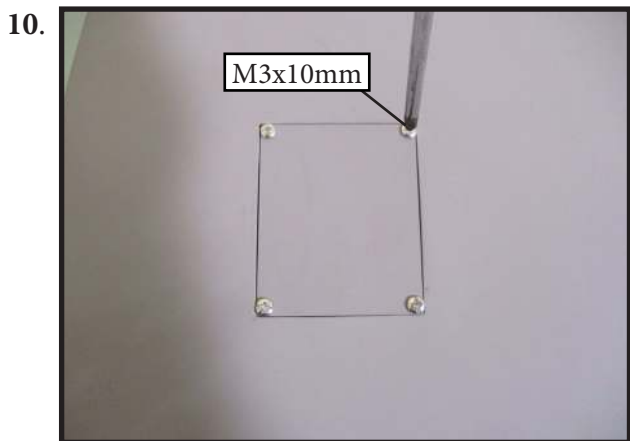

Set the flap control at the transmitter to the down flap position. Adjust the flap travel at the transmitter until it matches the control throws listed in this manual.

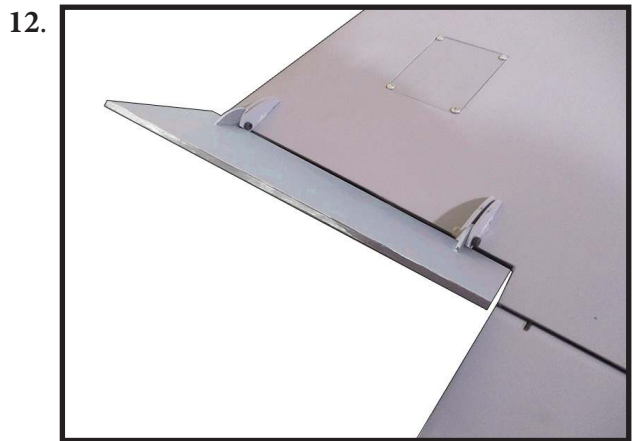

INSTALL FLAP BETWEEN WINGS

Please study images below.

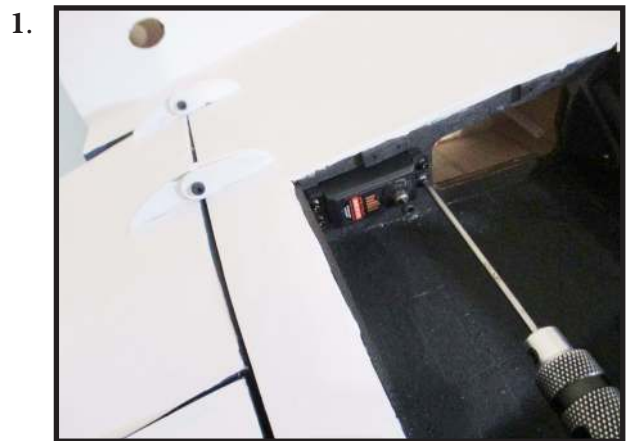

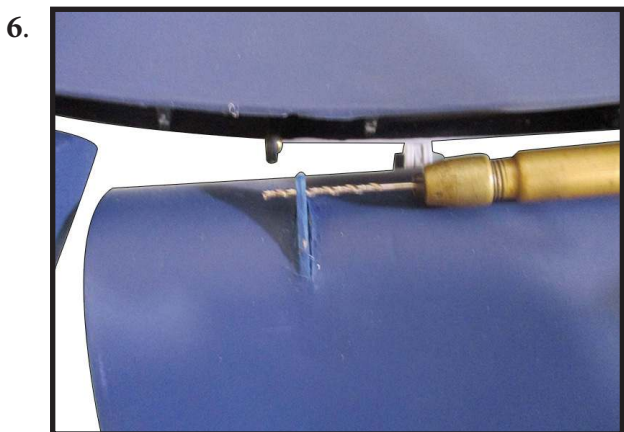
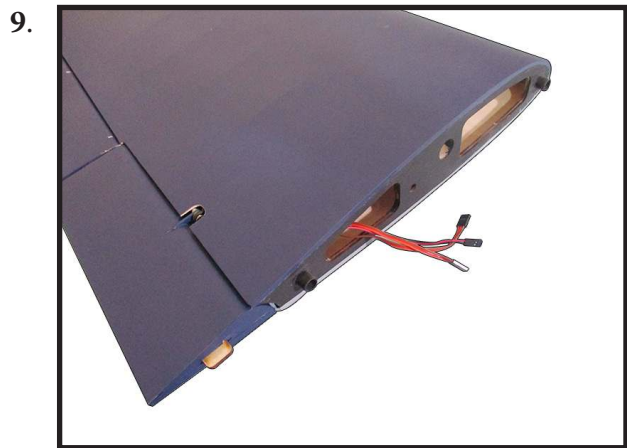
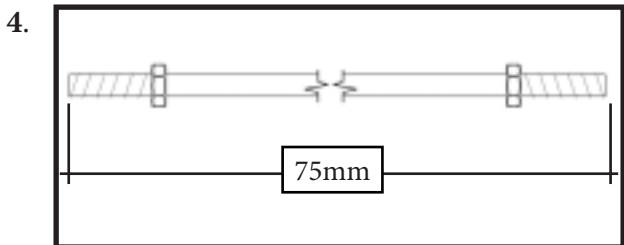
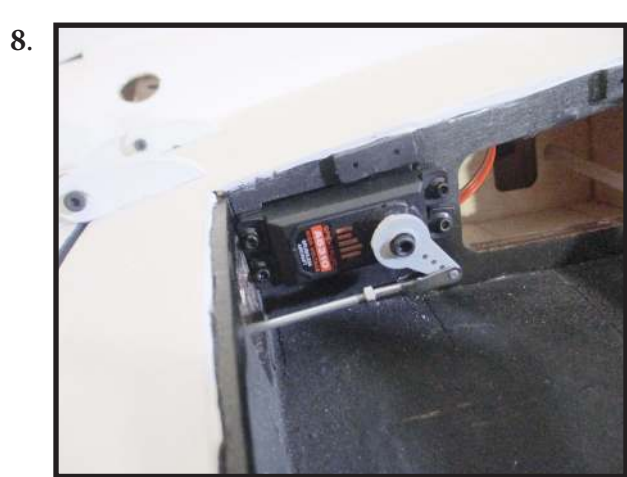
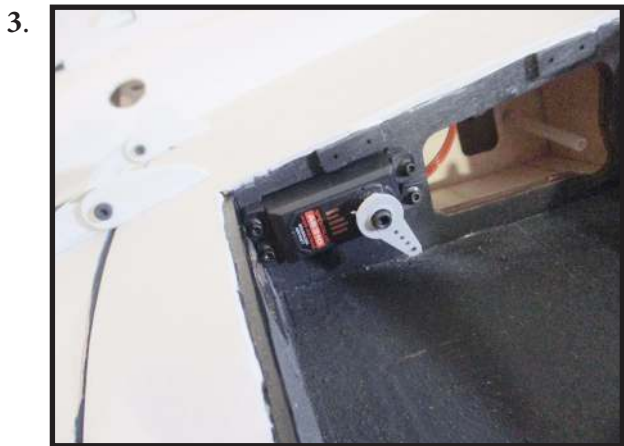
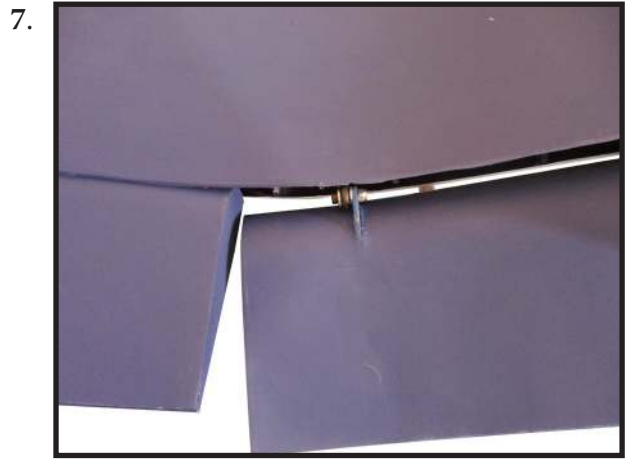

Install the gear door, please see the picture below.

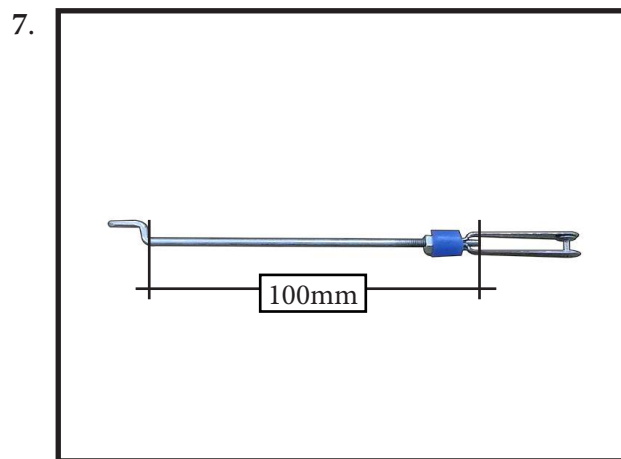
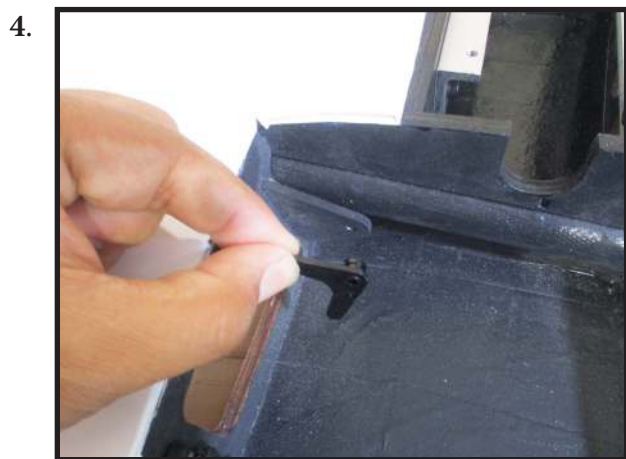
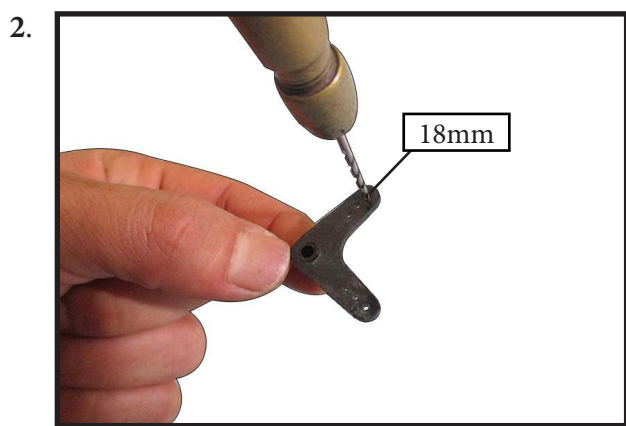
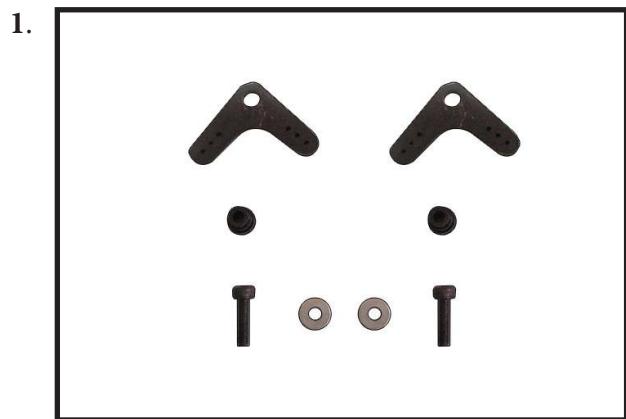

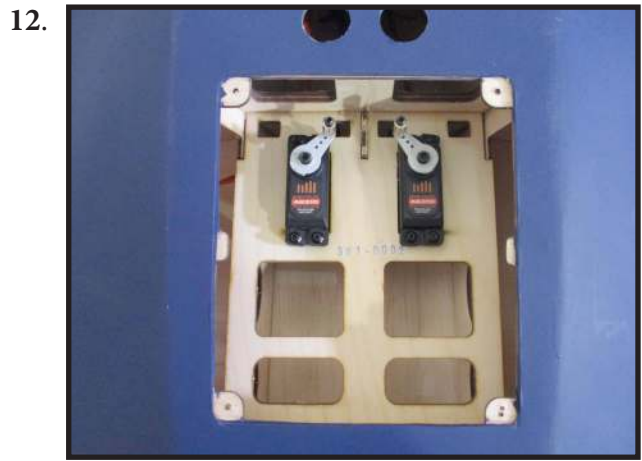

Install the gear door servo into the wing cover as shown below in these illustrated steps.

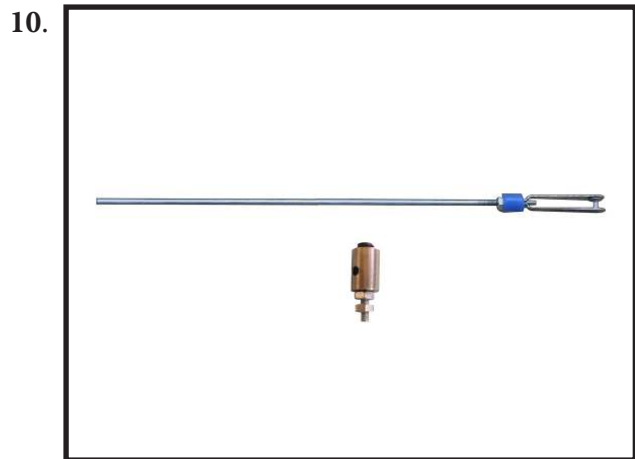

INSTALLING ROBART LANDING GEAR

Retractable landing gear are not included. Please study images below for proper installation. You may install electric or pneumatic gear. Fuselage has accommodations for both.

Robart 150E MAIN GEAR 150ESP

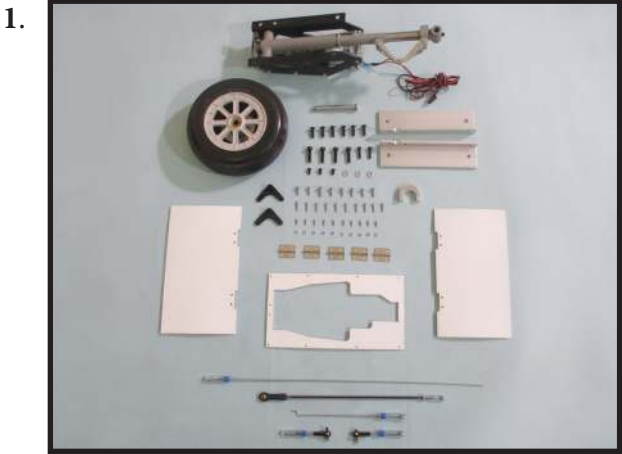

Install aluminum pedestal, please see the picture below.

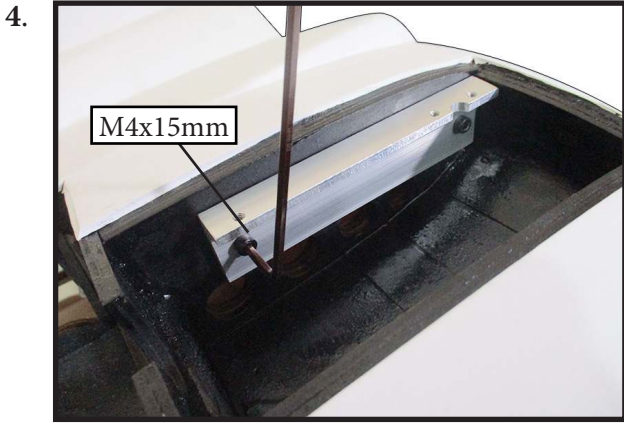
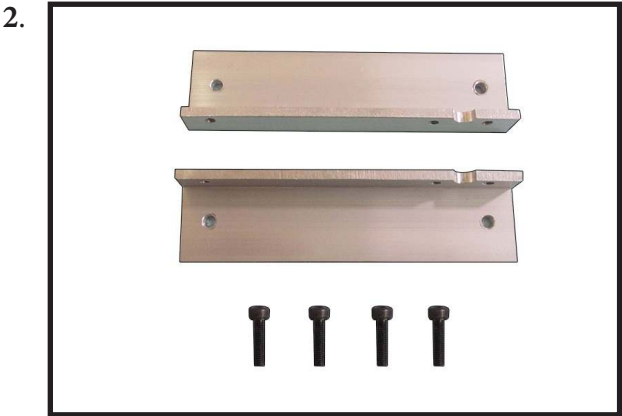

Install Main Retractable Landing Gear.

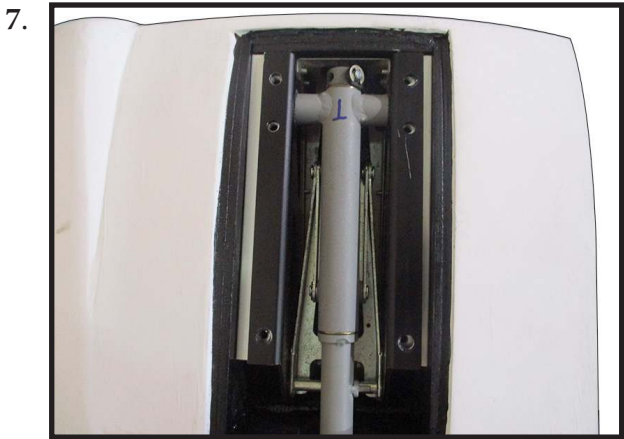
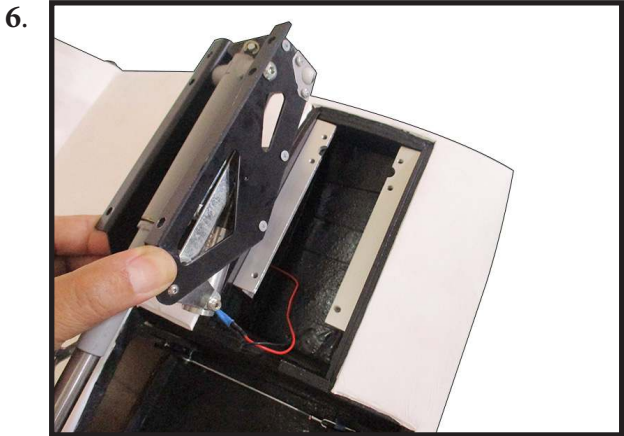

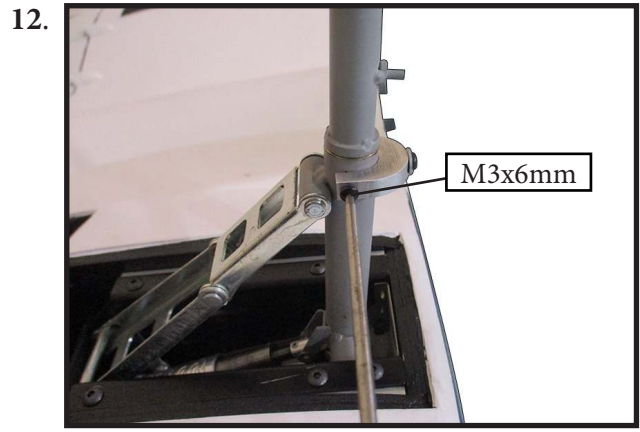
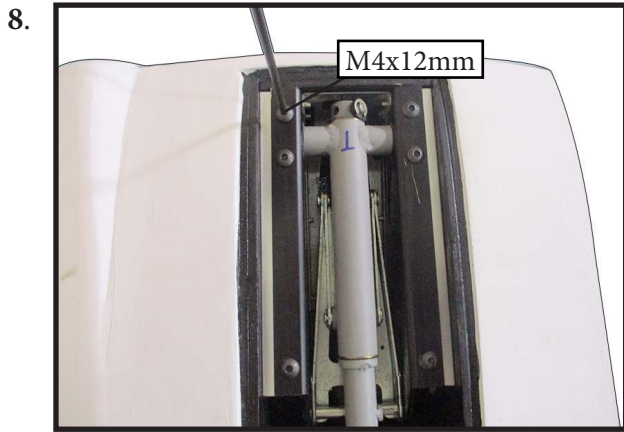

Install aluminum pieces into the landing gear struts as shown below.

Install the fork cover.

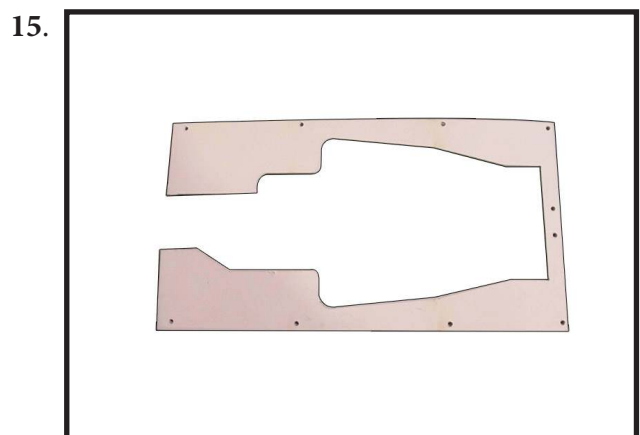
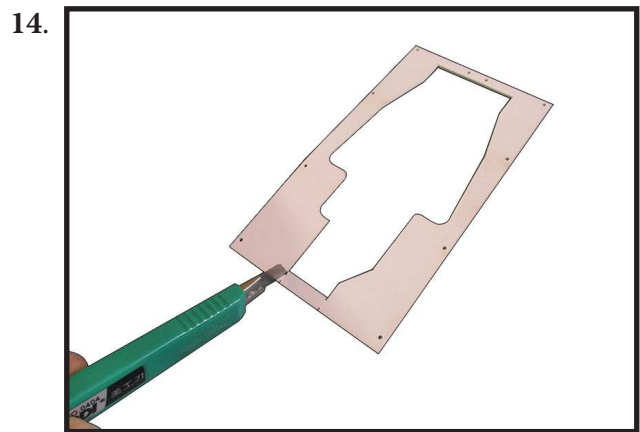
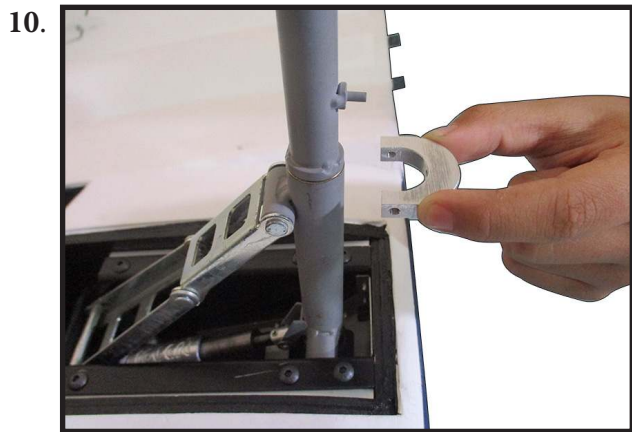

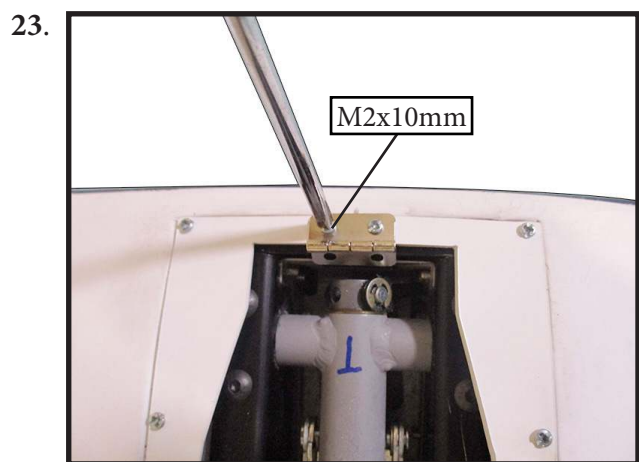
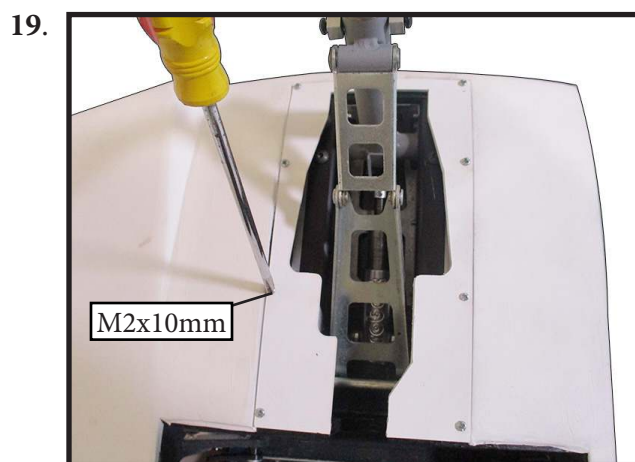
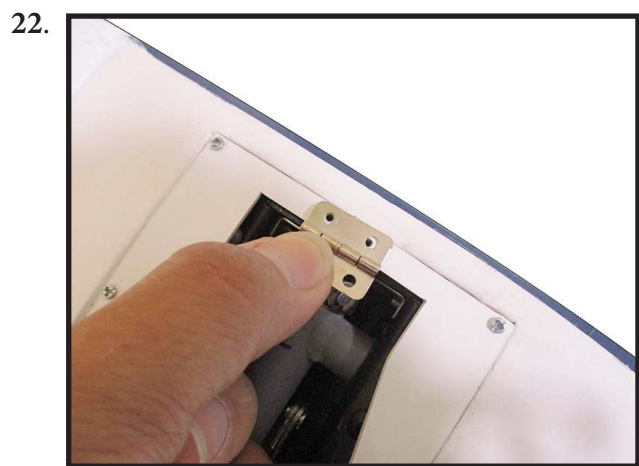
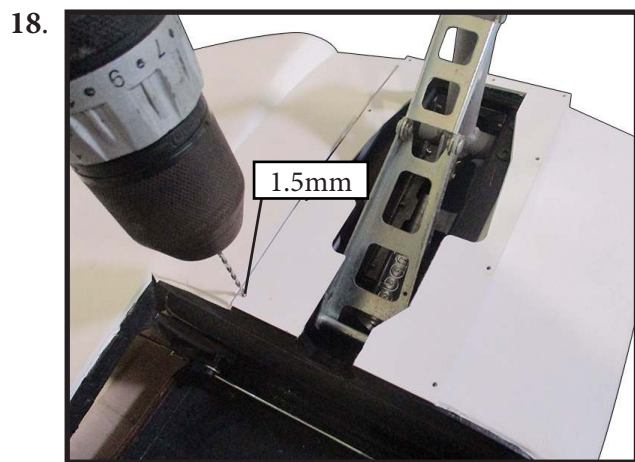
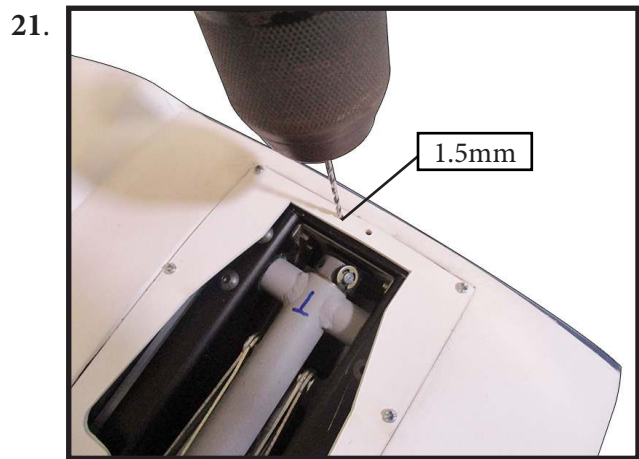
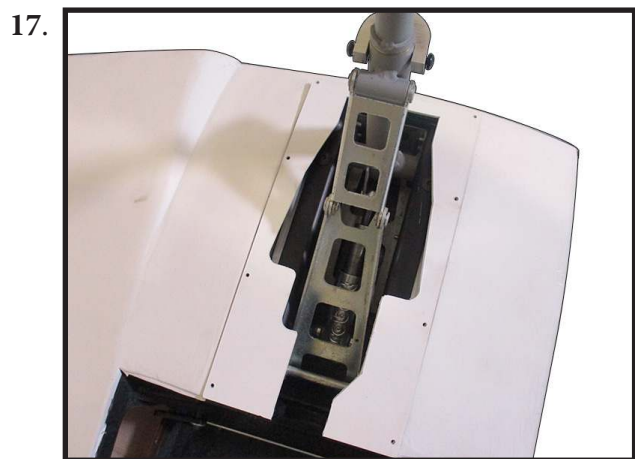
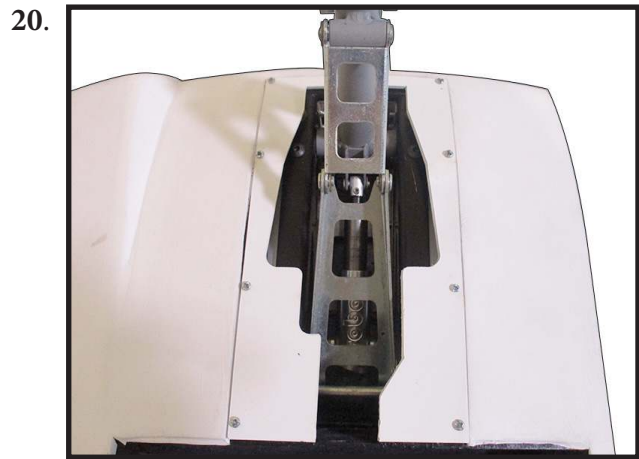
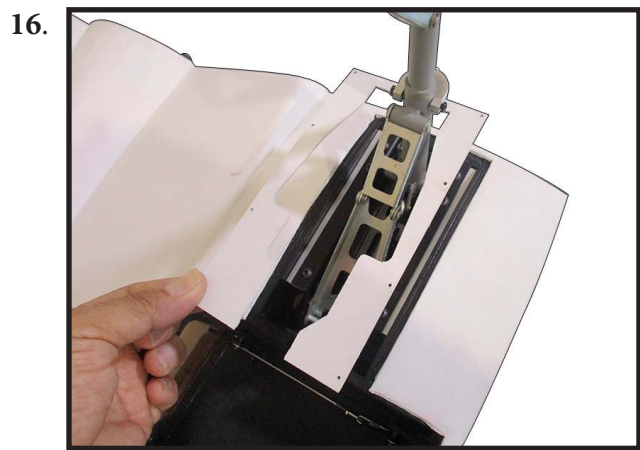

24.

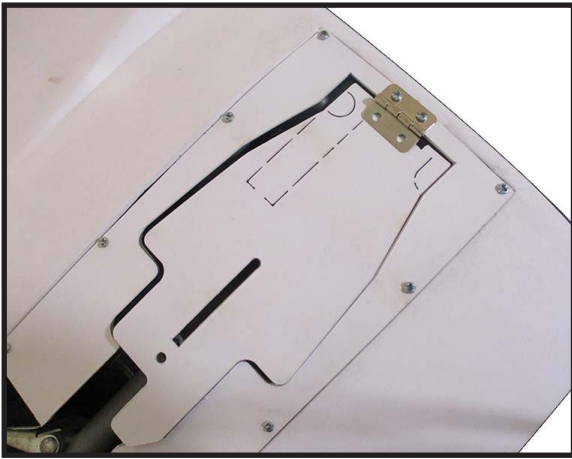

28.

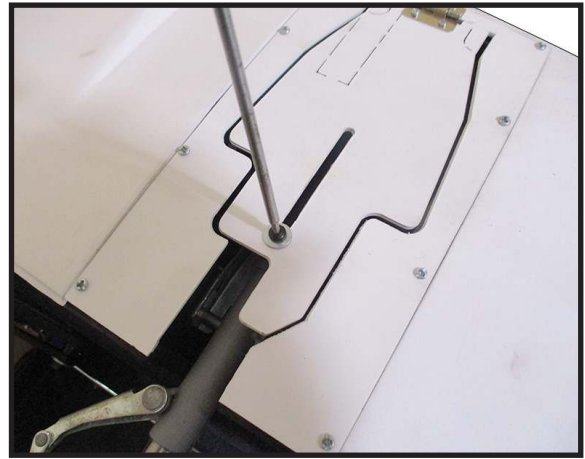

25.

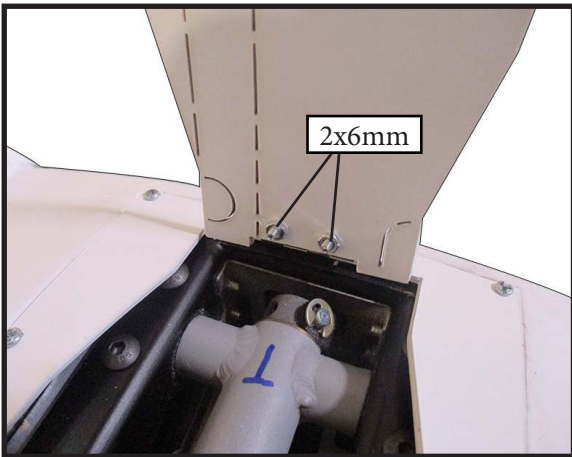

2x6mm

29.

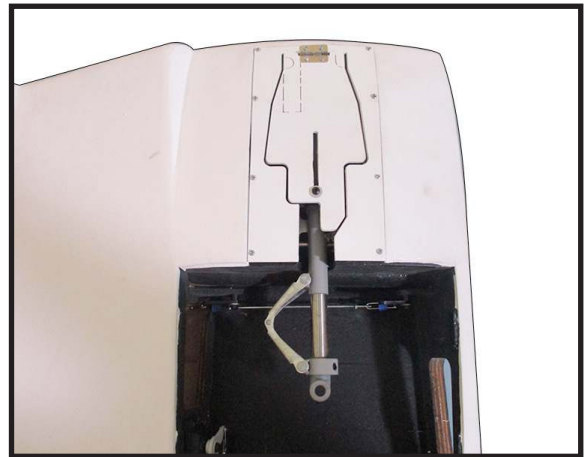

26.

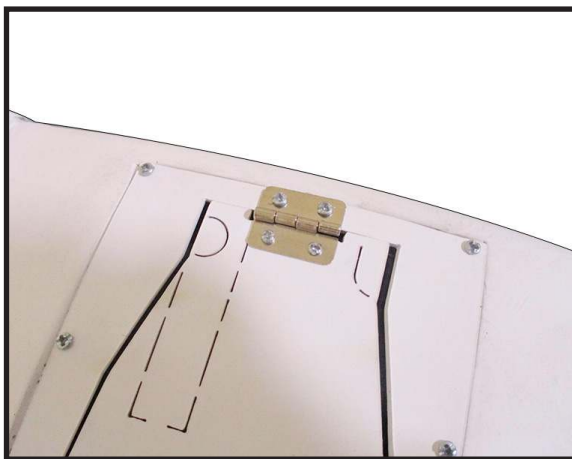

30.

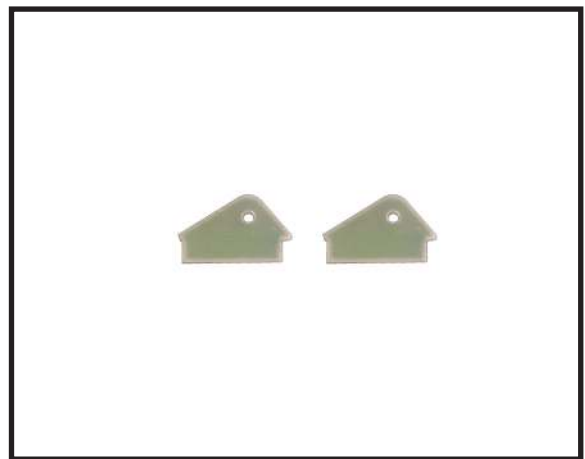

27.

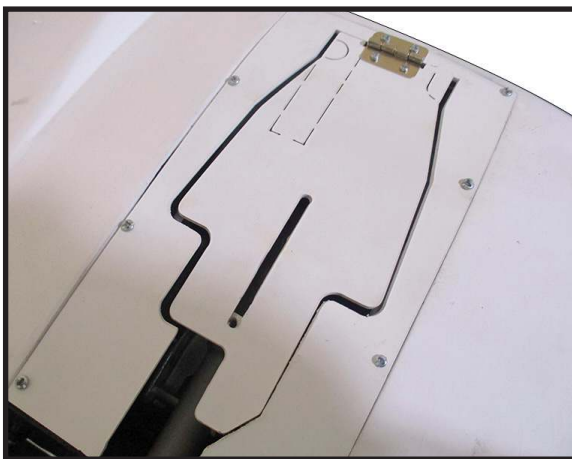

31.

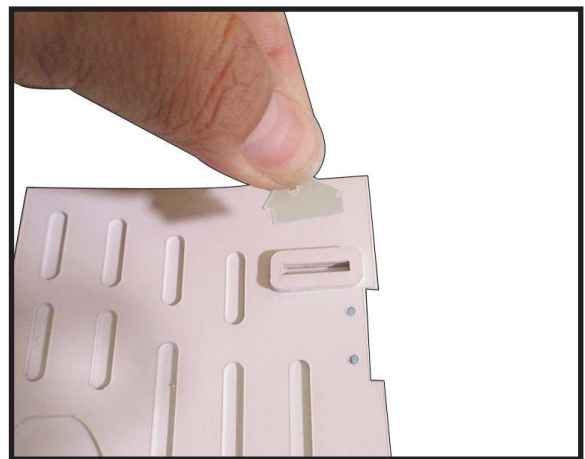

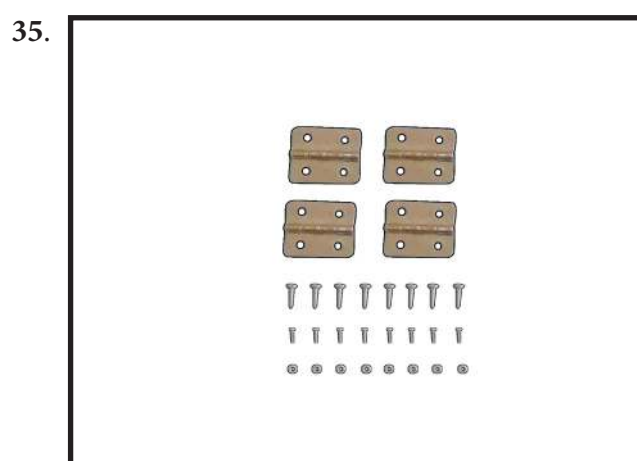
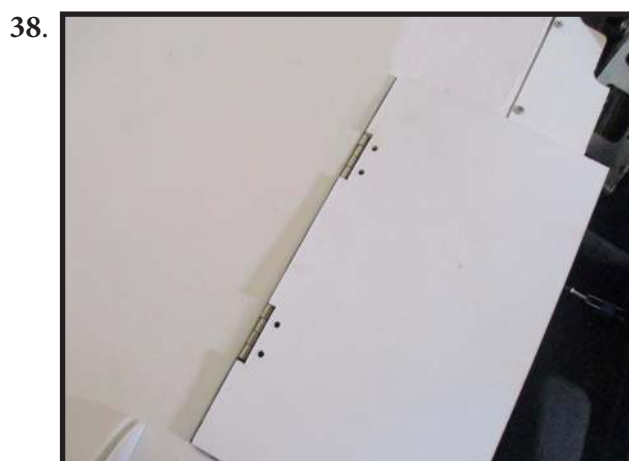
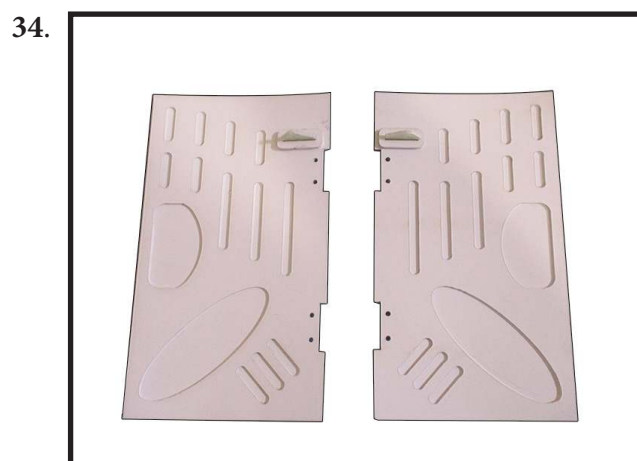
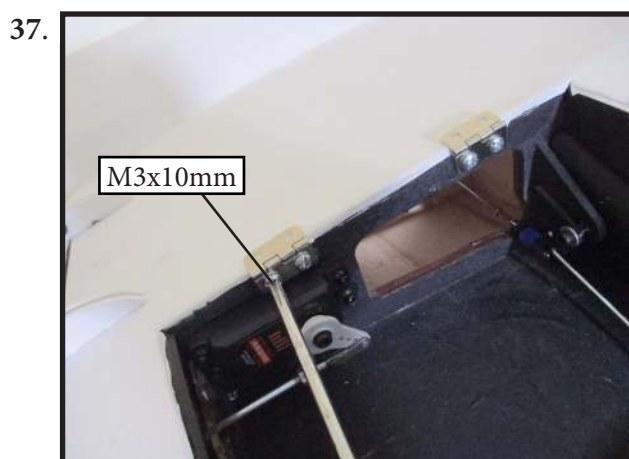
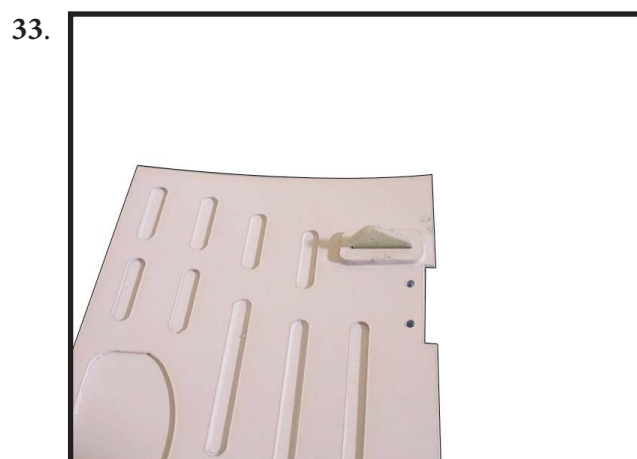
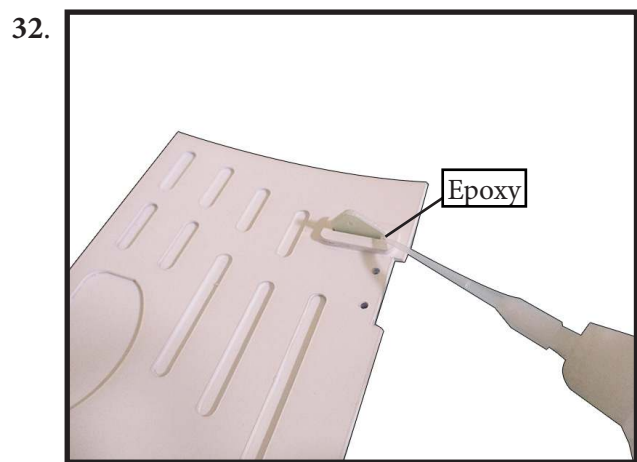

40.



44.

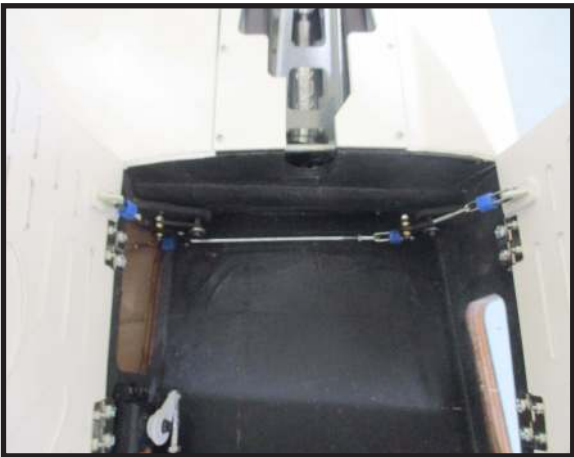

41.



Main Wheel installation.

45.



42.



46.



43.

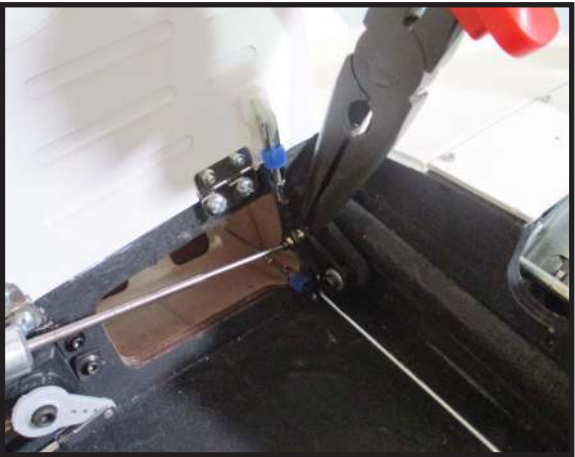

47.



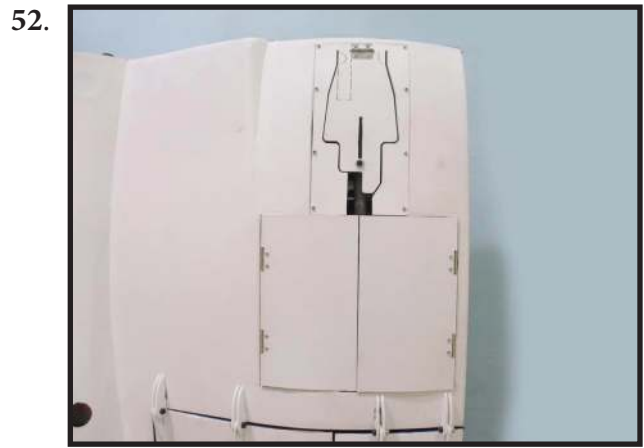
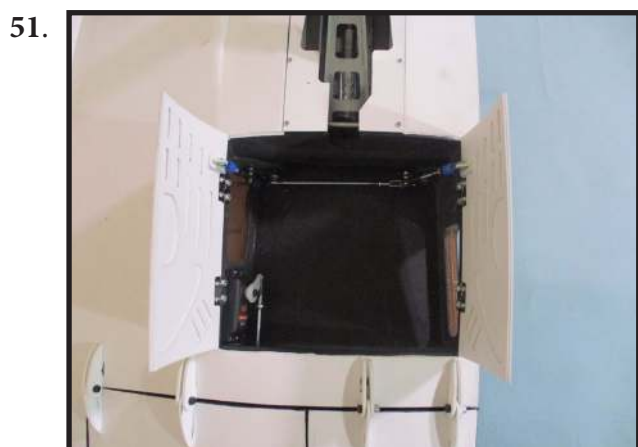
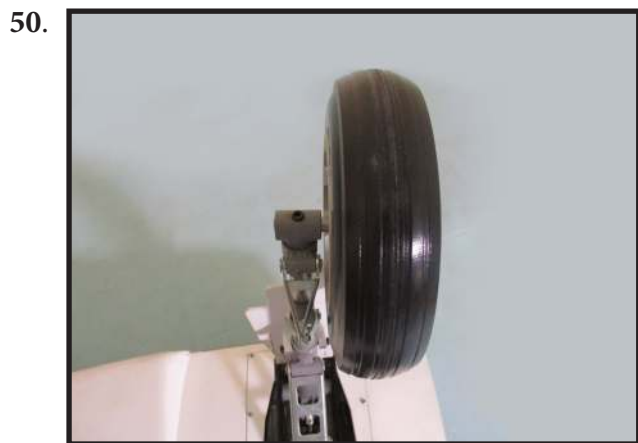
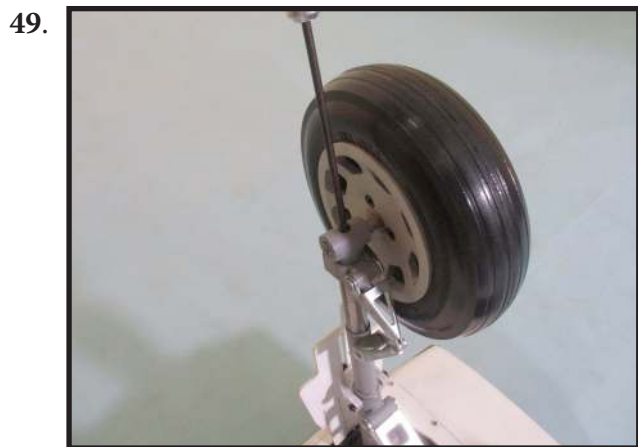
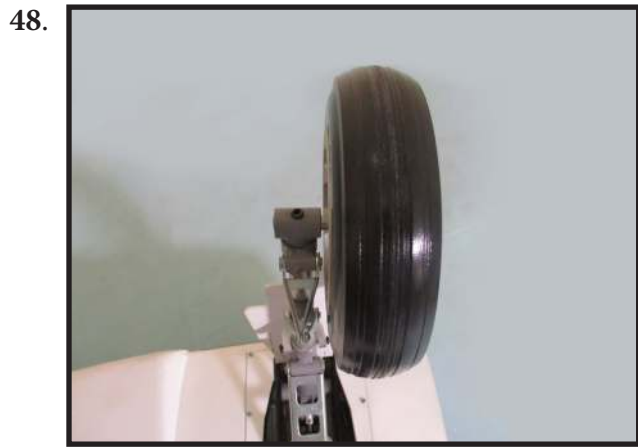

INSTALLING RETRACTABLE LANDING GEAR

- Locate items necessary to install Sprin Landing Gear.

You use this fork set JP ER-150 100° Retracts Rotating 90°

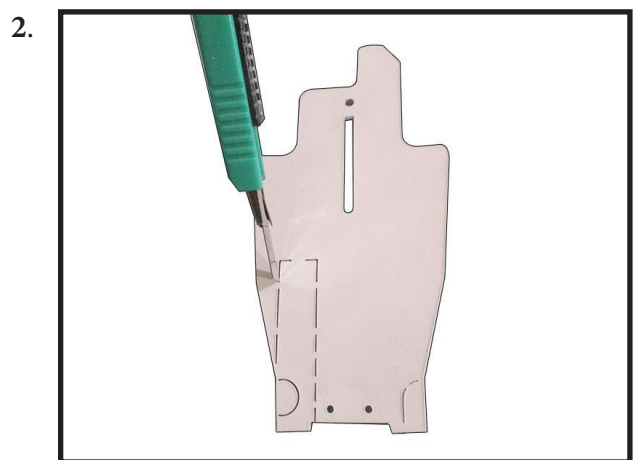
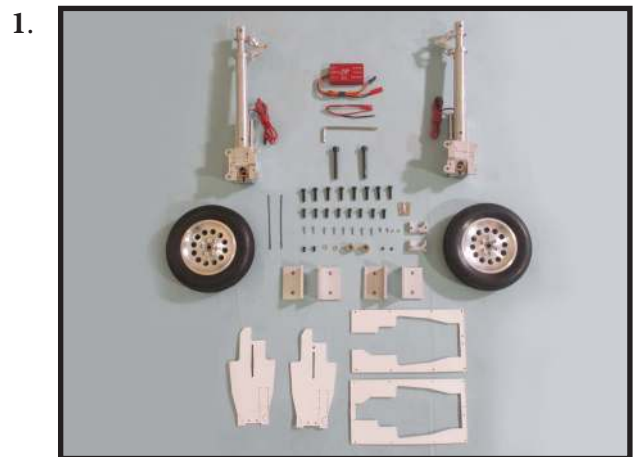

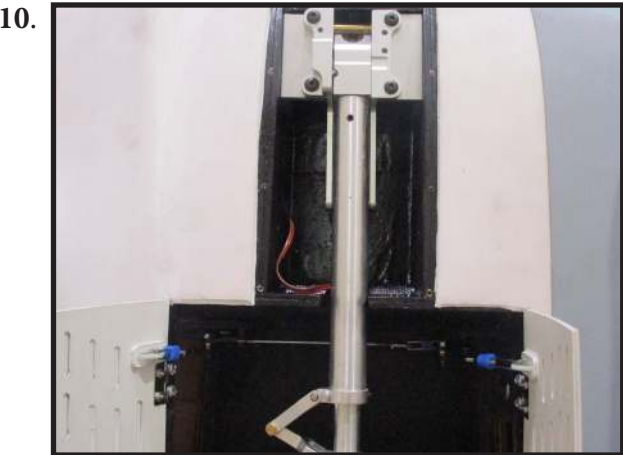
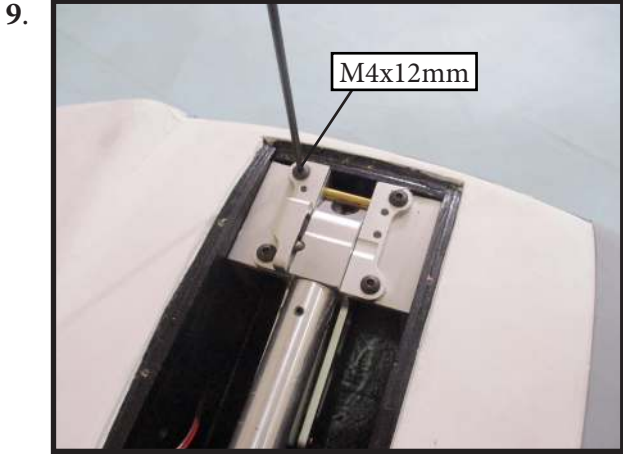
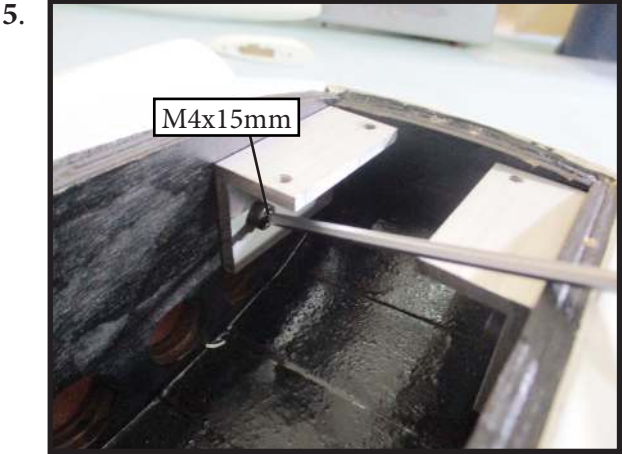
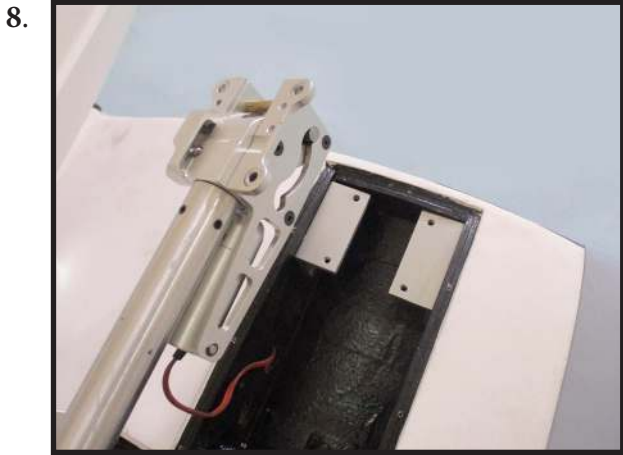
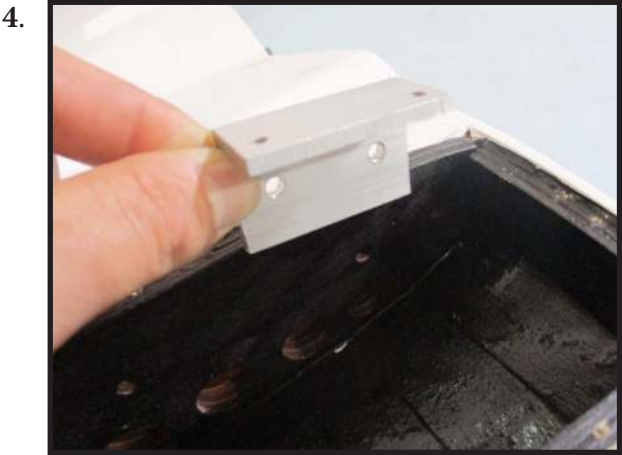
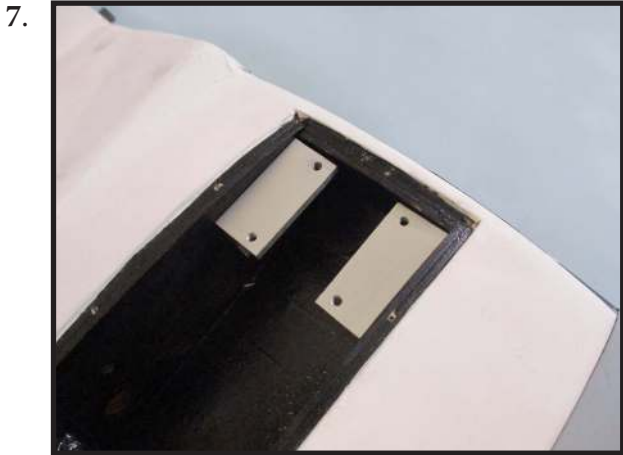
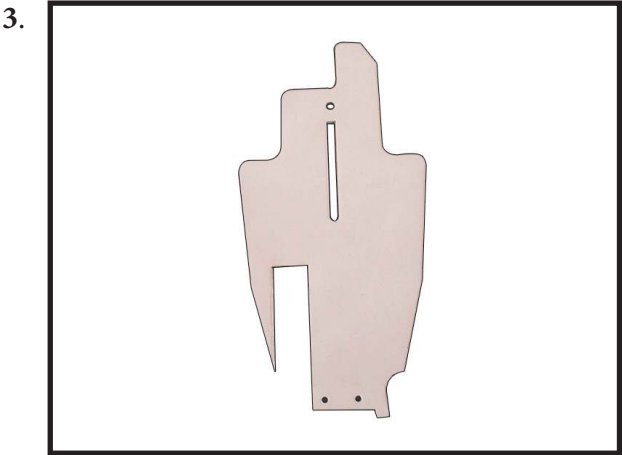

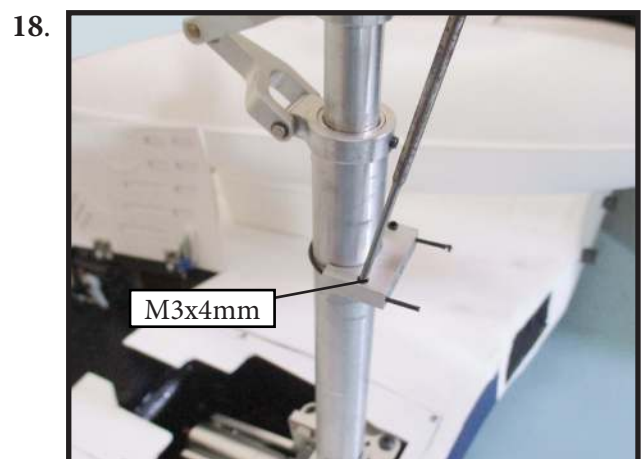
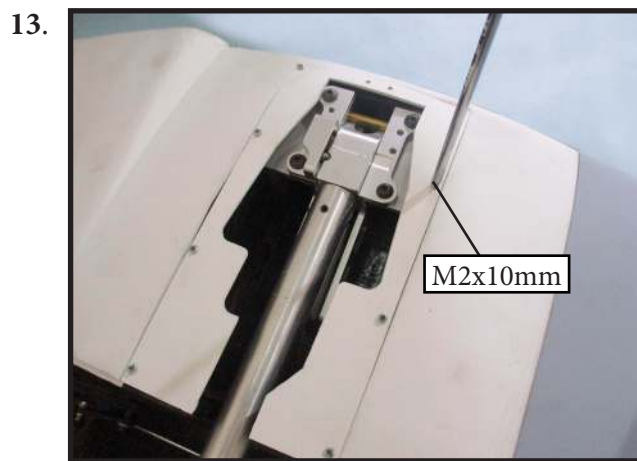
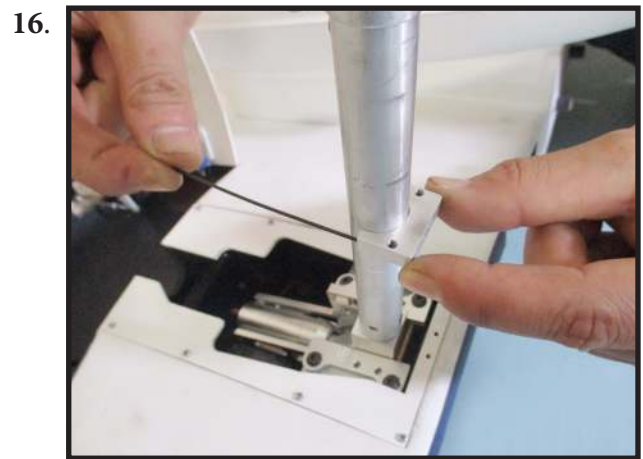
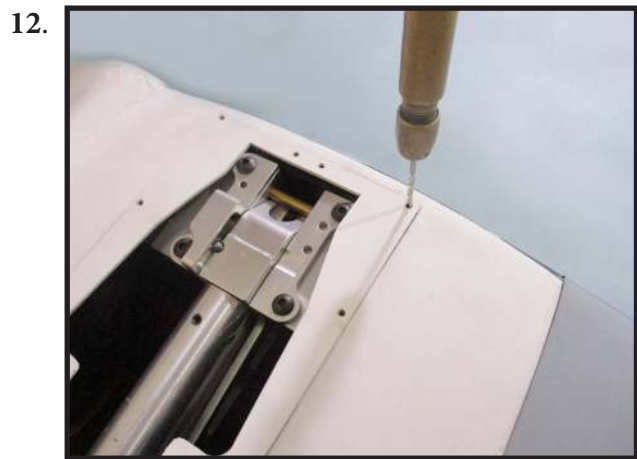
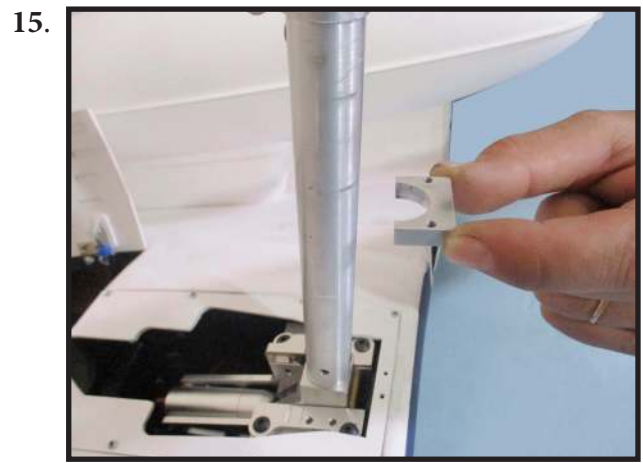
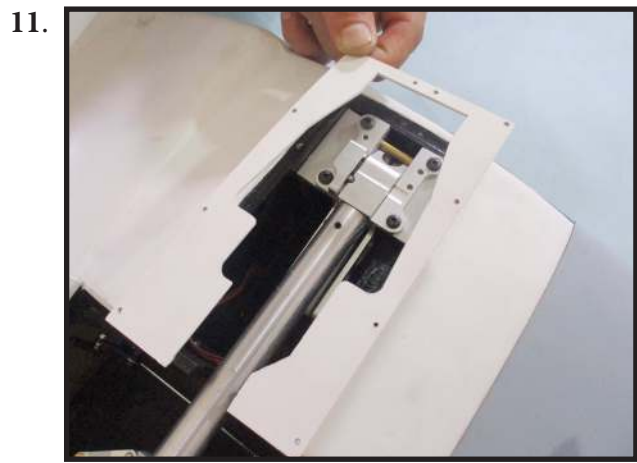

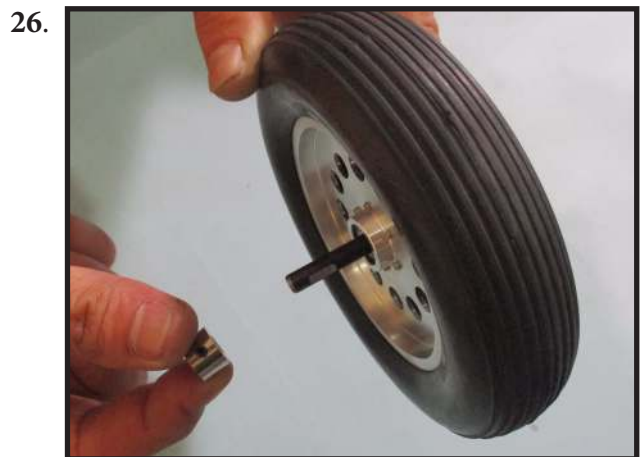
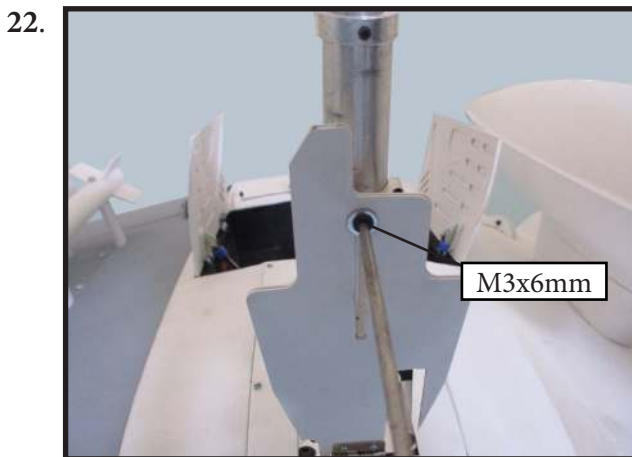
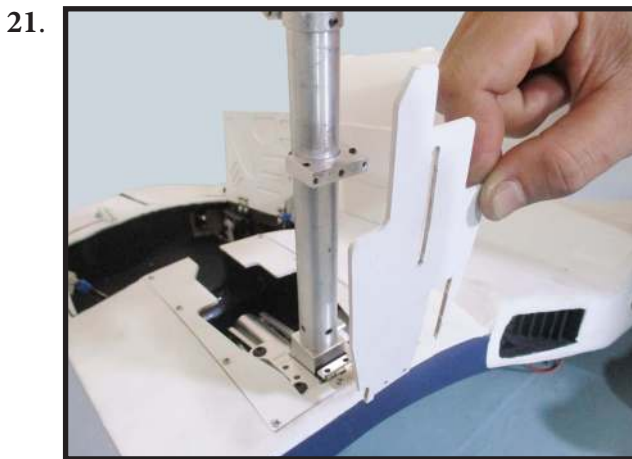
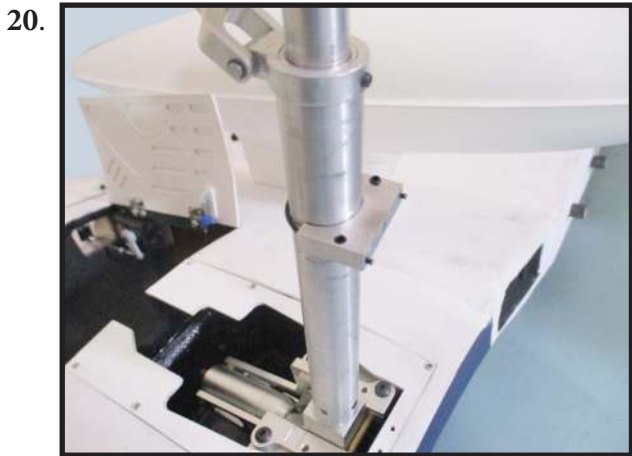
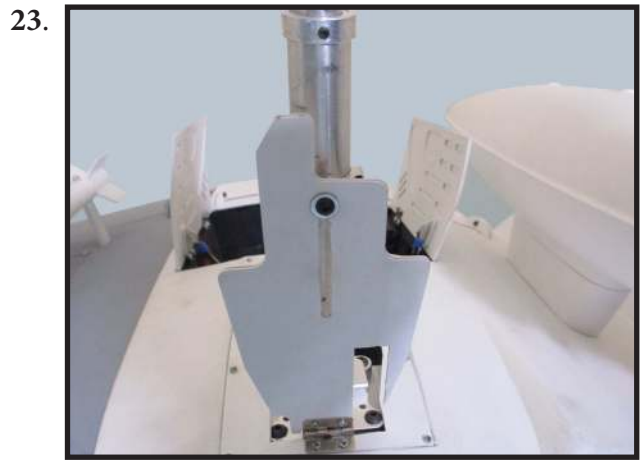
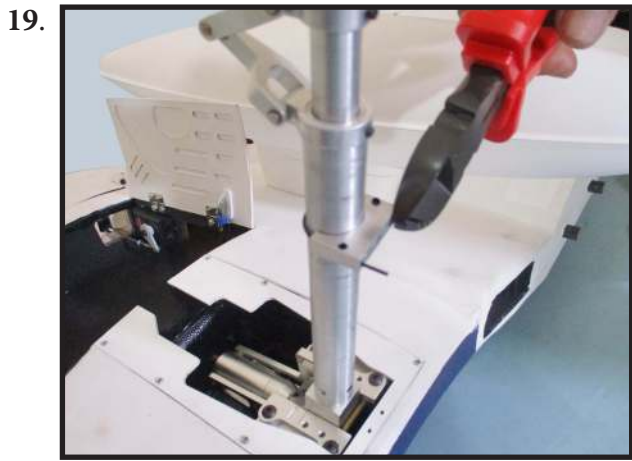

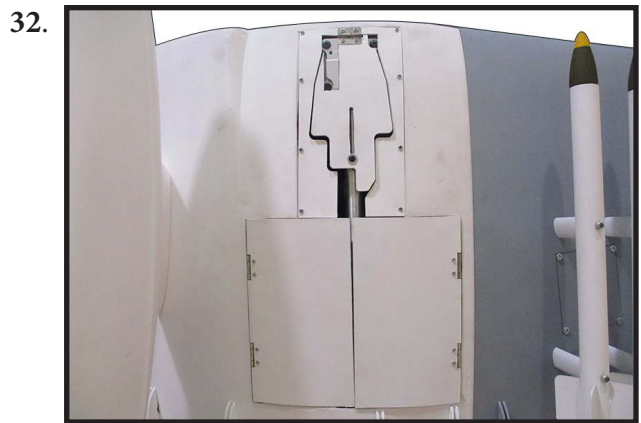
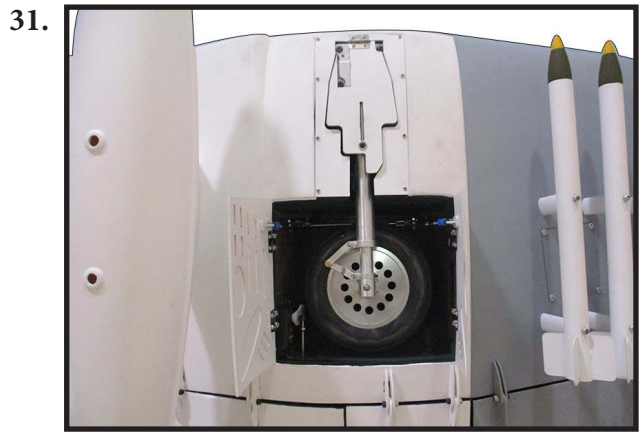
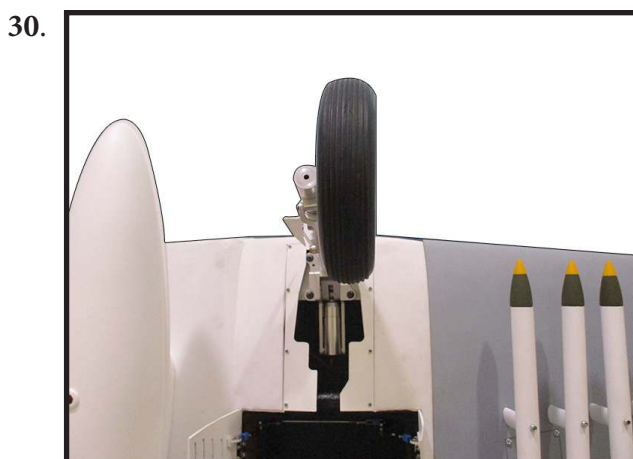
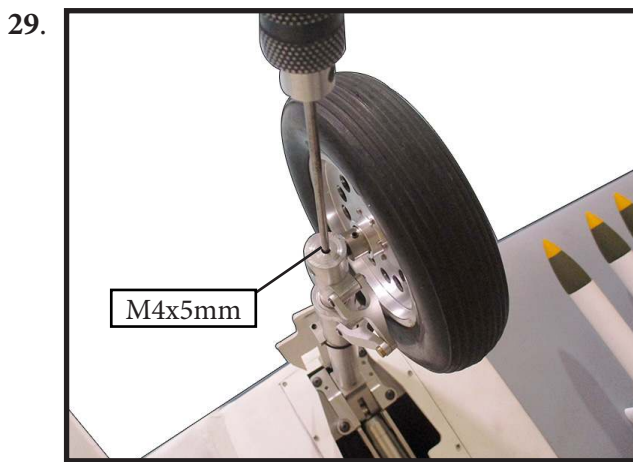
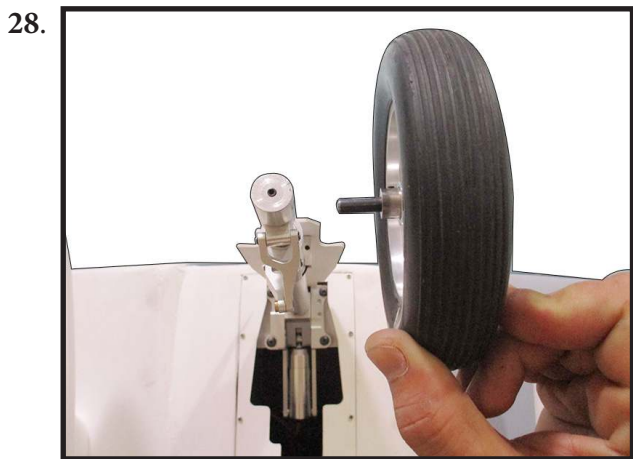
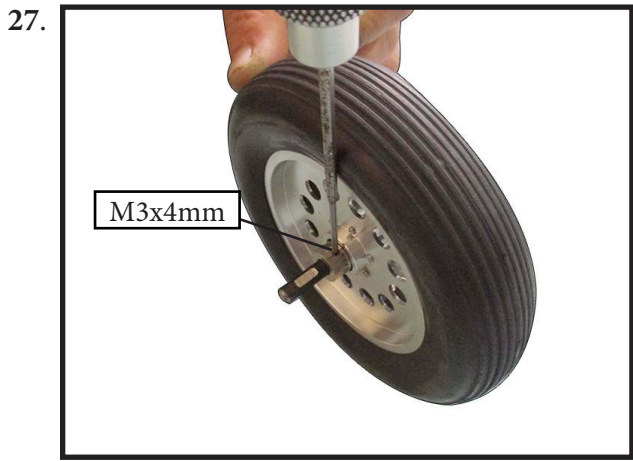

ROCKETS INSTALLATION

Please study images below.

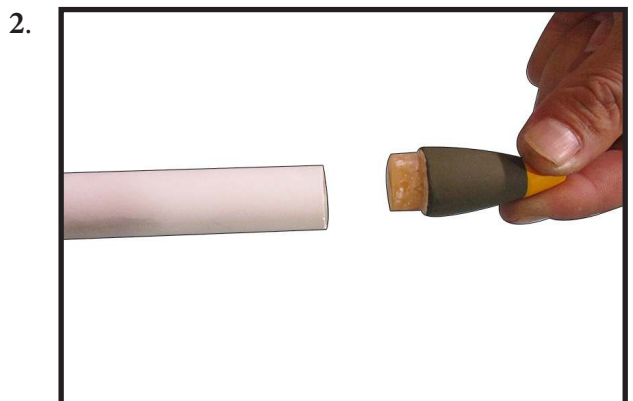

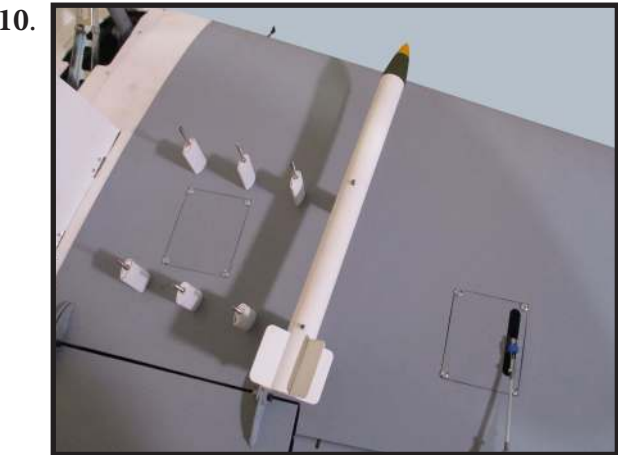
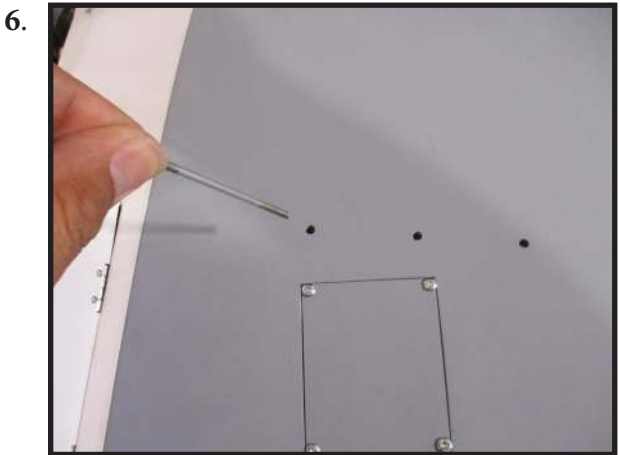
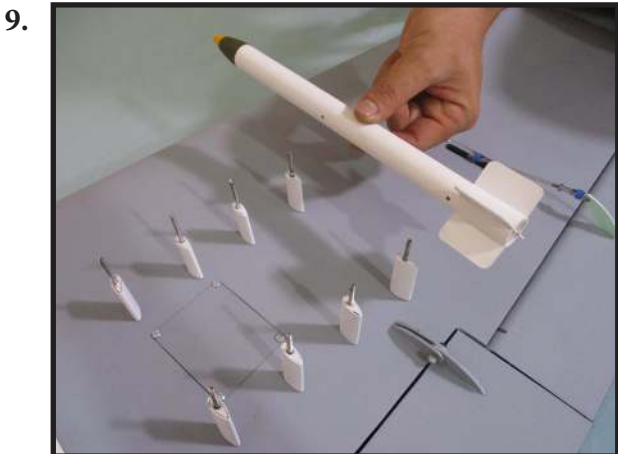
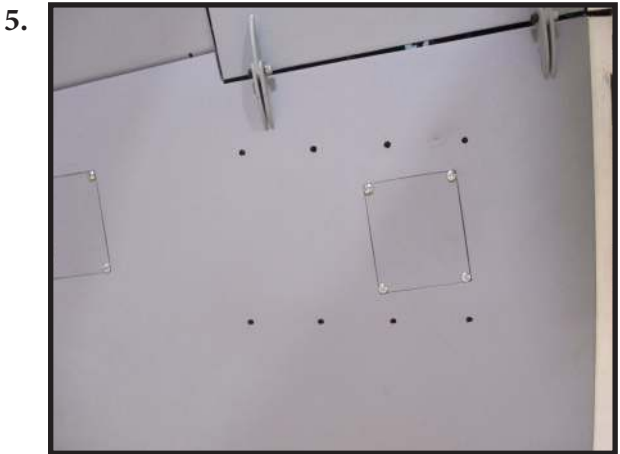
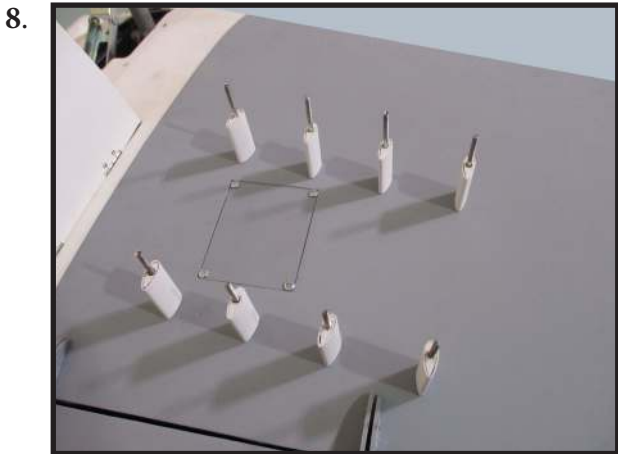
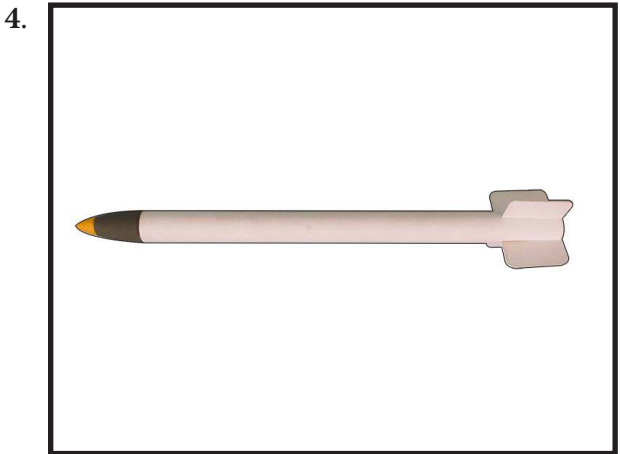
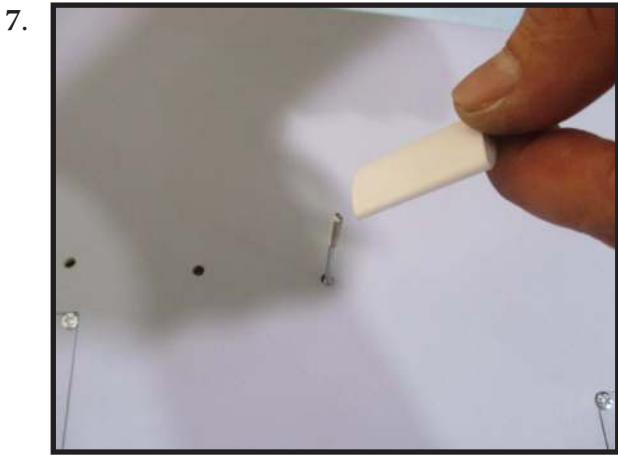
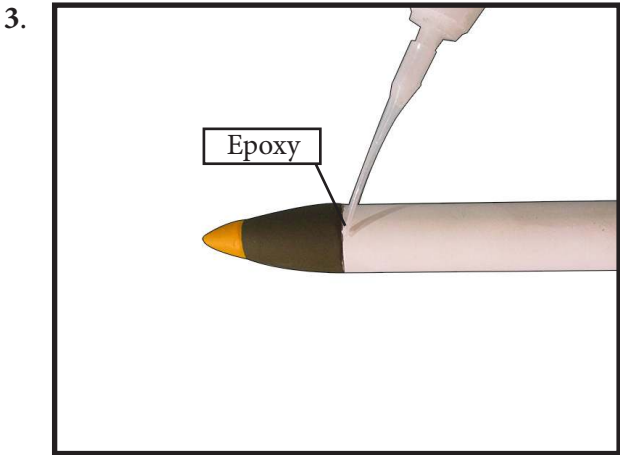

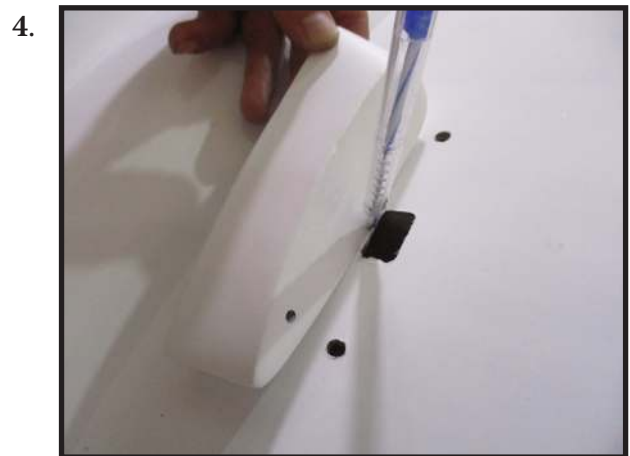
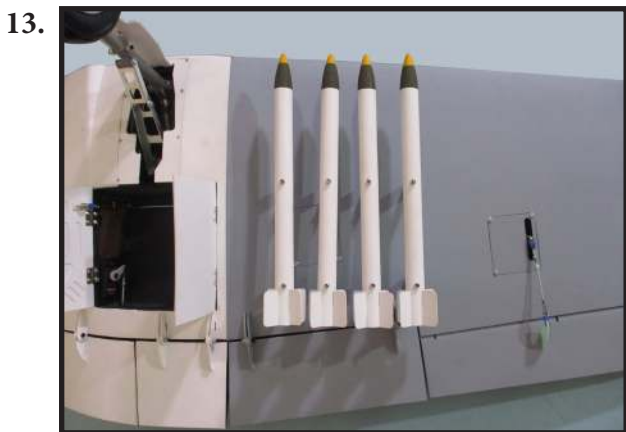
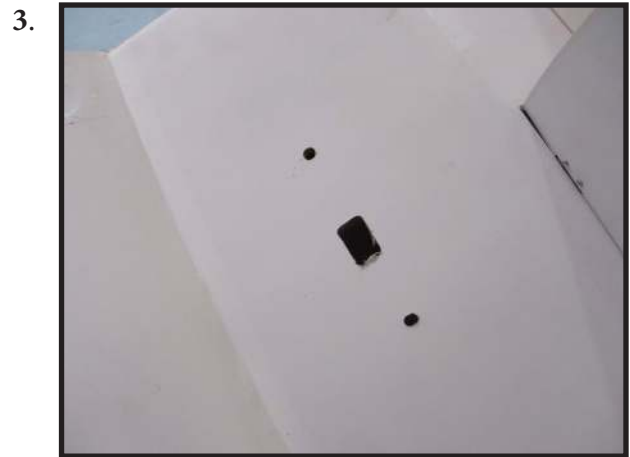
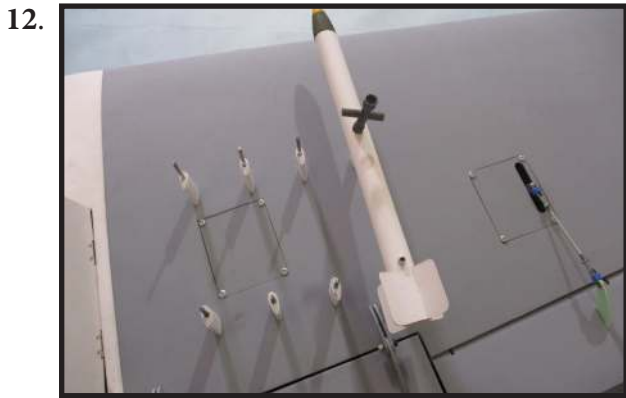
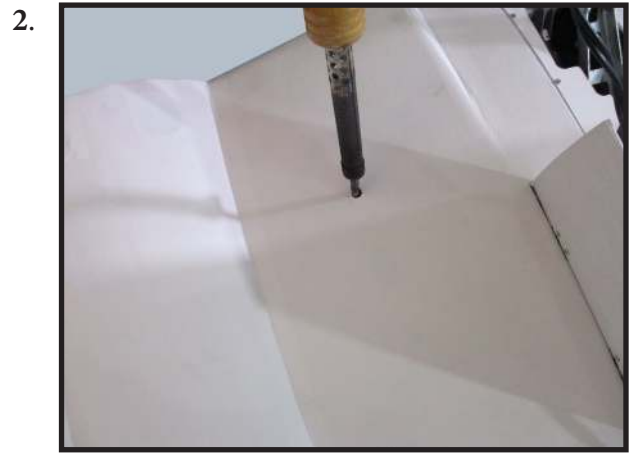
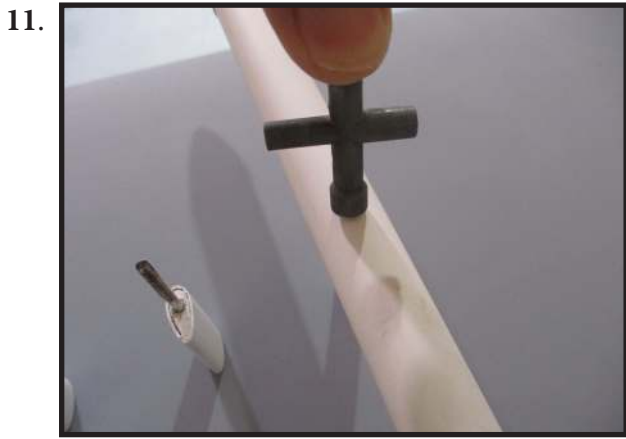

DROP TANK/BOMB INSTALLATION

Please study images below.



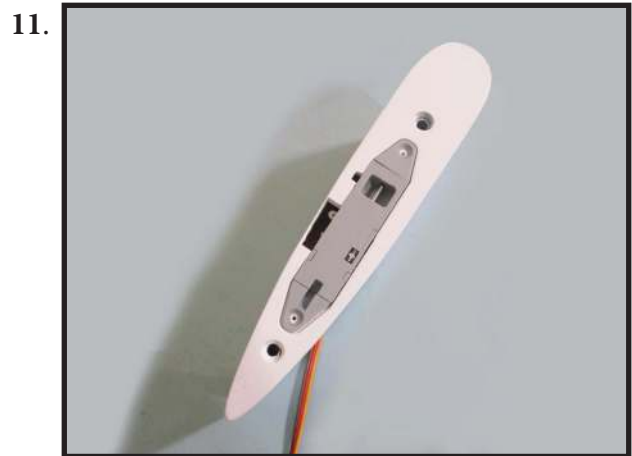
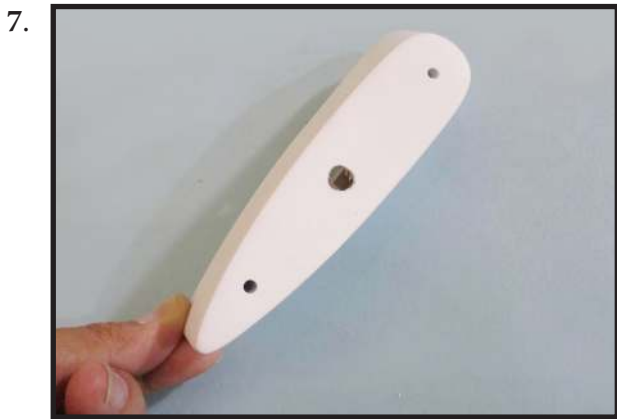
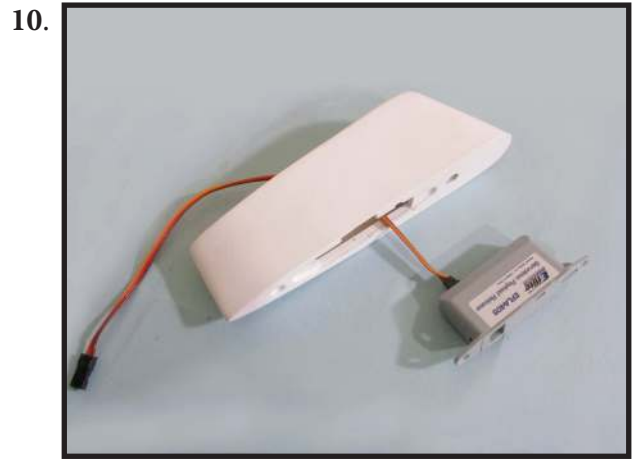
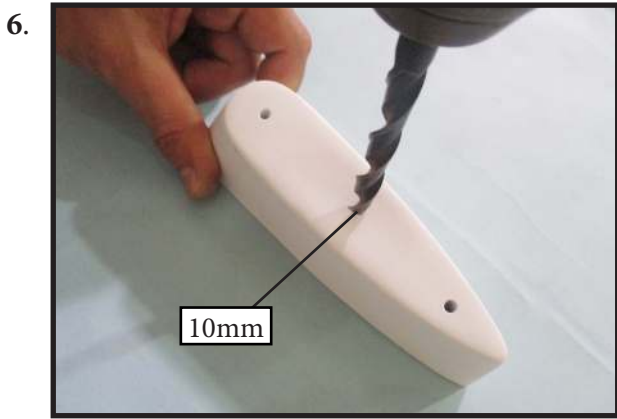

Install drop tank/bomb releases as shown.

You should buy this to use.

E-flite - EFLA405 ; E-flite - EFLA406

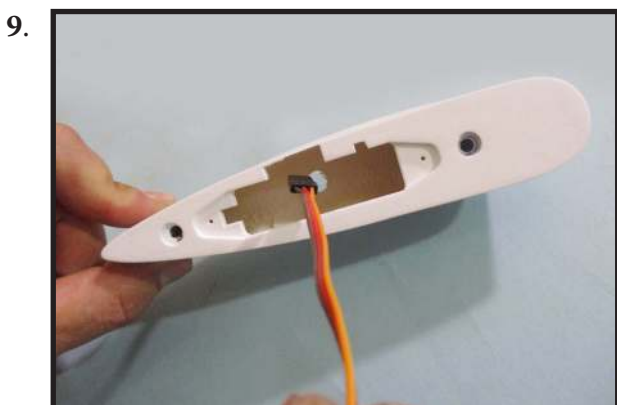
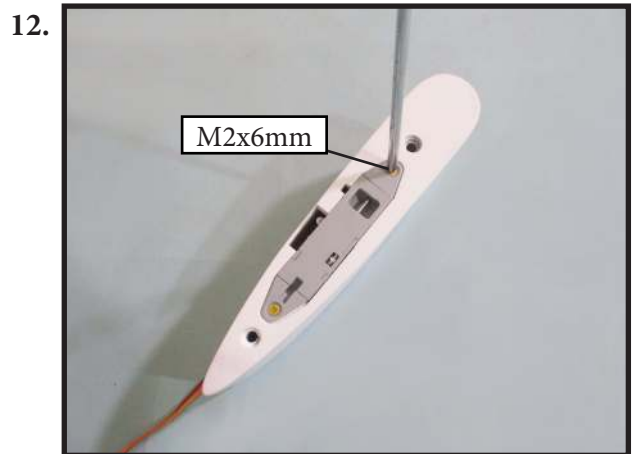

14.

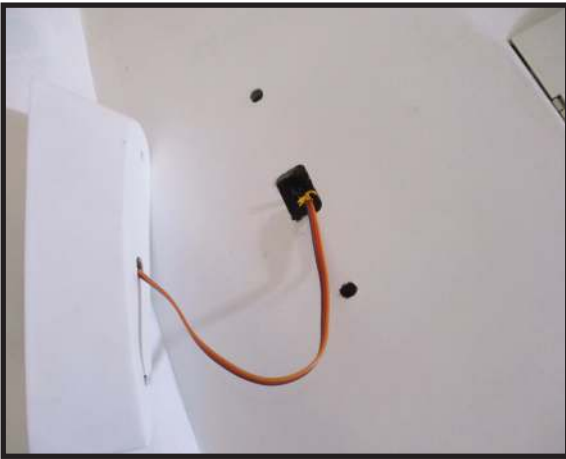

18.



15.



19.

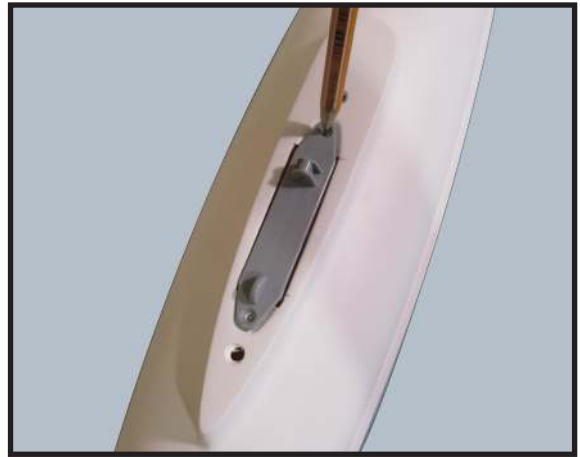

16.



20.

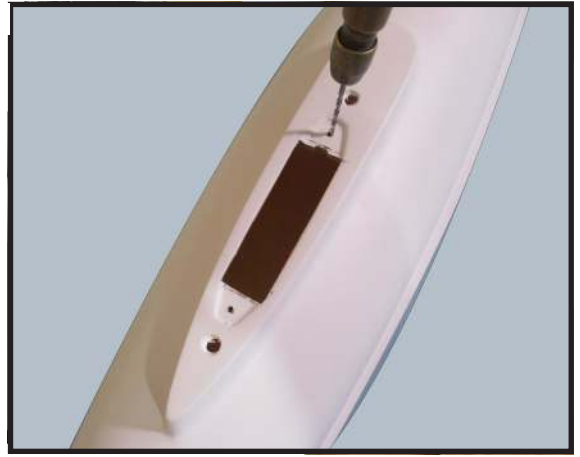

17.

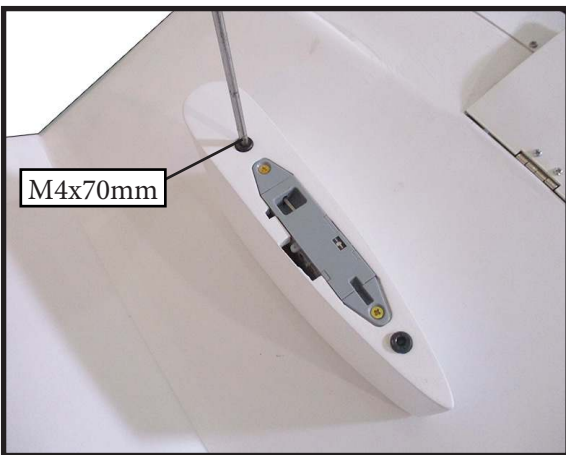

21.



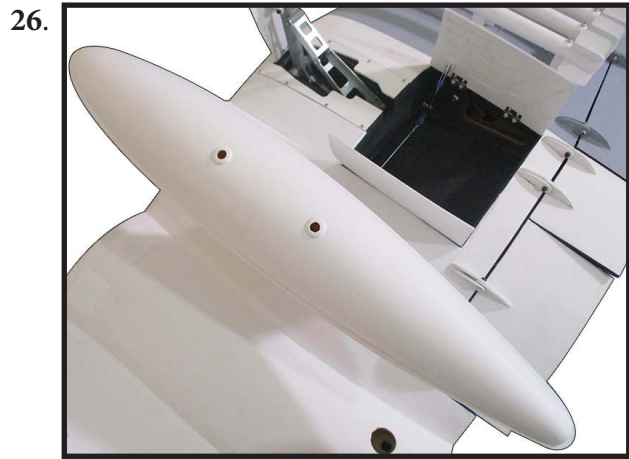
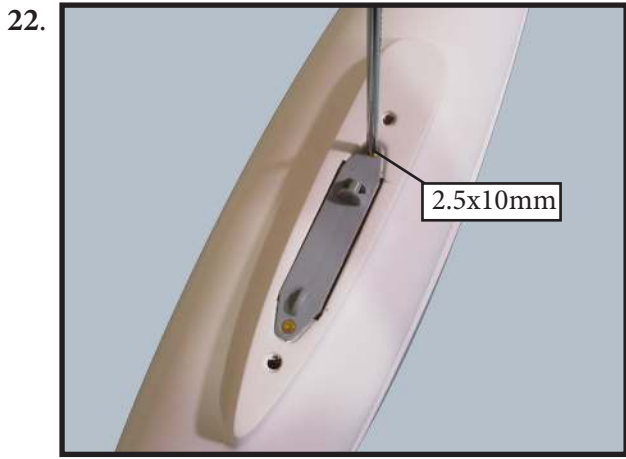

Install the drop tank, please see the picture below.

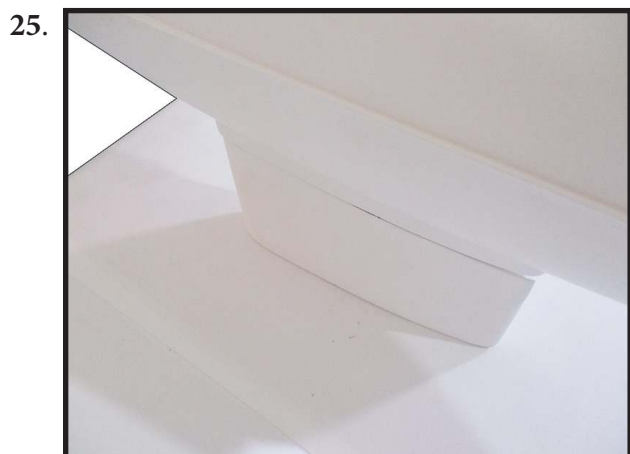

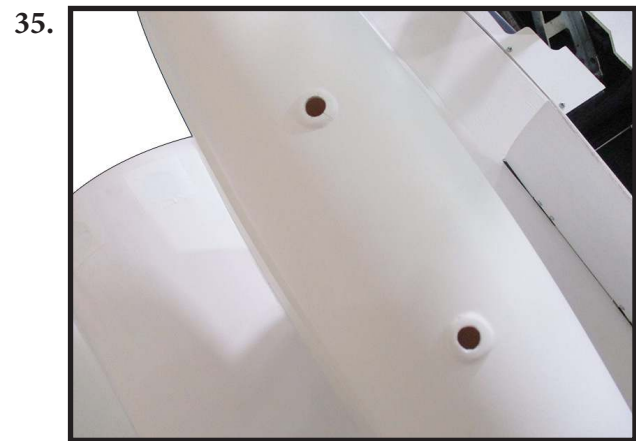
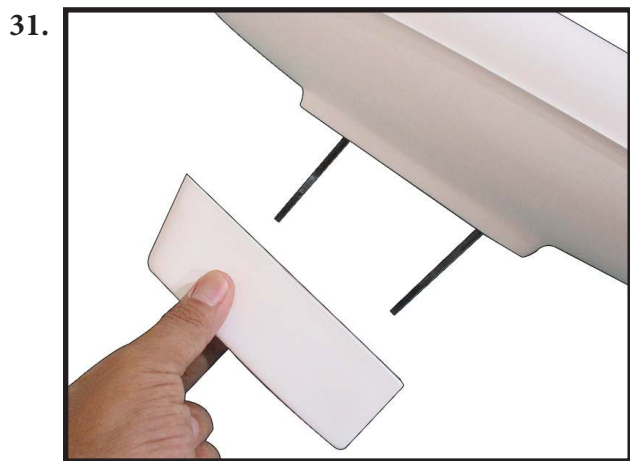
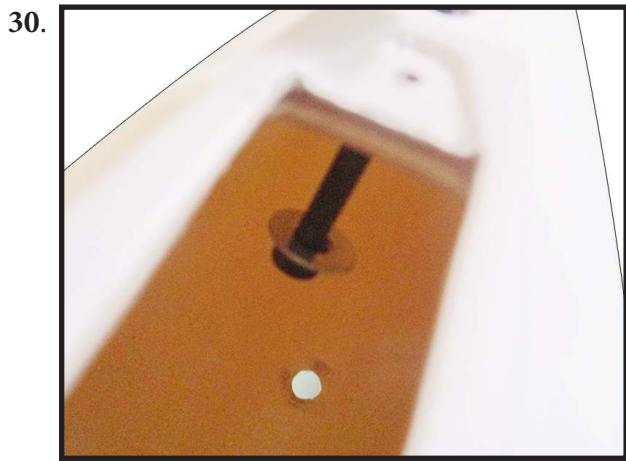

WING ASSEMBLY

Please study images below.



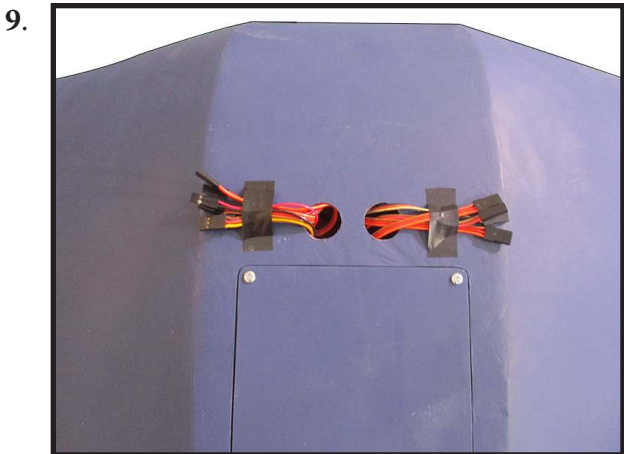
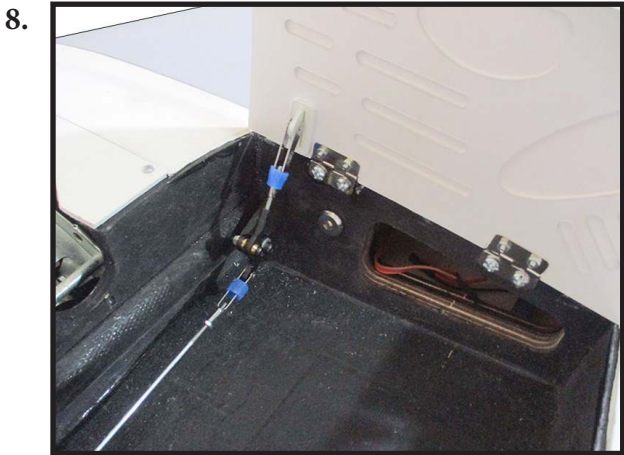
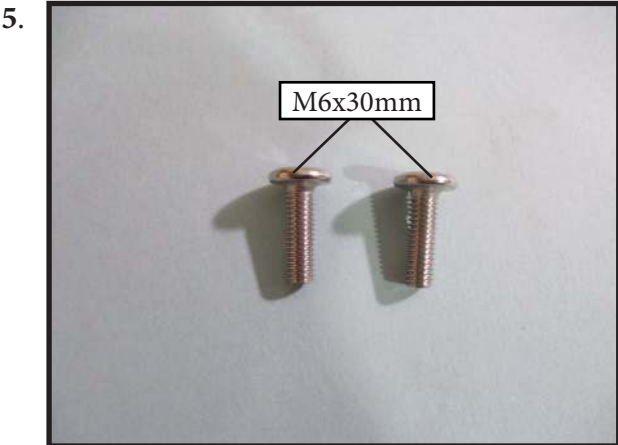
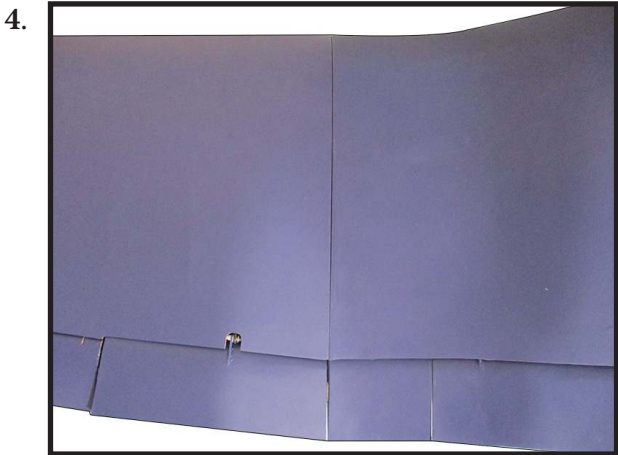
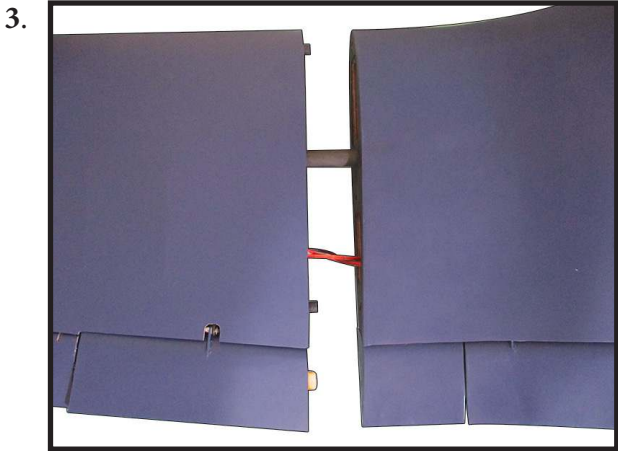
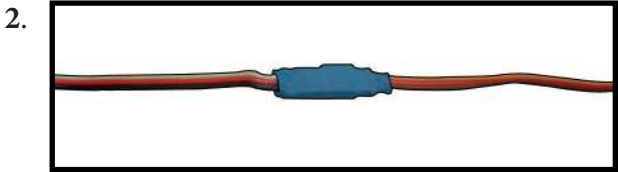

Assembly the plastic decor cover at the bottom of center wing.

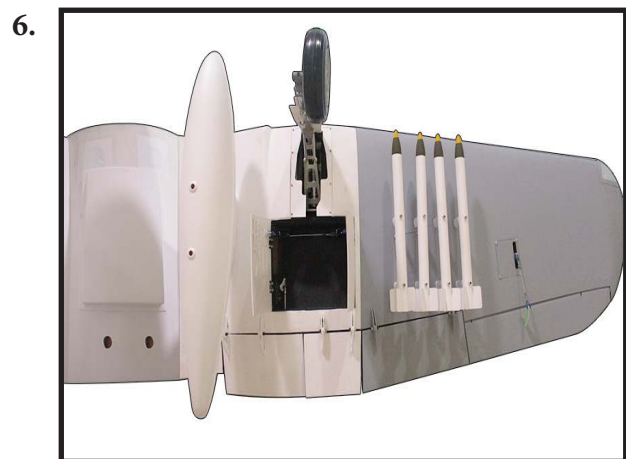
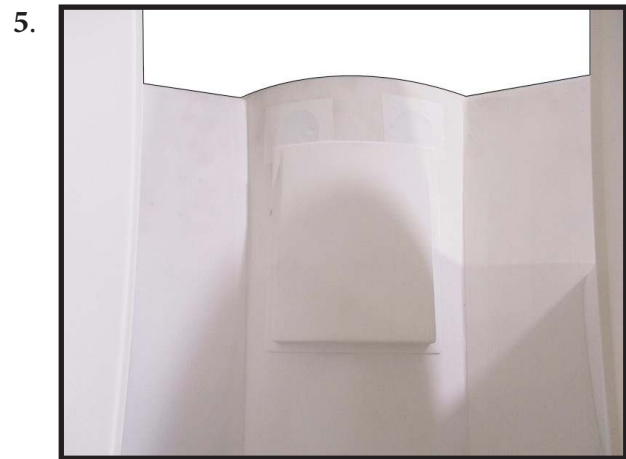
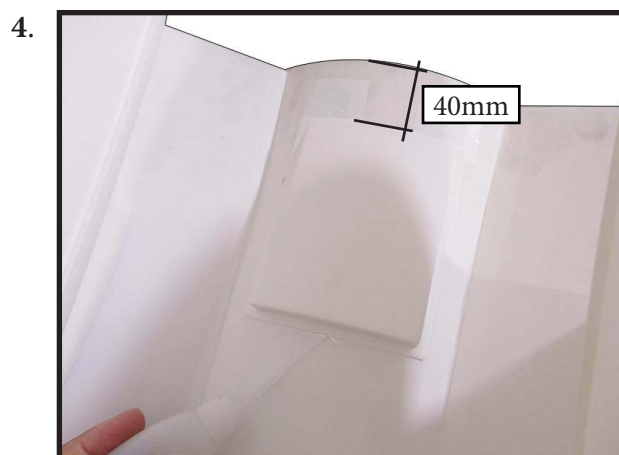

INSTALLING THE FUSELAGE SERVOS

 Because the size of servos differ, you may need to adjust the size of the pre-cut opening in the mount. The notch in the sides of the mount allow the servo lead to pass through.

Secure the servos with the screws provided with your servo.

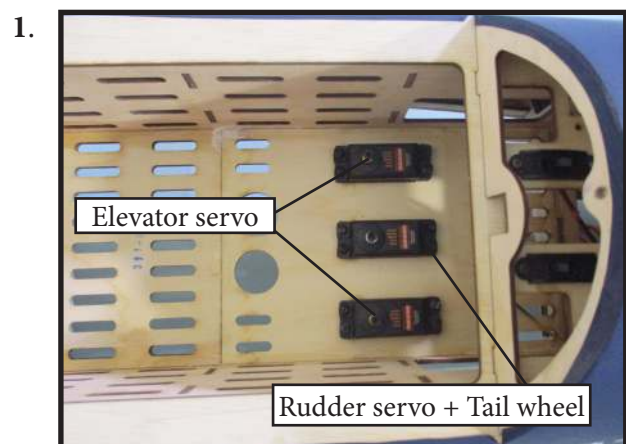

THROTTLE SERVO ARM INSTALLATION

Install adjustable servo connector on the servo arm and set aside for now.

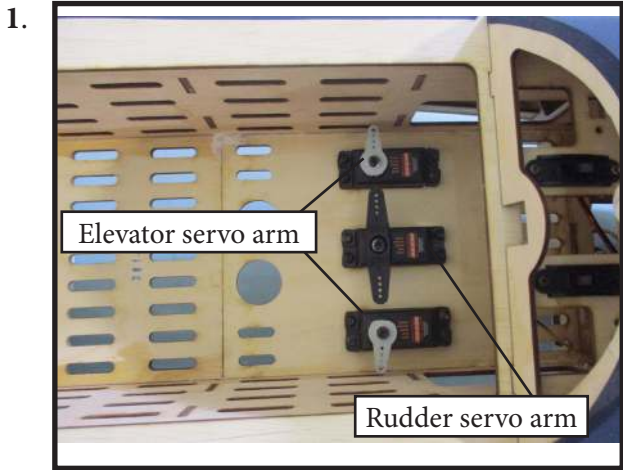

Install the rudder and elevator servo arms as shown above.

INSTALLING THE RECEIVER SWITCH

Install the switch into the precut hole in the side of fuselage, or you may hide switches under main hatch on a custom home made switch plate as desired.

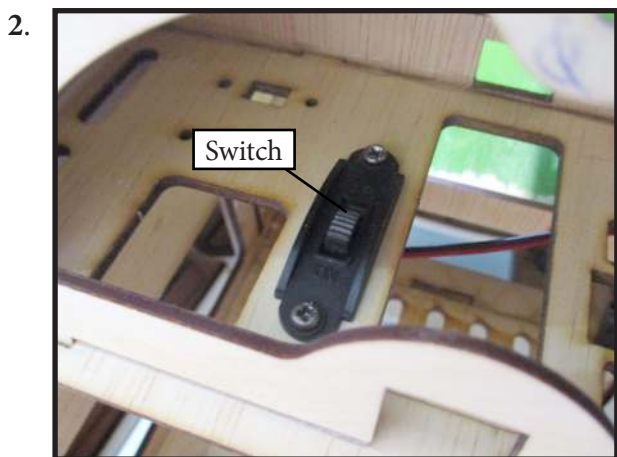
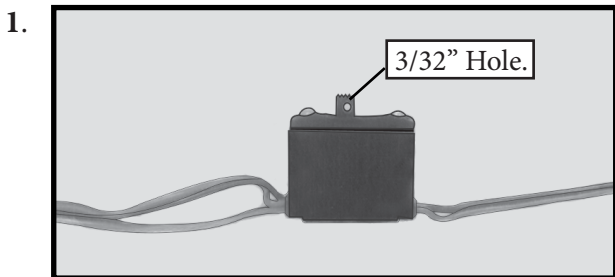

INSTALLING THE ENGINE SWITCH

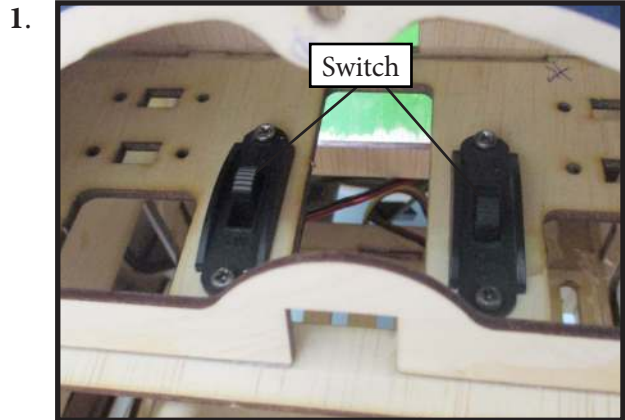

INSTALLING THE STOPPER ASSEMBLY

Using a modeling knife, carefully cut off the rear portion of one of the 3 nylon tubes leaving 1/2" protruding from the rear of the stopper. This will be the fuel pick up tube.

Using a modeling knife, cut one length of silicone fuel line. Connect one end of the line to the weighted fuel pick up and the other end to the nylon pick up tube.



Carefully bend the second nylon tube up at a 45° angle. This tube is the vent tube.

Test fit the stopper assembly into the tank. It may be necessary to remove some of the flashing around the tank opening using a modeling knife. If flashing is present, make sure none falls into the tank.

With the stopper assembly in place, the weighted pick-up should rest away from the rear of the tank and move freely inside the tank. The top of the vent tube should rest just below the top of the tank. It should not touch the top of the tank.

When satisfied with the alignment of the stopper assembly tighten the 3 x 20mm machine screw until the rubber stopper expands and seals the tank opening. Do not over-tighten the assembly as this could cause the tank to split.

FUEL TANK INSTALLATION



 *You should mark which tube is the vent and which is the fuel pickup when you attach fuel tubing to the tubes in the stopper. Once the tank is installed inside the fuselage, it may be difficult to determine which is which.*

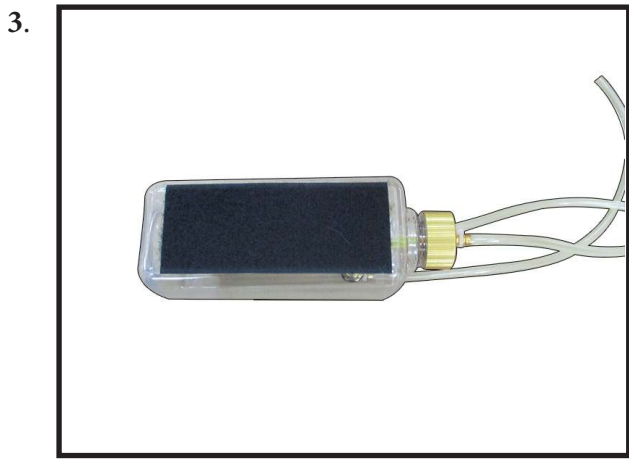
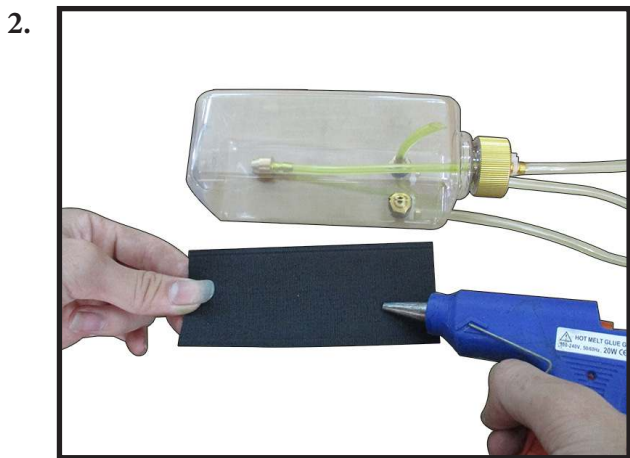

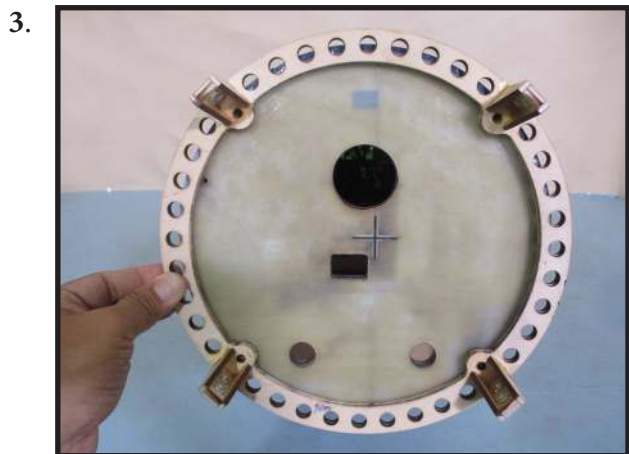
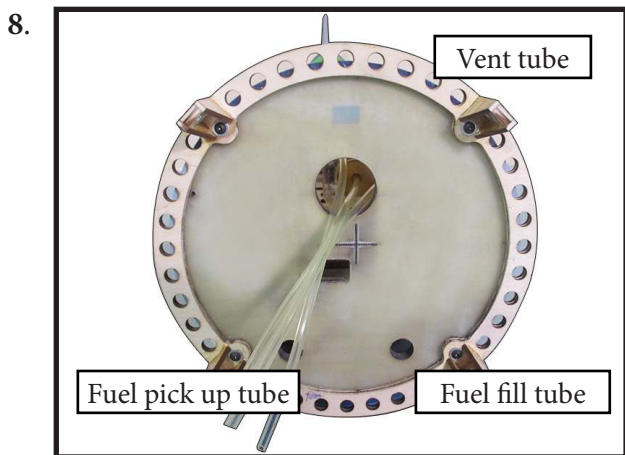
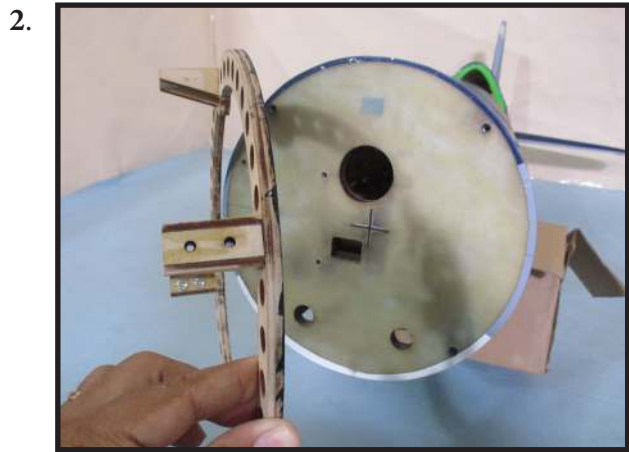
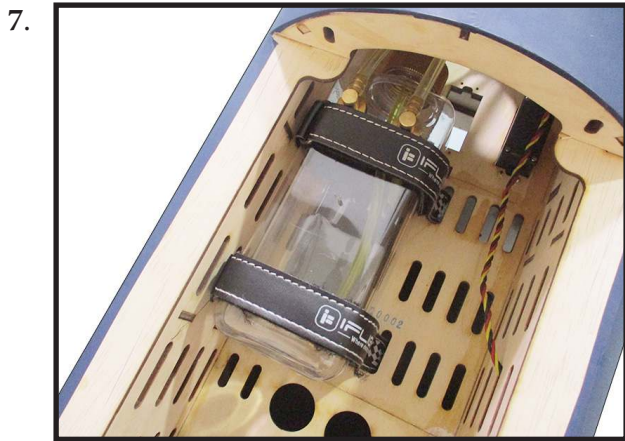

Later you will connect the lines from the tank to the engine and muffler. The vent line will connect to the muffler and the line from the clunk to the carburetor.

! *Blow through one of the lines to ensure the fuel lines have not become kinked inside the fuel tank compartment. Air should flow through easily.*

MOUNTING THE ENGINE

Please study the images below.

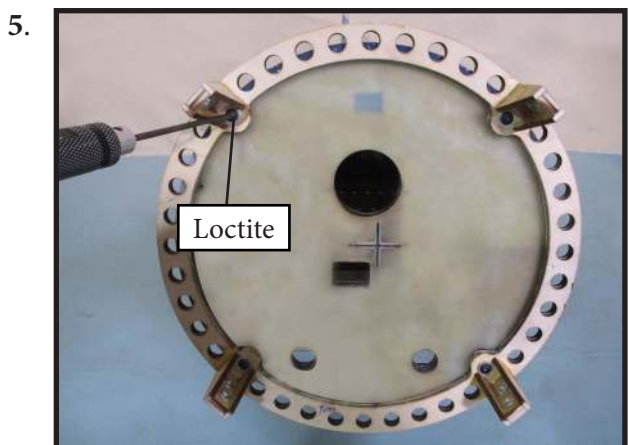
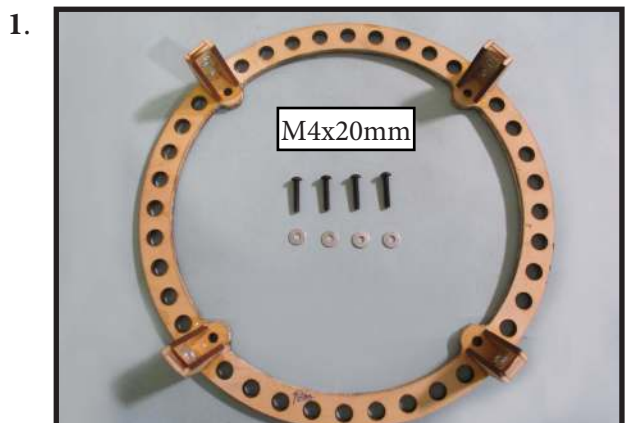
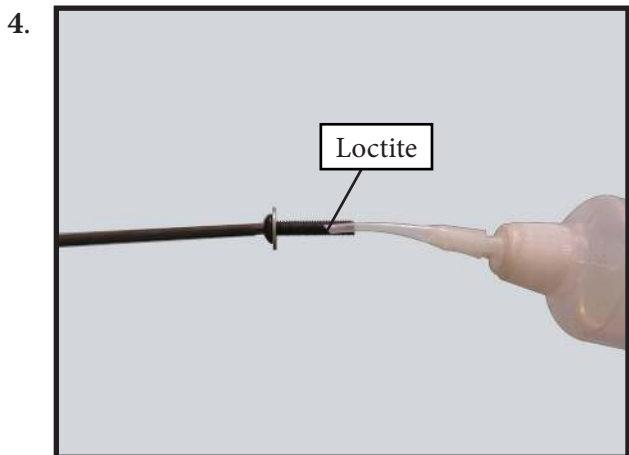

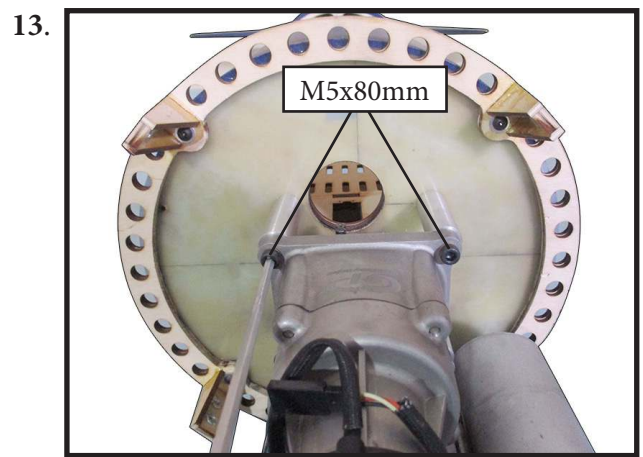
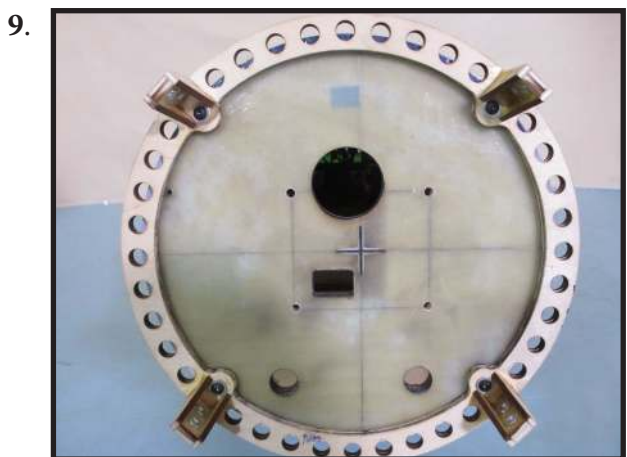
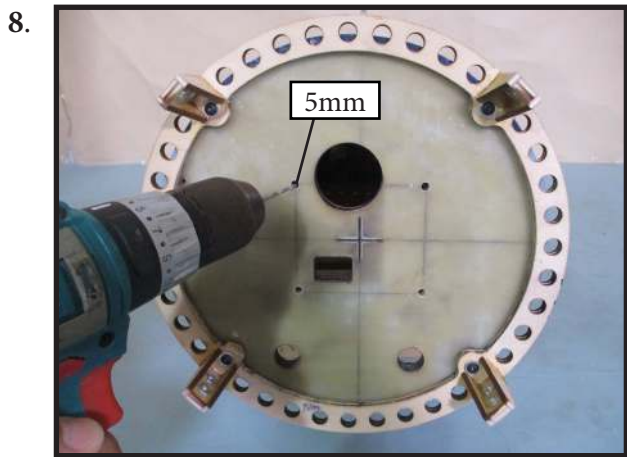
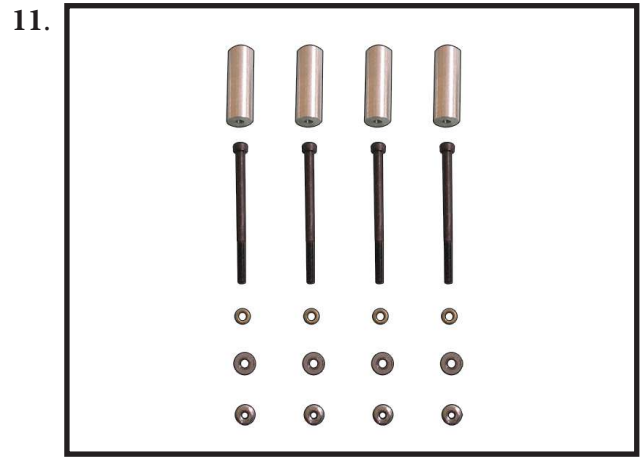
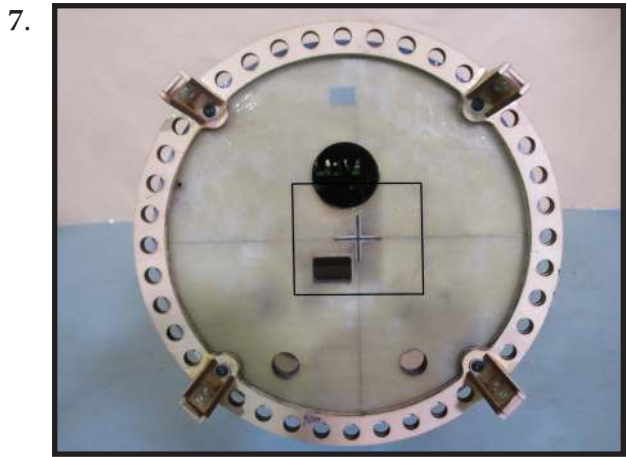
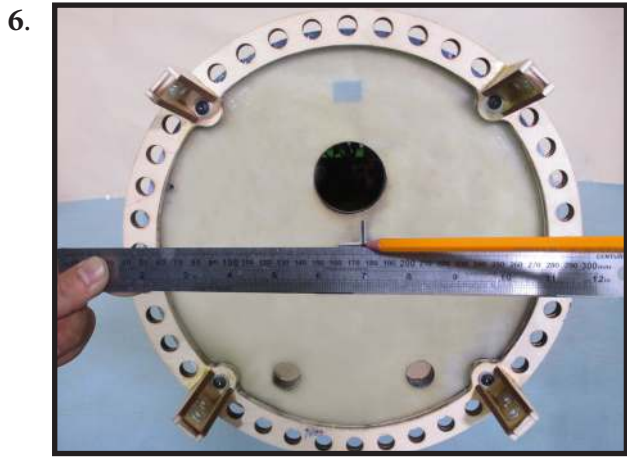

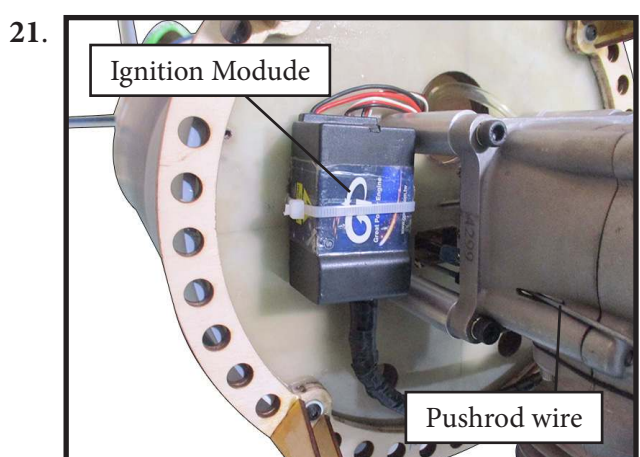
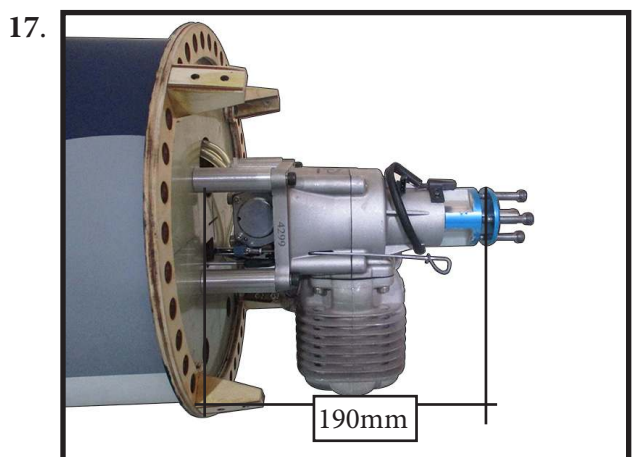
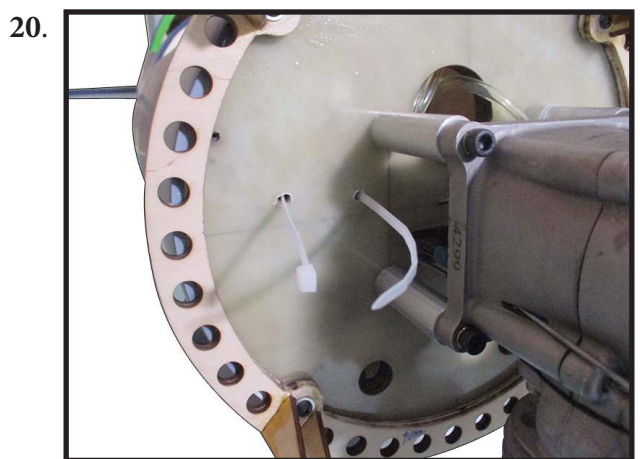
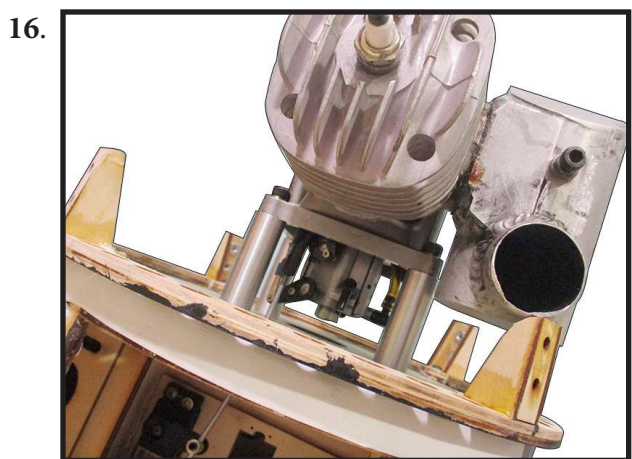
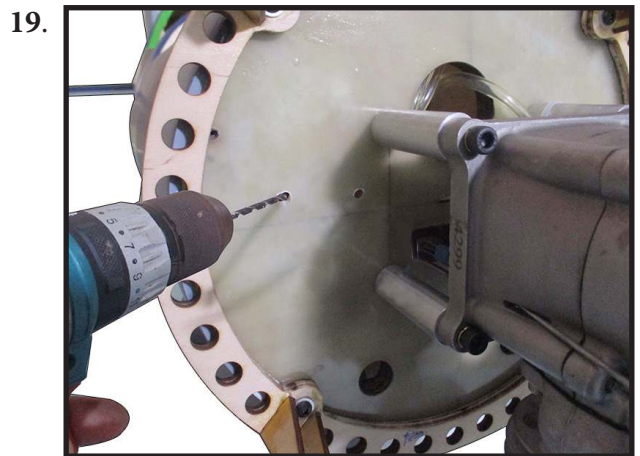
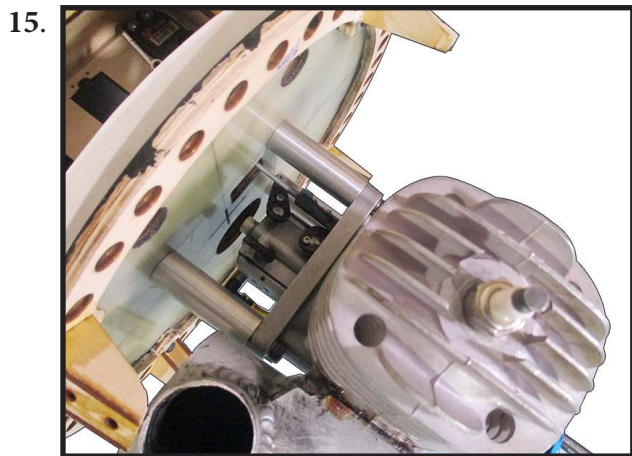
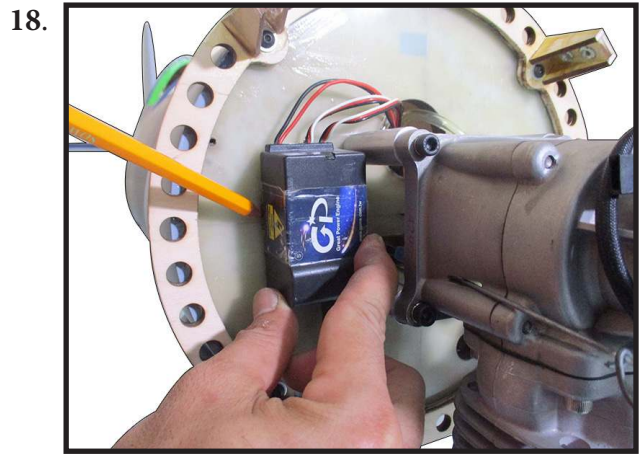
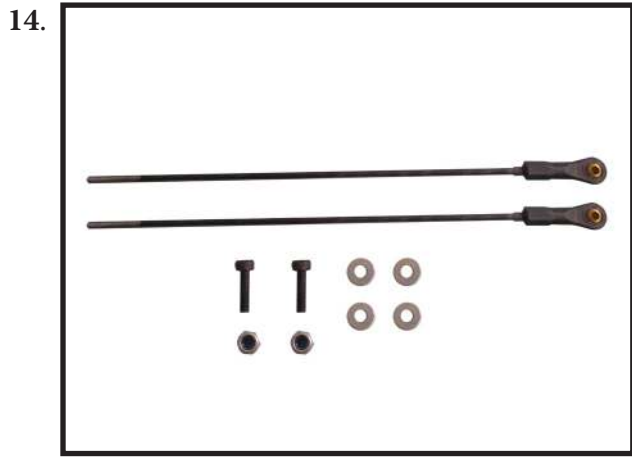

22.

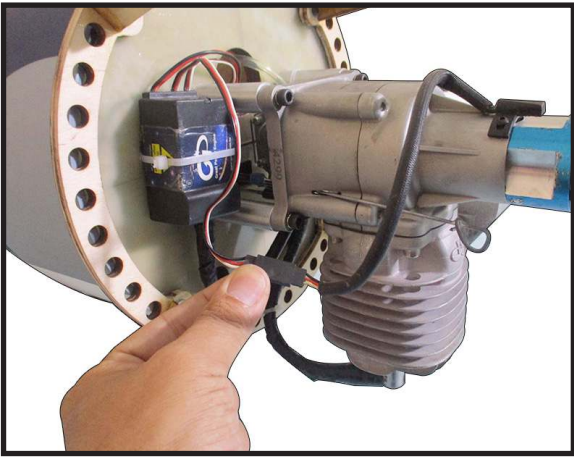

26.



23.

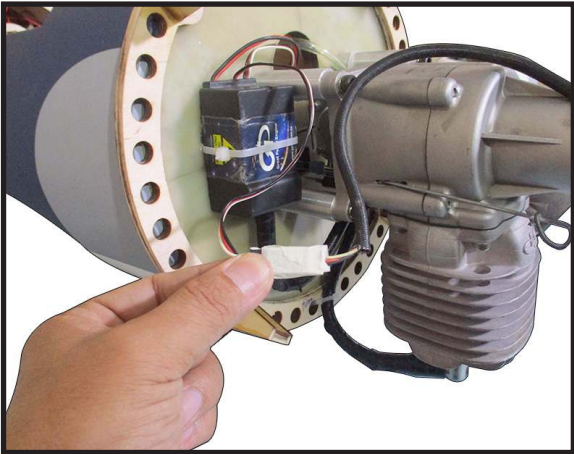

27.



24.

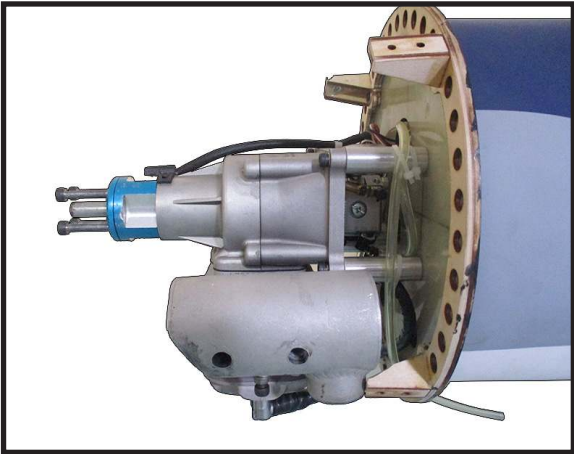

28.



25.



29.

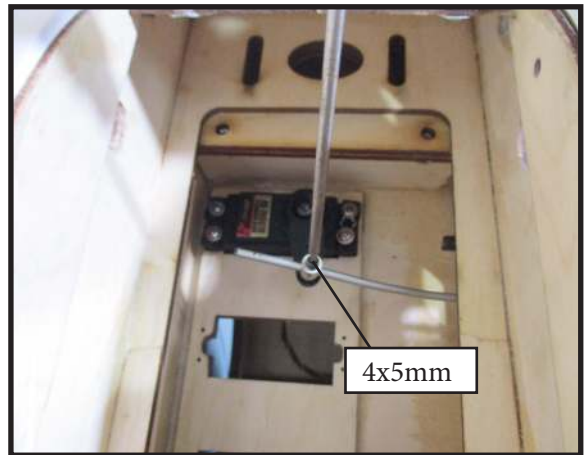

Move the throttle stick to the closed position and move the carburetor to closed.

Use a 4x5mm hex wrench to tighten the screw that secures the throttle pushrod wire. Make sure to use threadlock on the screw so it does not vibrate loose.



Reinstall the servo horn by sliding the connector over the pushrod wire. Center the throttle stick and trim and install the servo horn perpendicular to the servo center line.

MOUNTING THE ENGINE 4 STROKE
Saito FG-90R3

Please study the images be low.

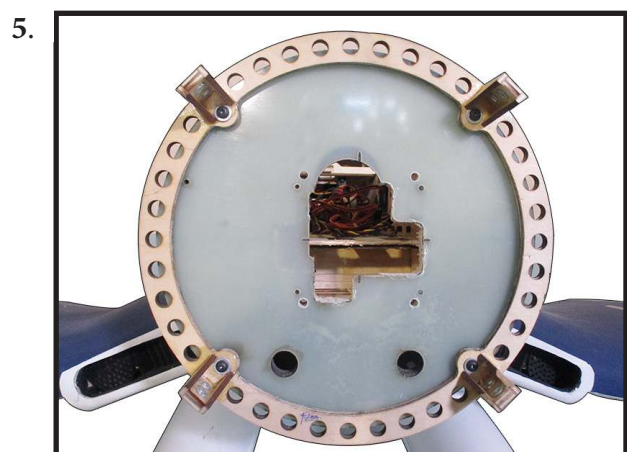
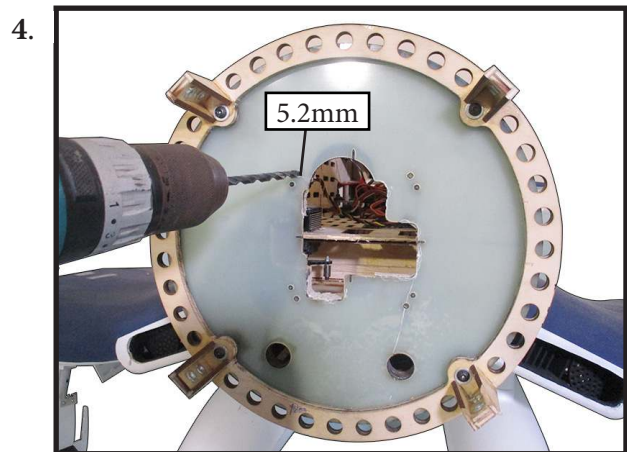
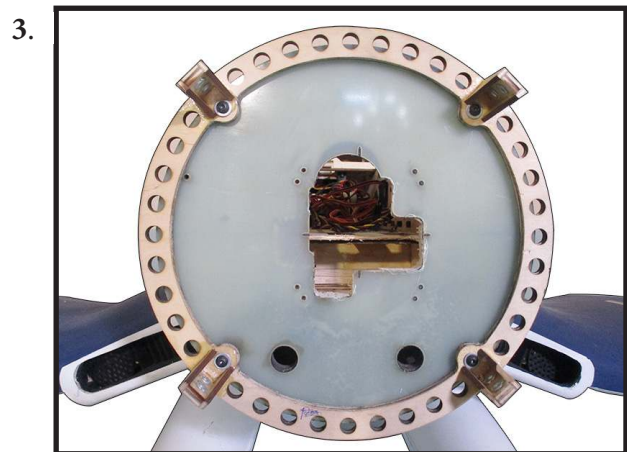
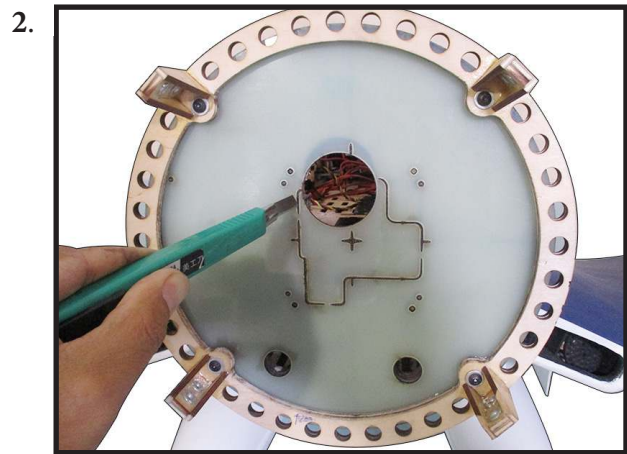

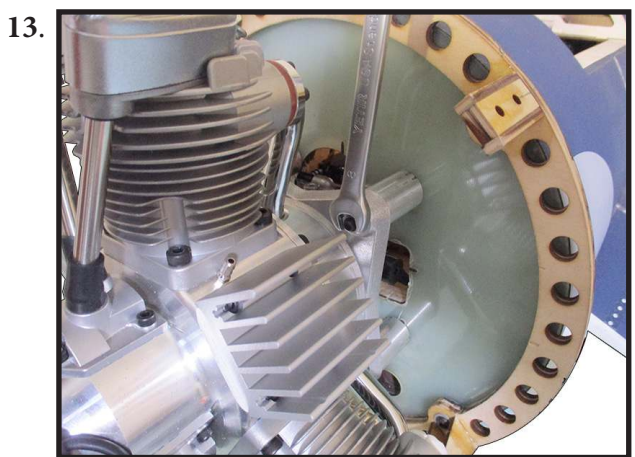
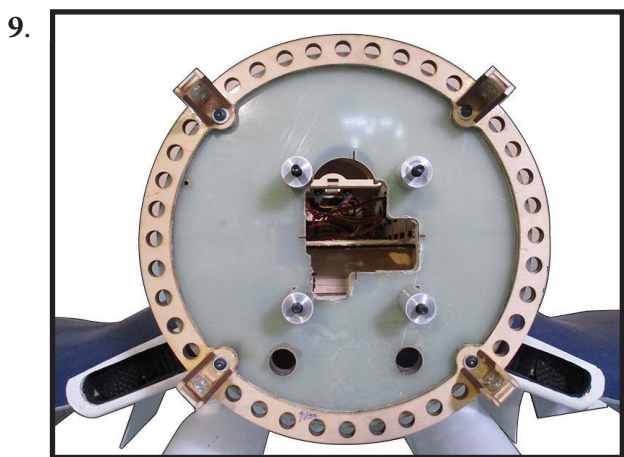
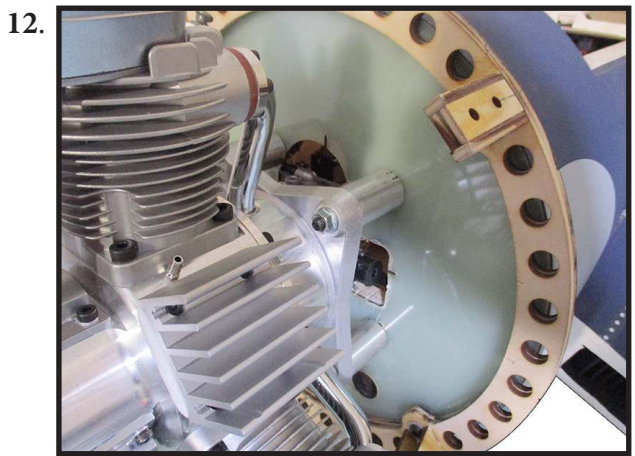
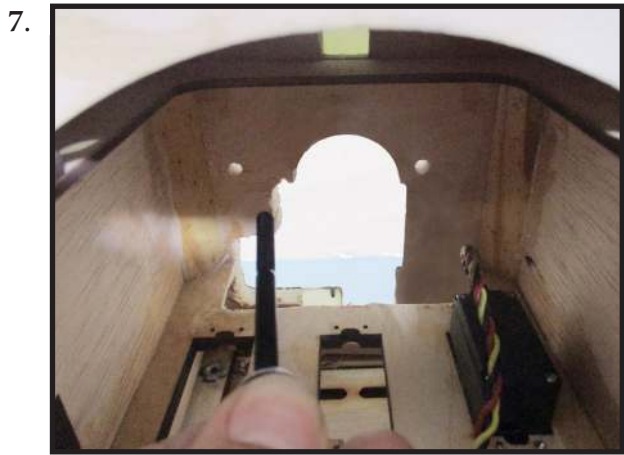
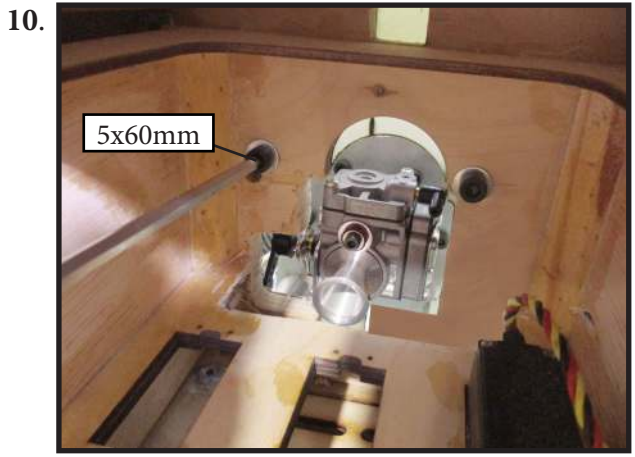

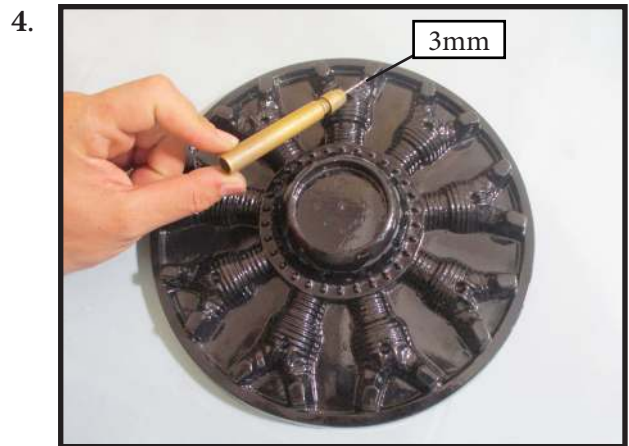
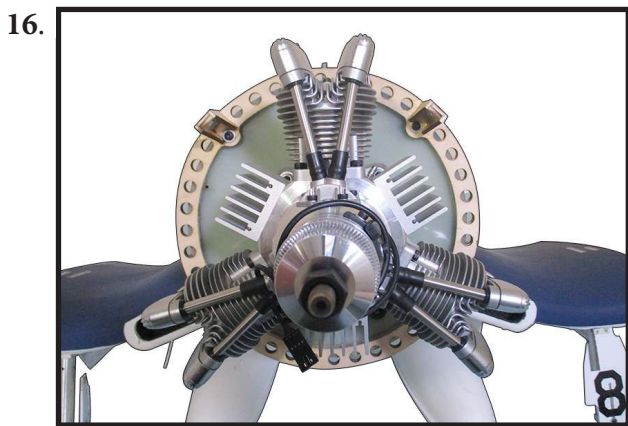
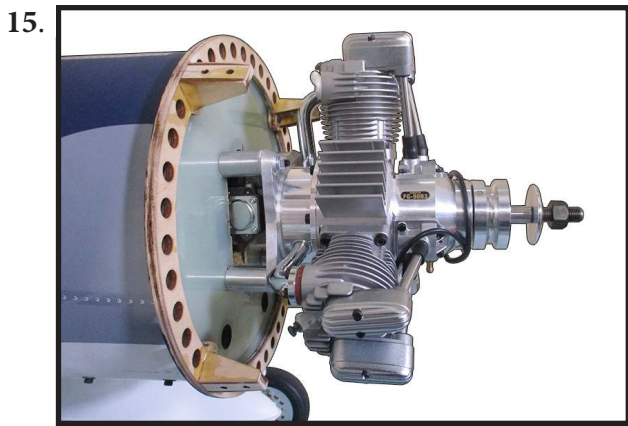
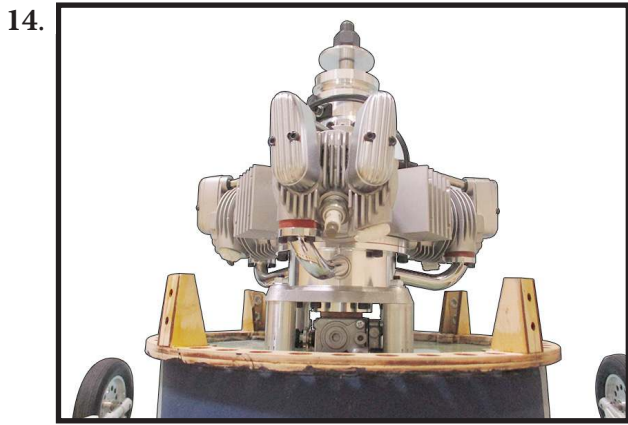

COWLING & ENGINE BAFFLE

Please study images below.



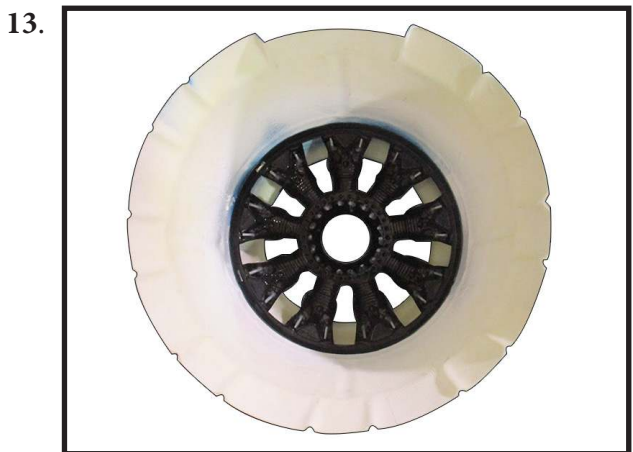
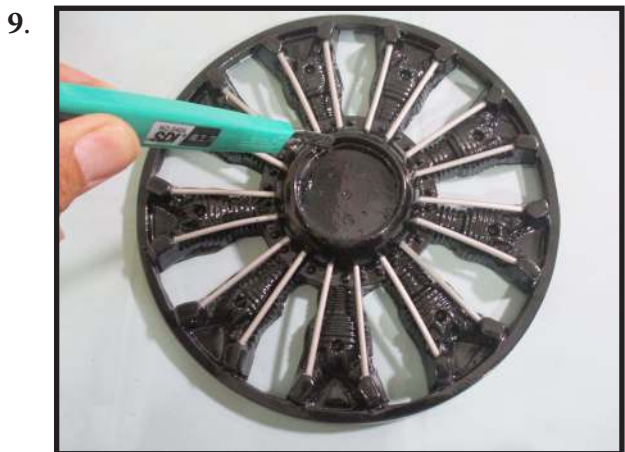



Tape the cowl to the fuselage using low-tack tape.

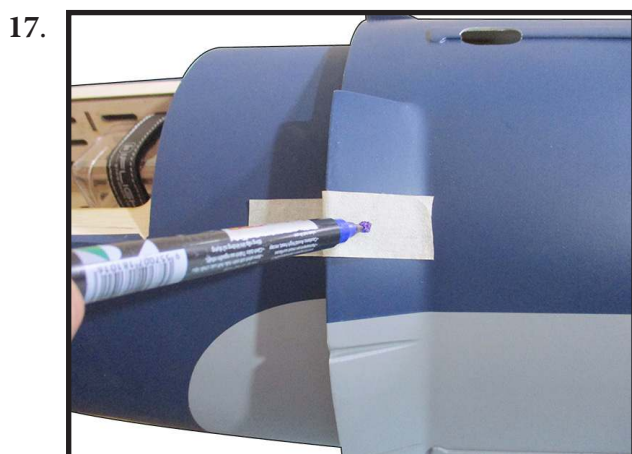
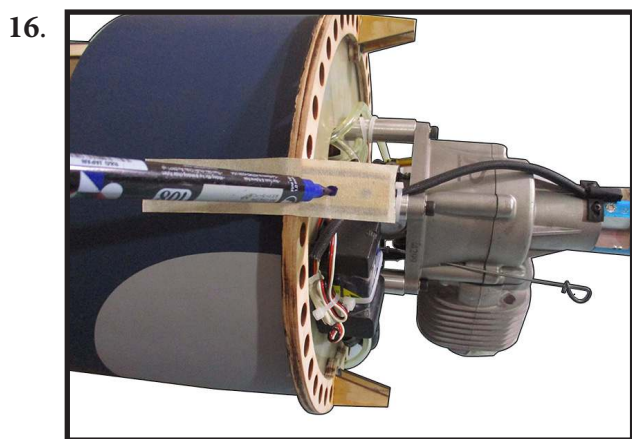

Use a drill and drill bit to drill the holes for the cowl mounting screws. Make sure the cowl position is correct before drilling each hole.

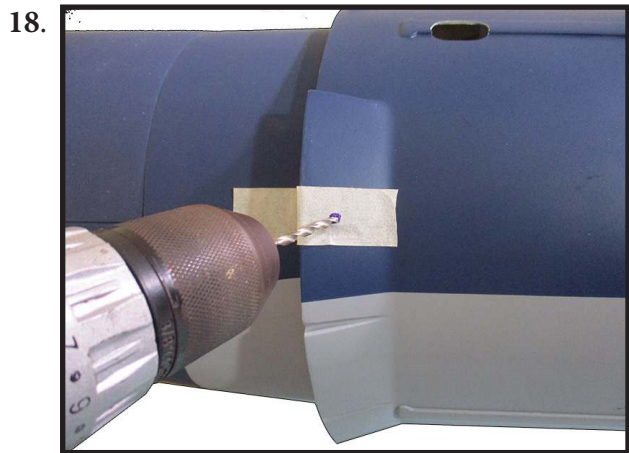

Install the muffler onto the engine and make the cutout in the cowl for muffler clearance. Connect the fuel and pressure lines to the carburetor, muffler and fuel filler valve. Secure the cowl to fuselage using the M3x10mm socket head screws. Putting a small length of silicone fuel tube under the head of the screw helps with vibration.

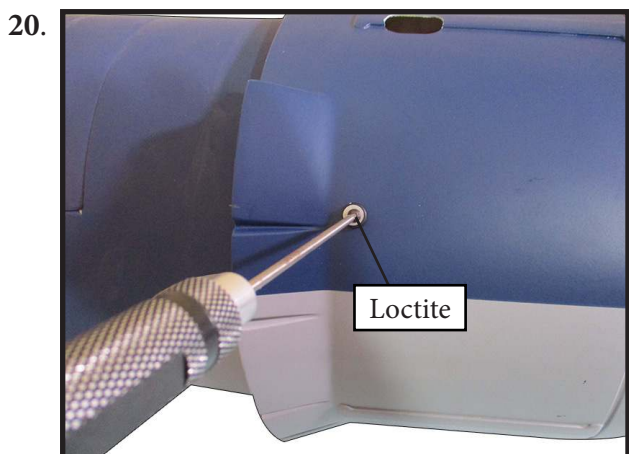
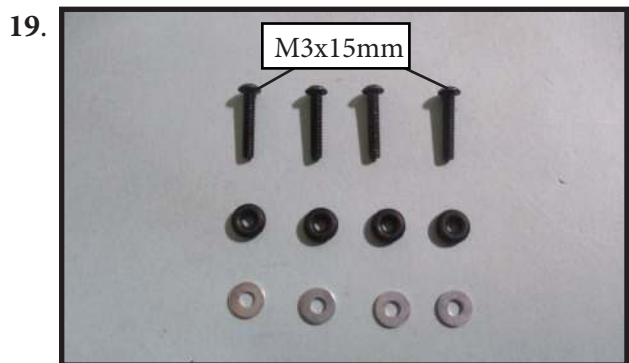

21.



22.



23.



24.



ELECTRIC POWER CONVERSION

Locate the items necessary to install the electric power conversion included with your model.

1.

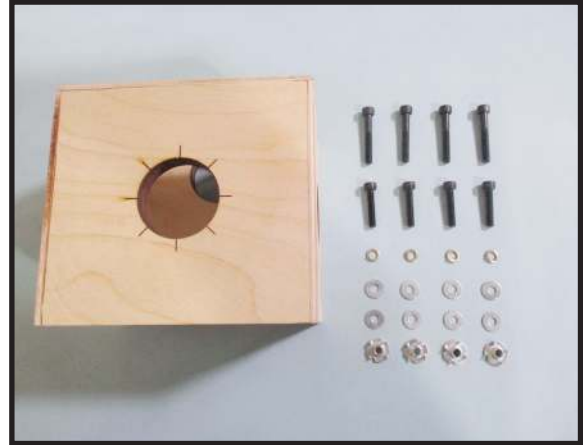

Recommend the items necessary to install the electric power conversion parts included with your model.

- **Motor: 360/6000watt**
- **ESC: 200A**
- **12S Lipo**

2.

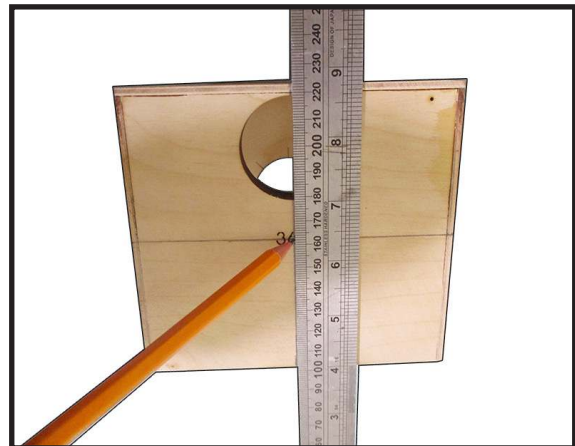

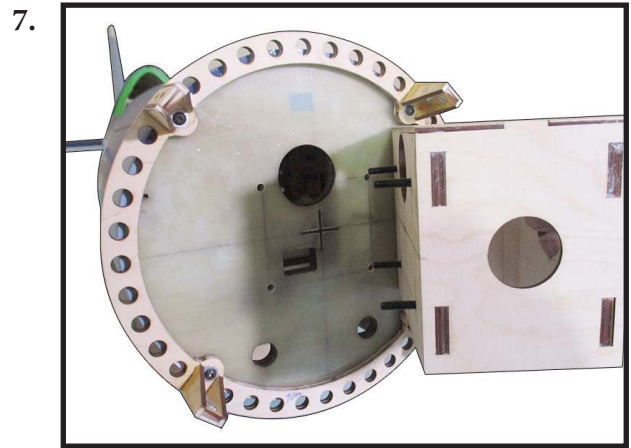
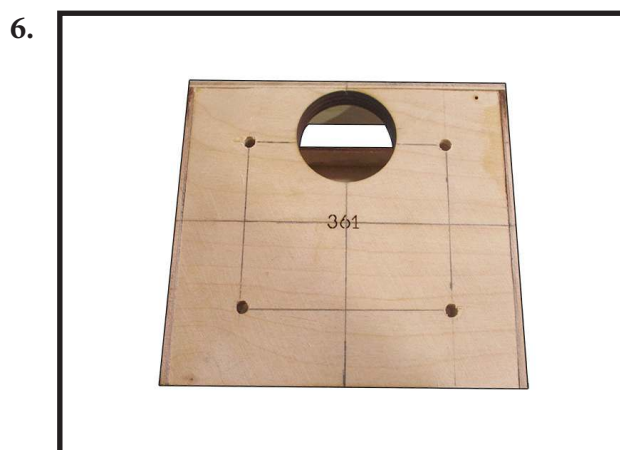
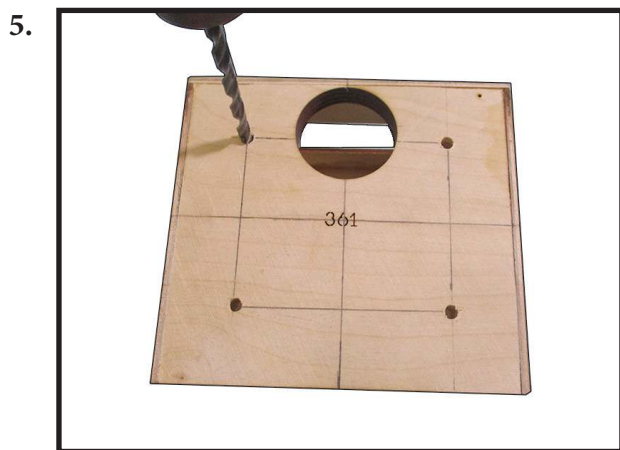
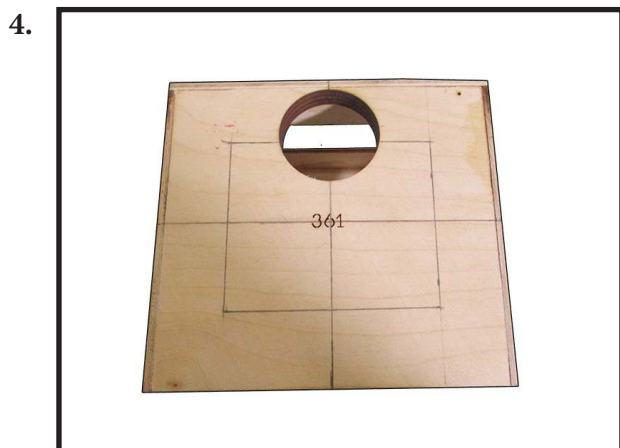
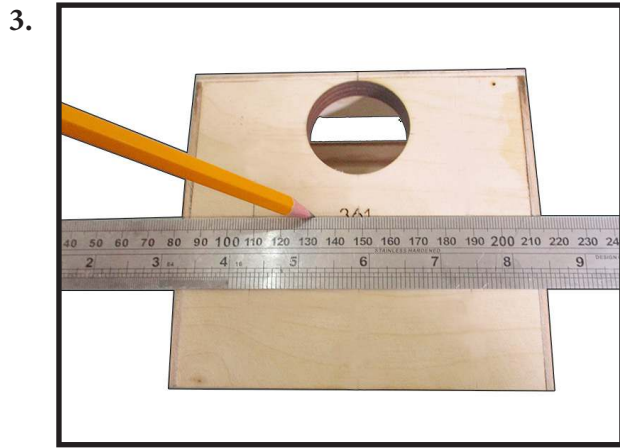

Attach the electric motor box to the fire-wall centered with the cross lines drawn on the electric motor box and firewall. Using M6x25mm to secure the motor box to the firewall. Please see pictures below.

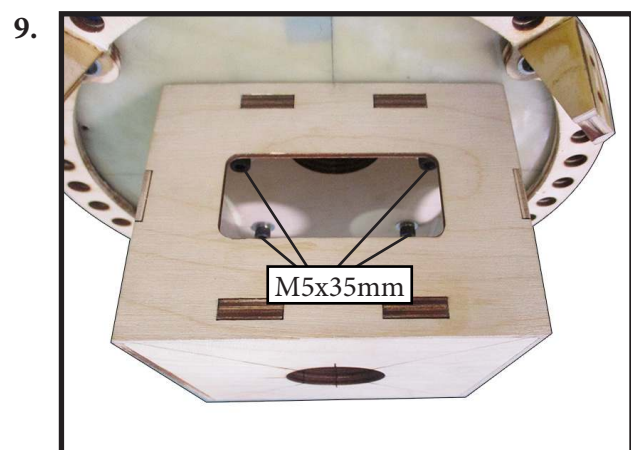
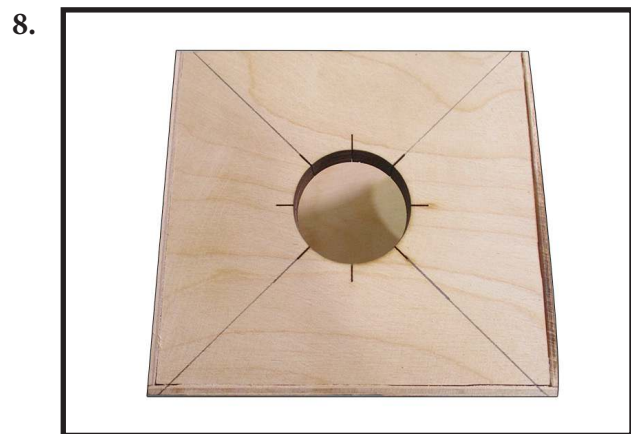

Attach the motor to the front of the electric motor box using four 4mm blind nut, four M6x35mm hex head bolts to secure the motor. Please see picture shown.

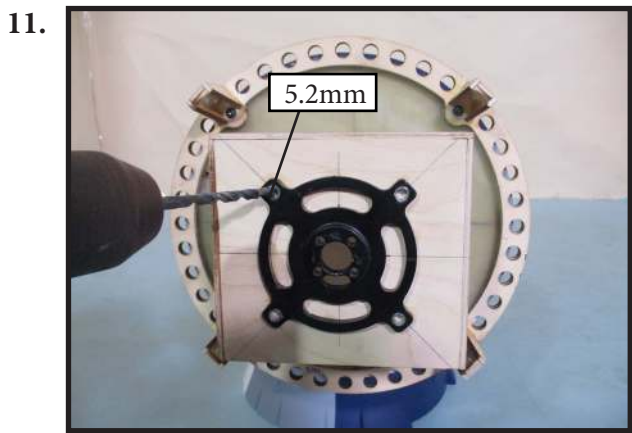
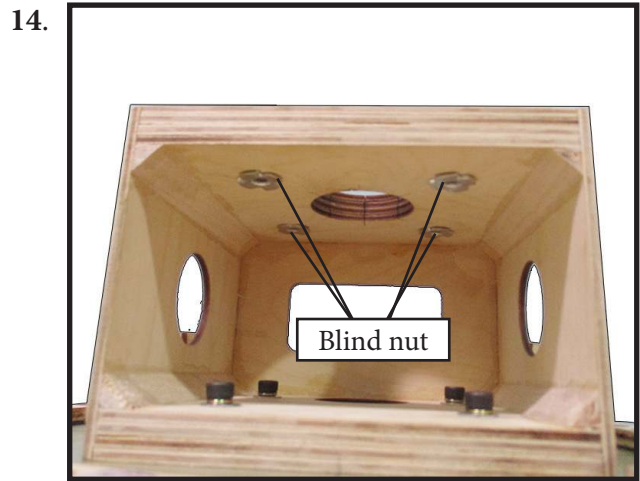

Attach the motor mount to the front of the electric motor box using four 4mm blind nut, four M6x25mm hex head bolts to secure the motor. Please see picture shown.

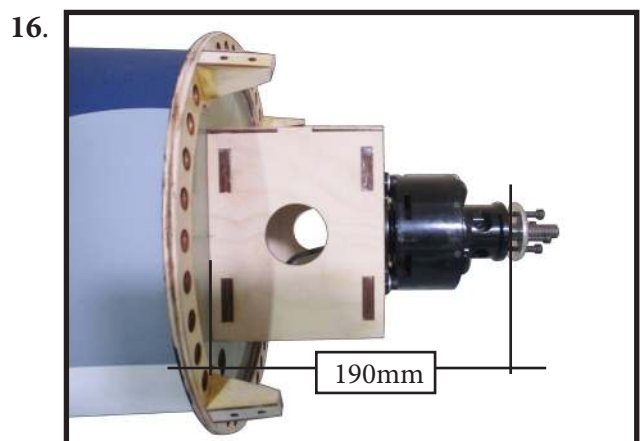
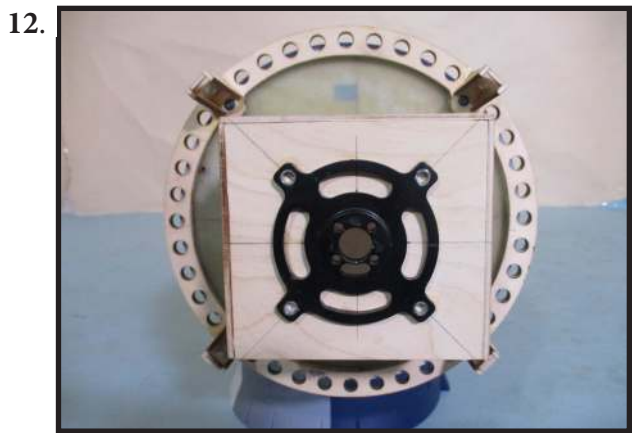
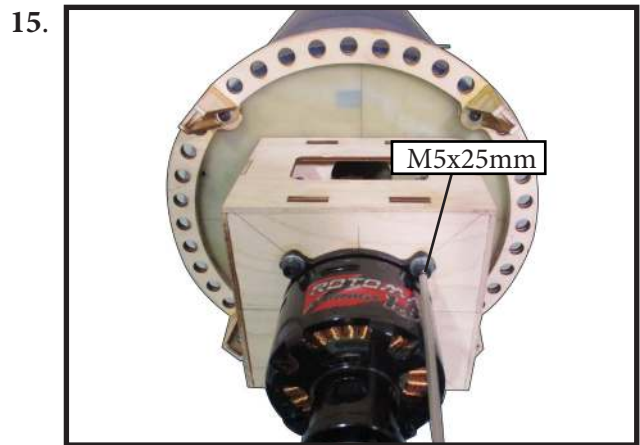

Then, use 5.2mm drill bit to enlarge the holes on the electric motor box.

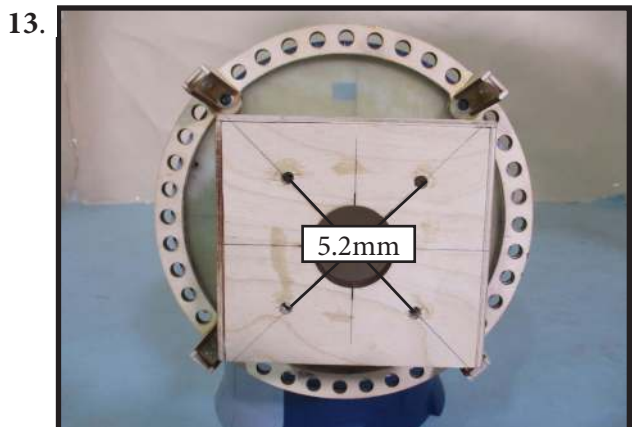

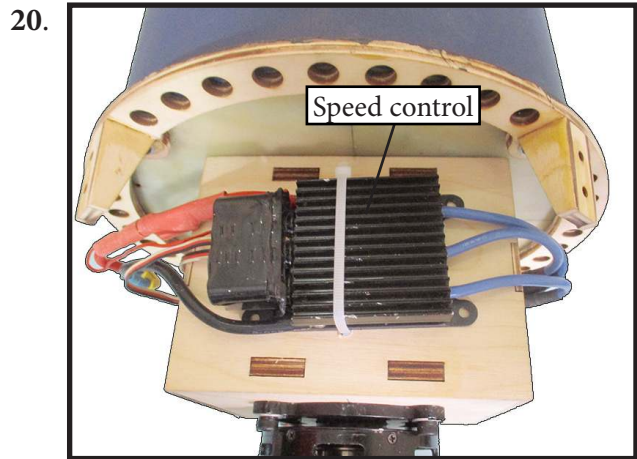
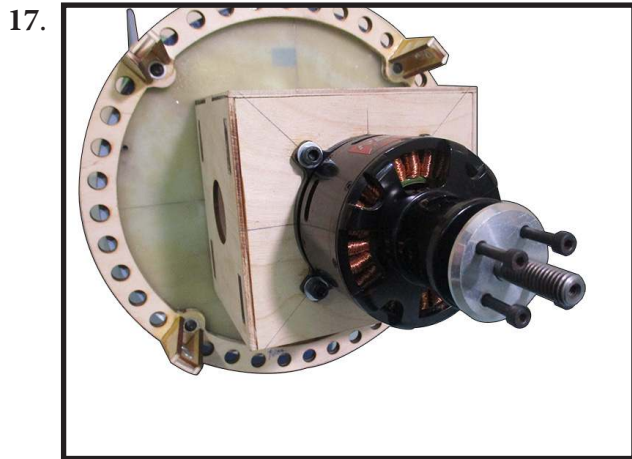

Attach the speed control to the side of the motor box using two-sided tape and tie wraps. Connect the appropriate leads from the speed control to the motor. Make sure the leads will not interfere with the operation of the motor.

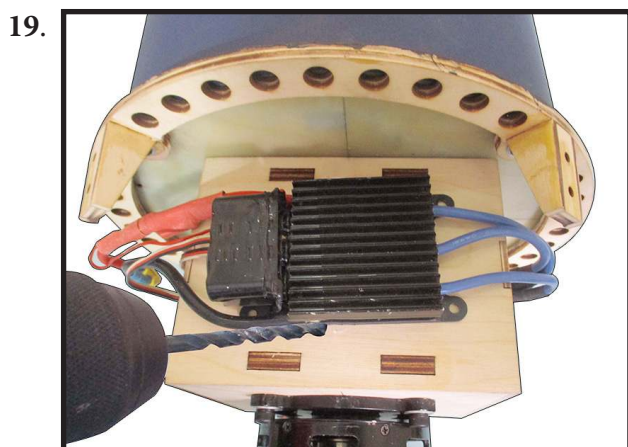
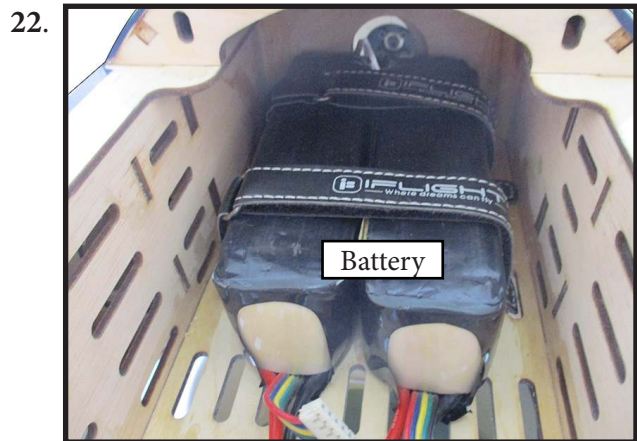
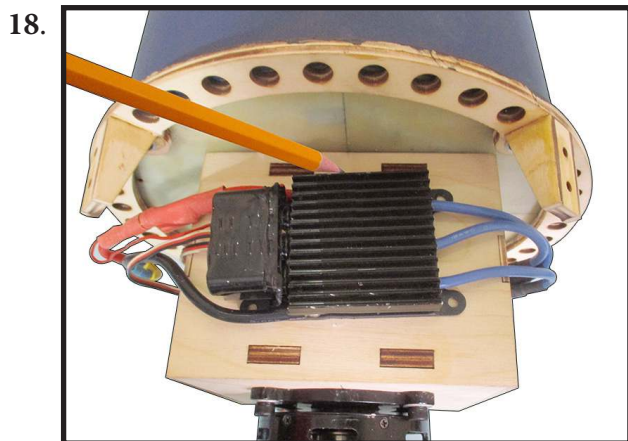

INSTALLING THE PROP/HUB

Install the spinner backplate, propeller and proper hub of your choice.

1.



2.

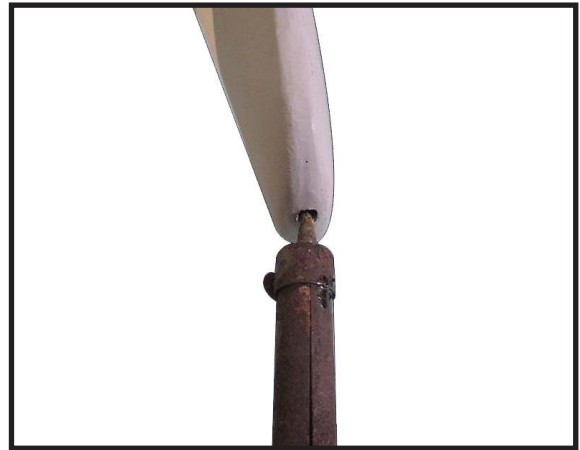

⚠ The propeller should not touch any part of the cowling. If it does, check and adjust engine mounting/cowl spacing as needed to where the propeller will not come in contact with the cowling.

3.



2.



4.

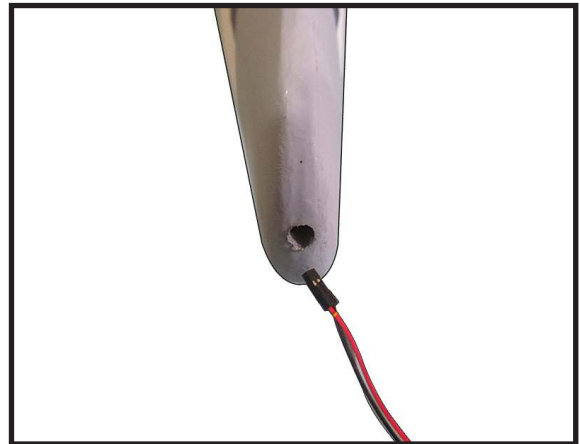

INSTALL LED BULB FOR FUSELAGE

Please study images below.

The 5mm light is located at the back of the same fuselage.

1.

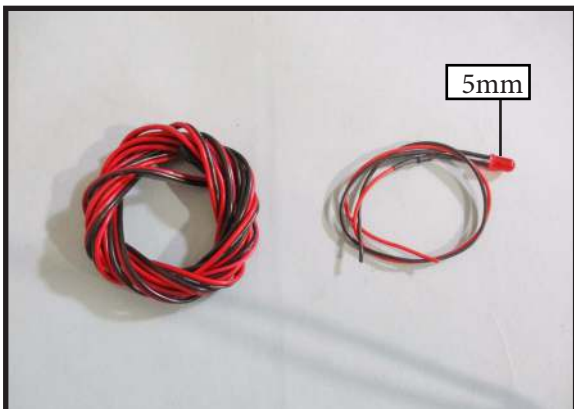

5.

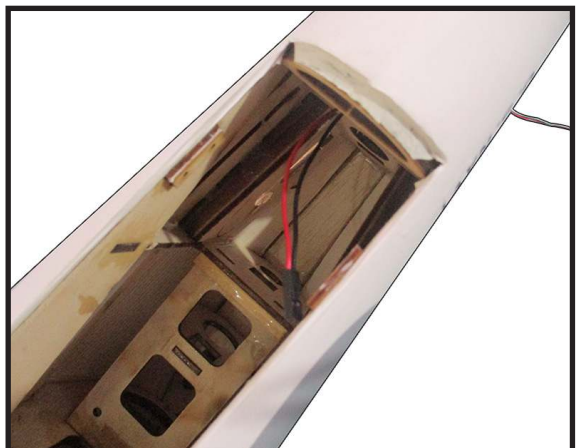

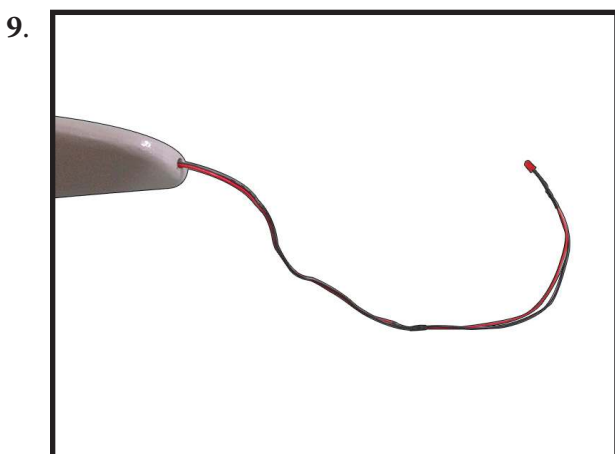
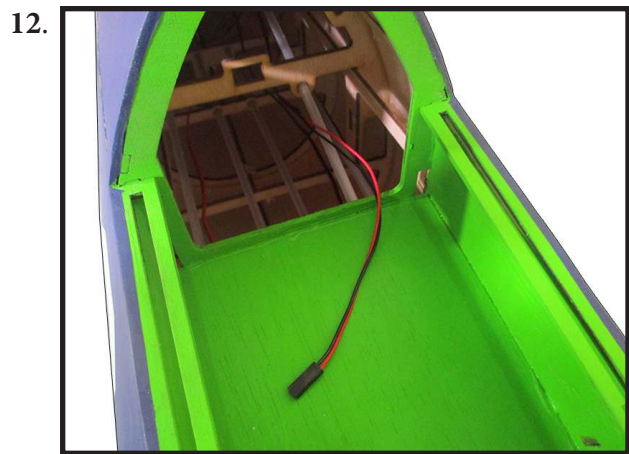
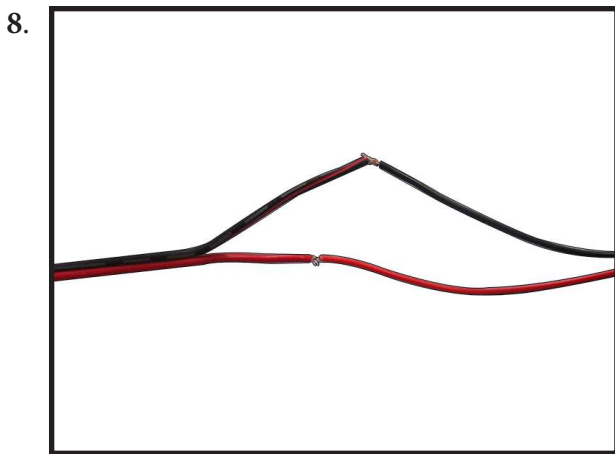
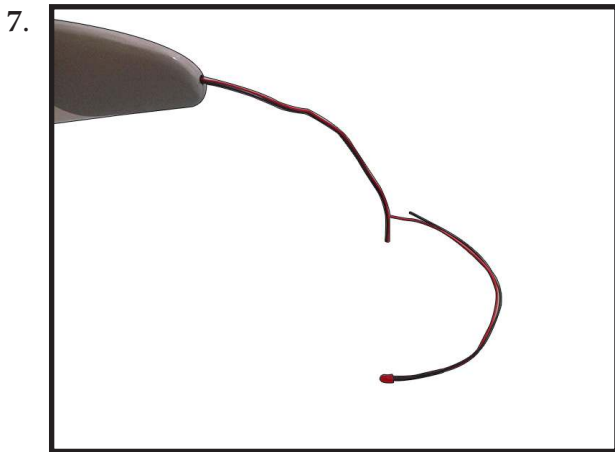
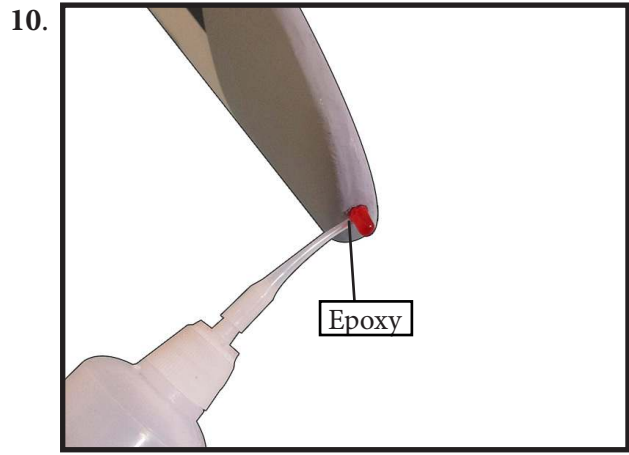
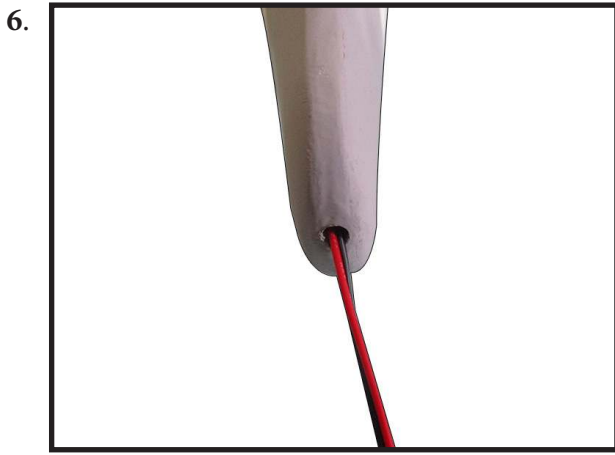

The red light is located in the middle of the fuselage.



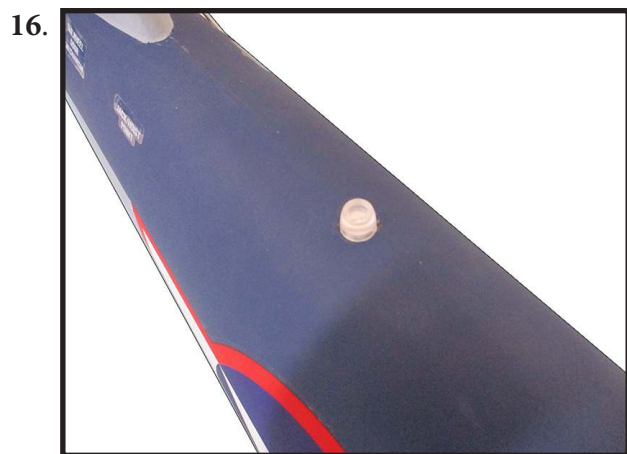
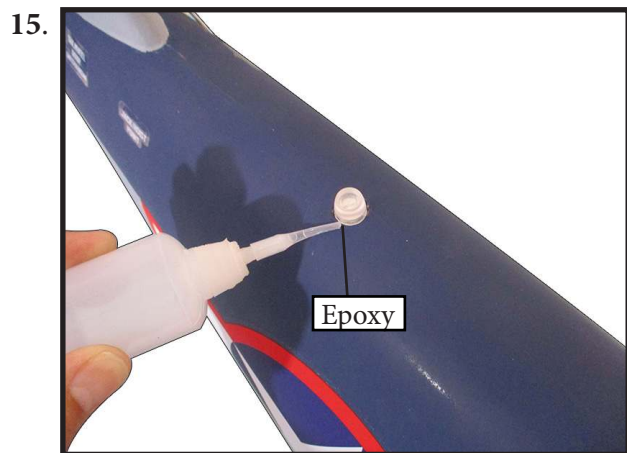
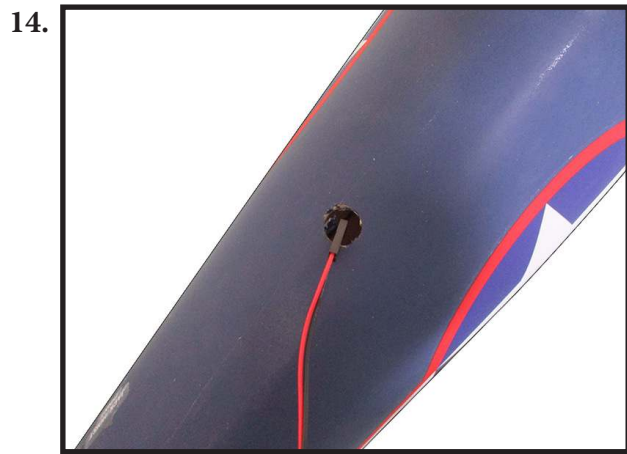

INSTALL ELEVATOR CONTROL HORN

Install the elevator control horn using the same method as same as the flap control horns.

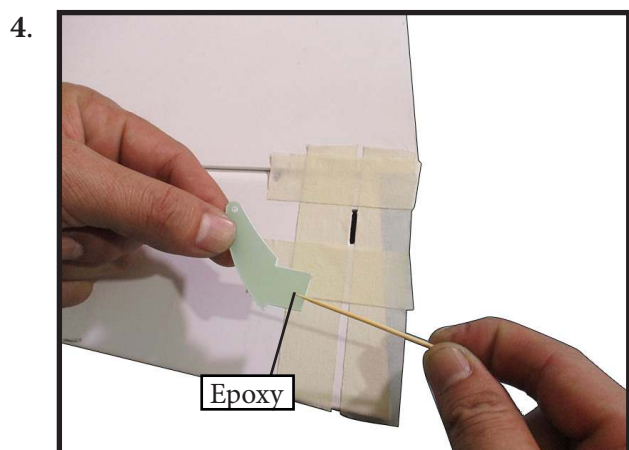
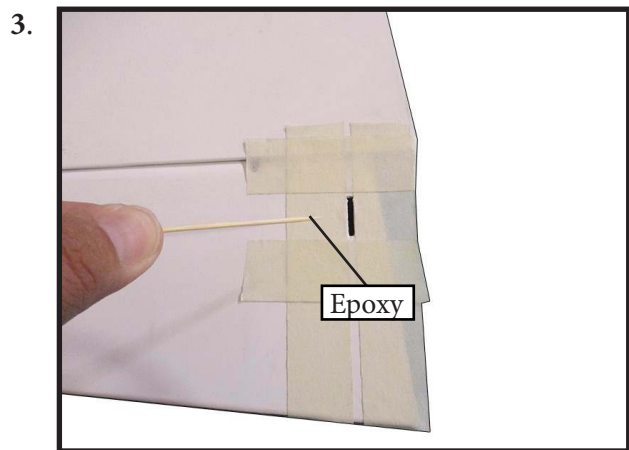
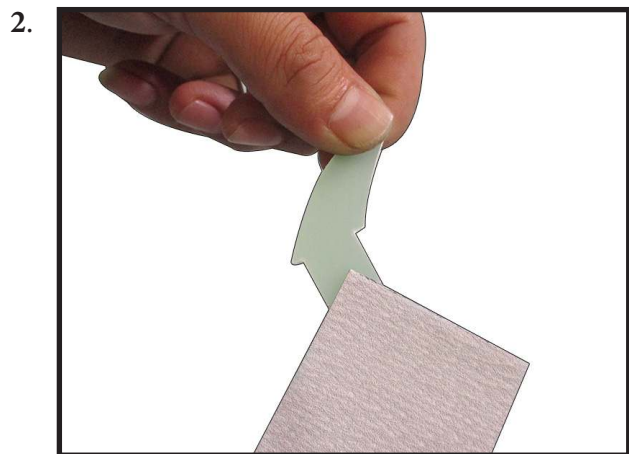
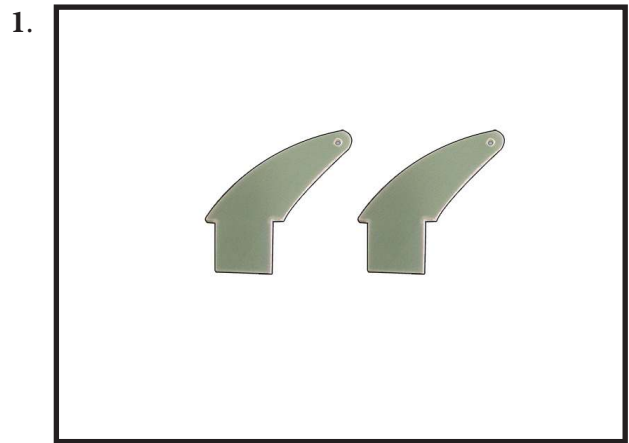

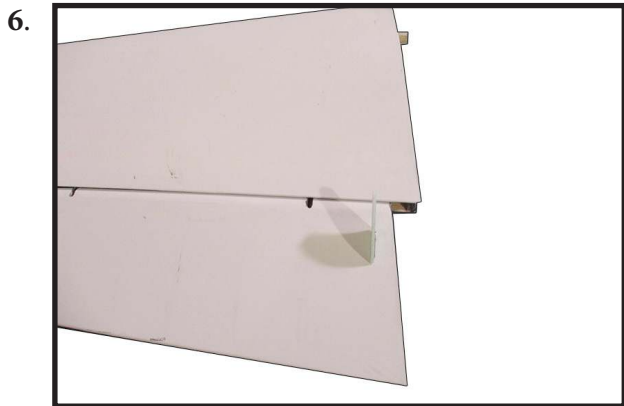
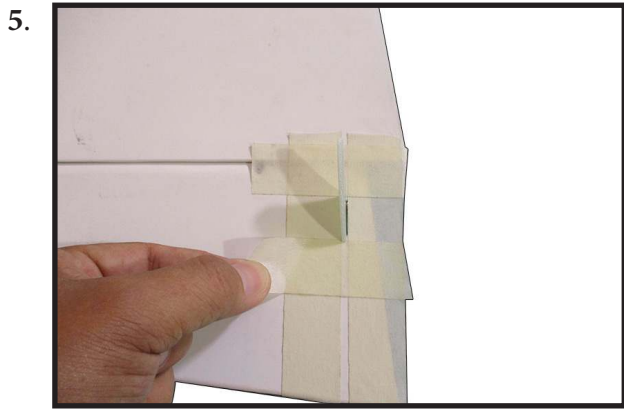

INSTALL RUDDER CONTROL HORN

Install the rudder control horn using the same method as the aileron control horns.

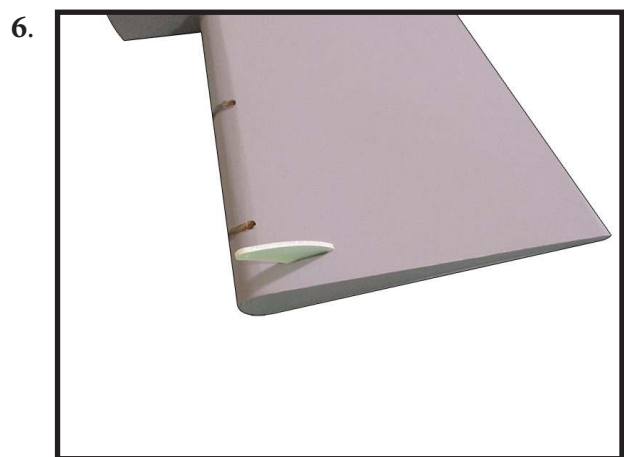
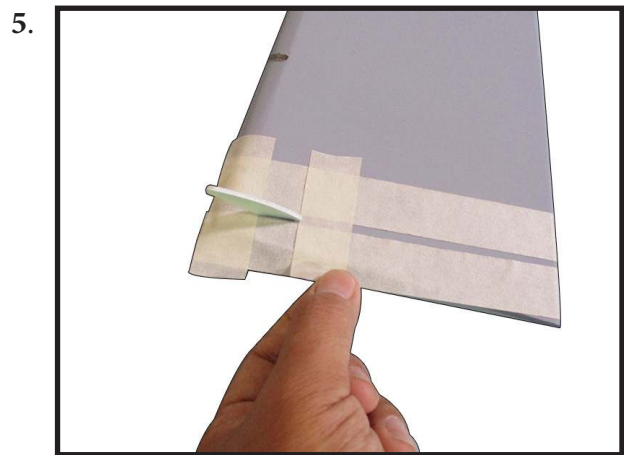
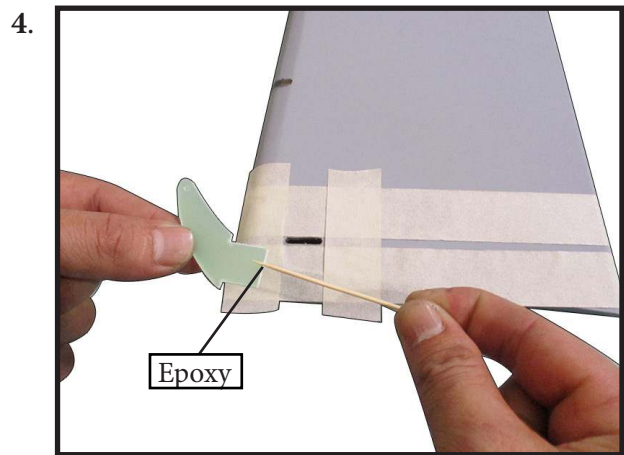
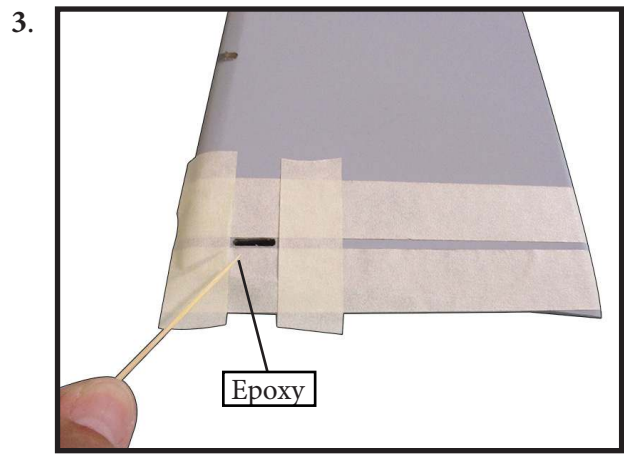
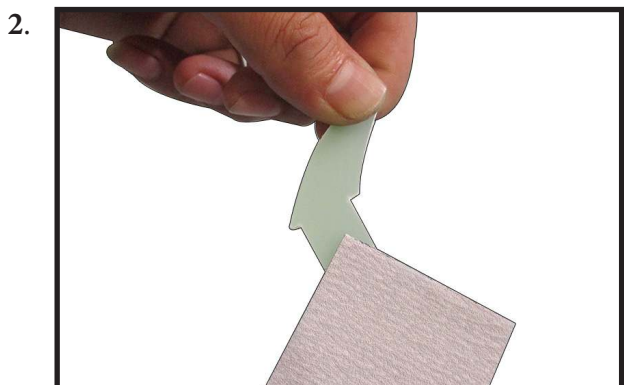
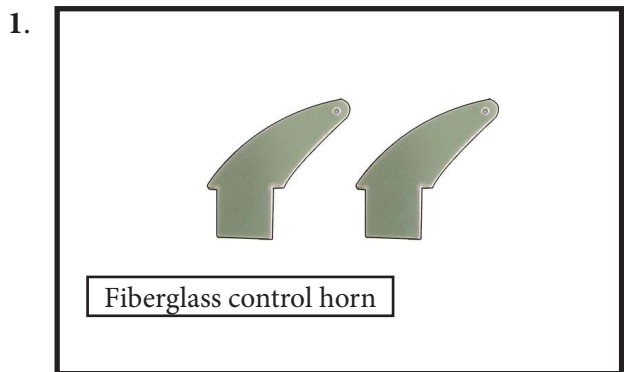

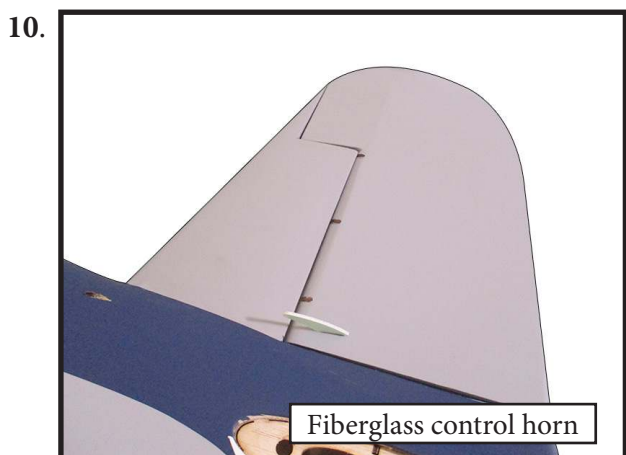
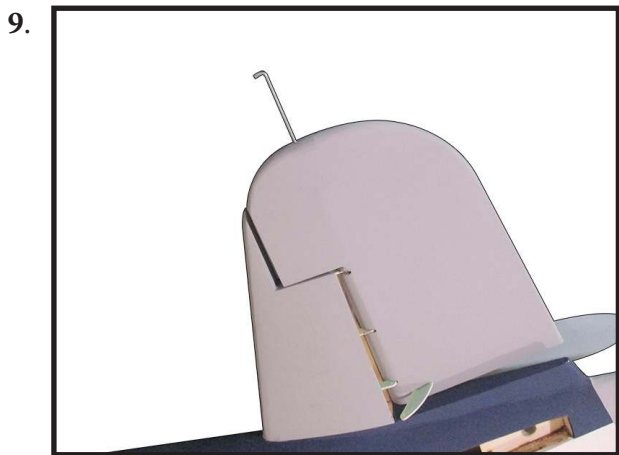
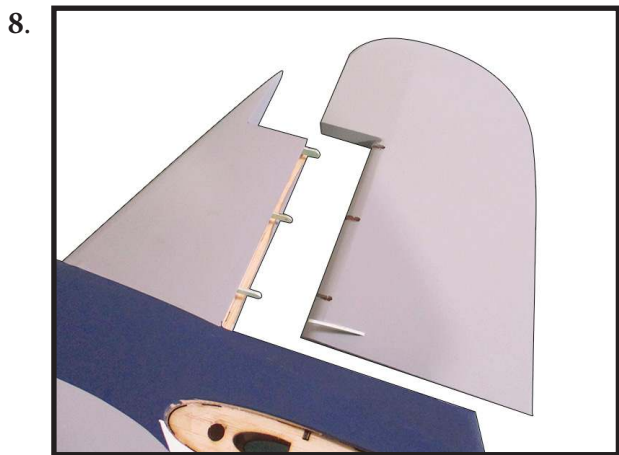
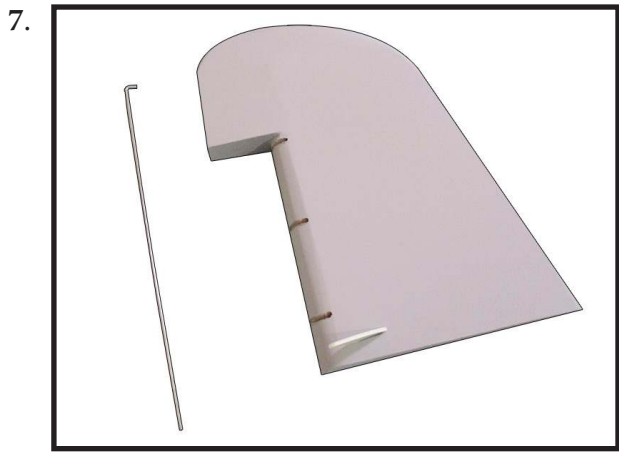

INSTALLING HORIZONTAL STABILIZER

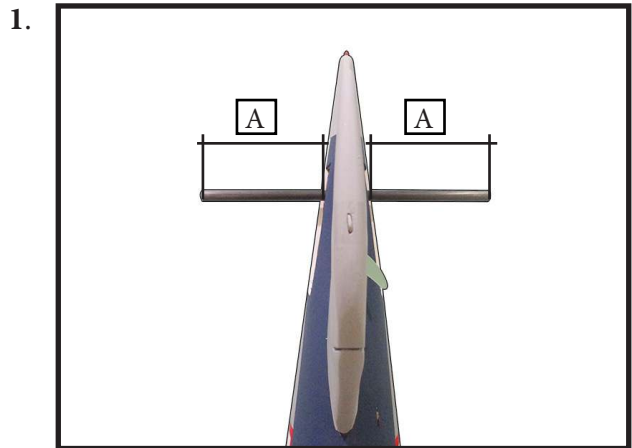

Use Epoxy to glue the Horizontal Stabilizer to the fuselage.

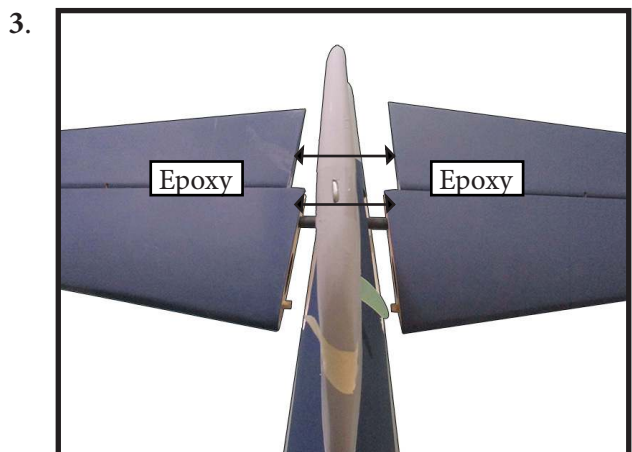
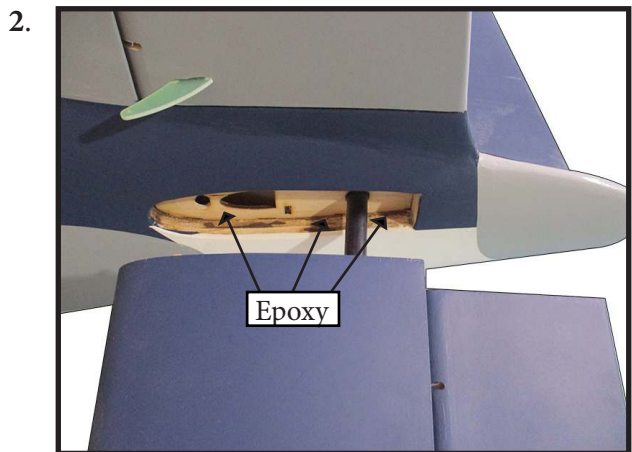

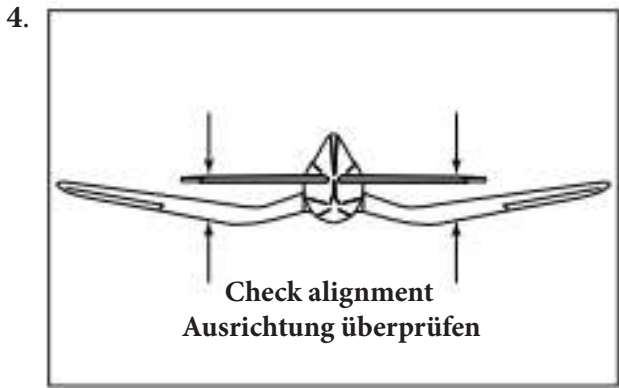

ELEVATOR PUSHROD HORN INSTALLATION

Install the elevator control horn using the same method as with the aileron control horns.

Position the elevator control horns on both side of the elevator.

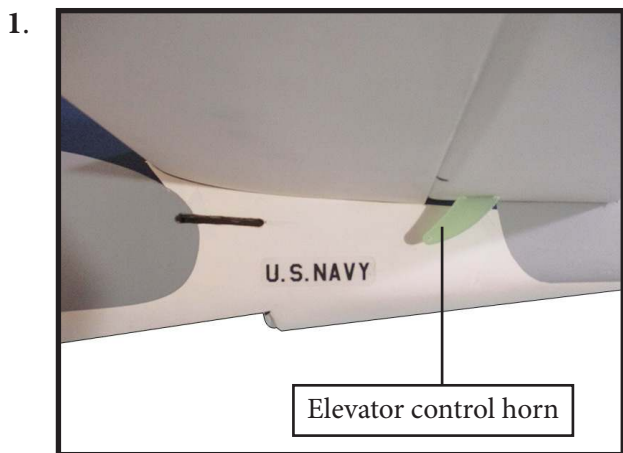

Thread one clevis and M3 lock nut on to each elevator control rod. Thread the horns on until they are flush with the ends of the control rods.

Assemble the elevator and rudder pushrods as shown in images below.

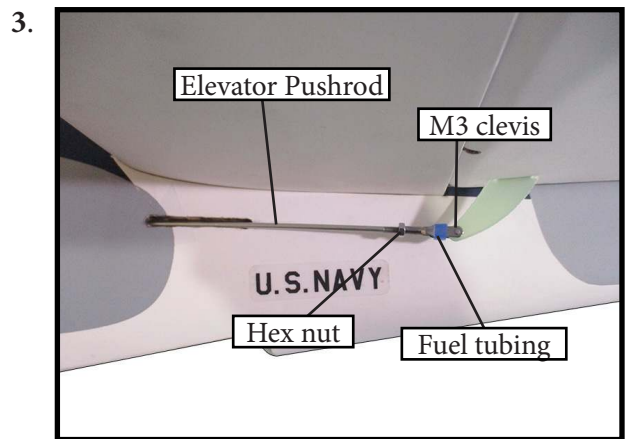
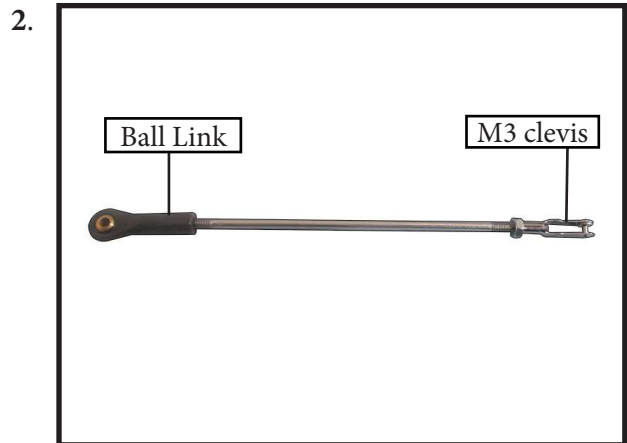
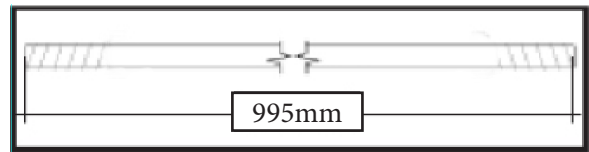

RUDDER CABLE INSTALLATION

Study images below to install pull-pull cable set.

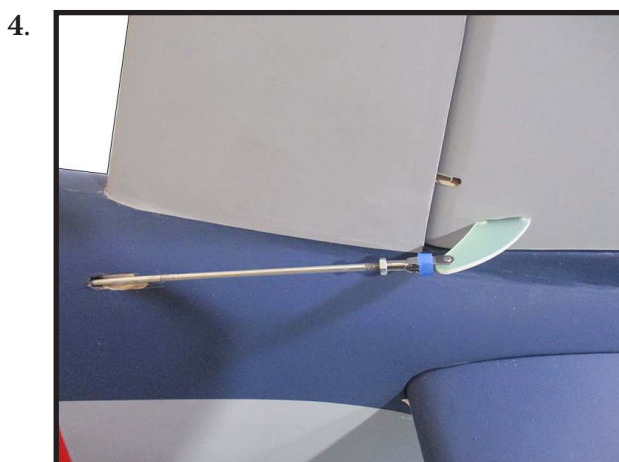
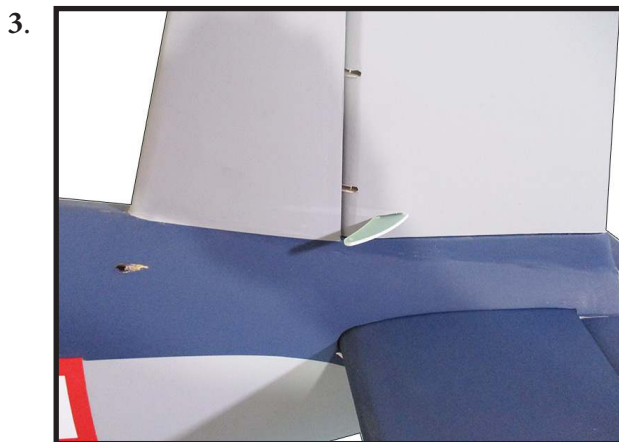
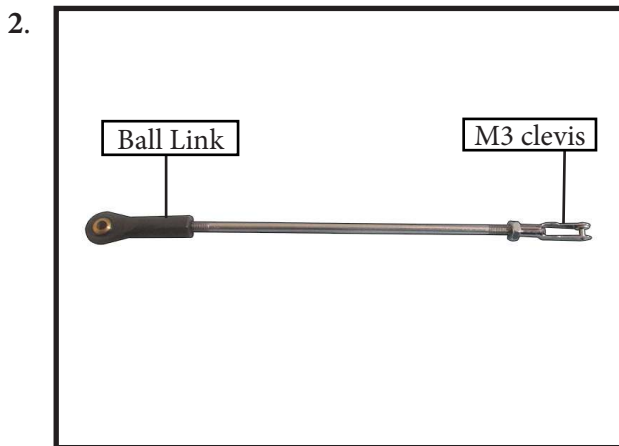
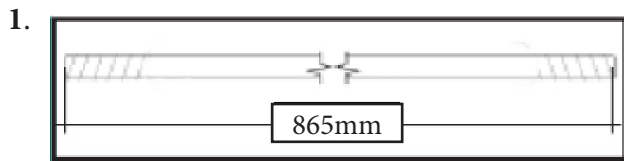

MOUNTING THE TAIL GEAR ROBERT

Gather tail gear components as shown below for installation.

Robert ELECTRIC TAIL GEAR RH OFFSET 160RWCE

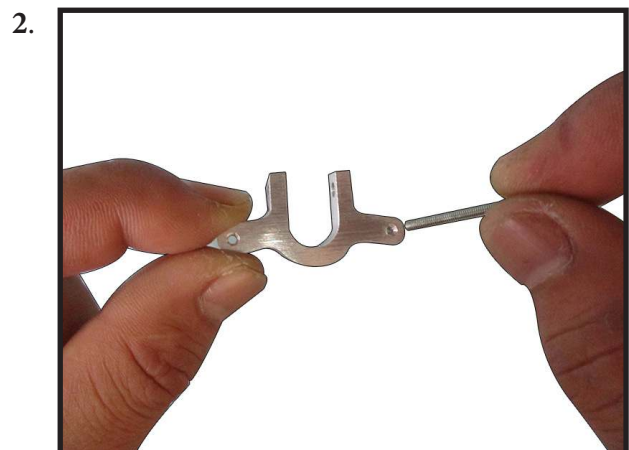

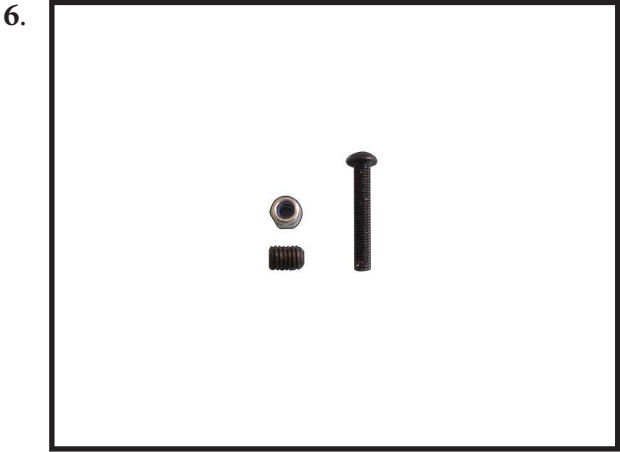
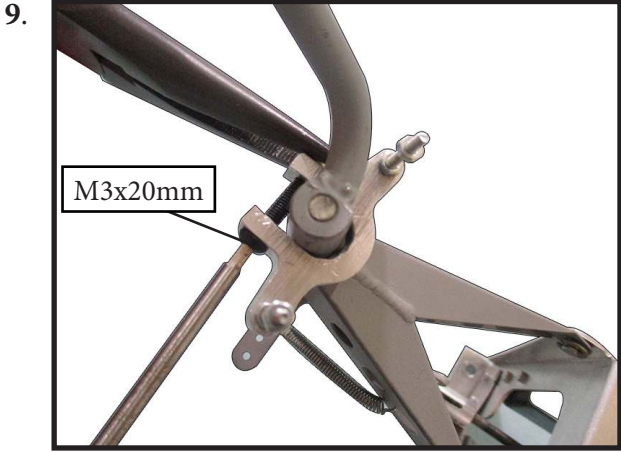
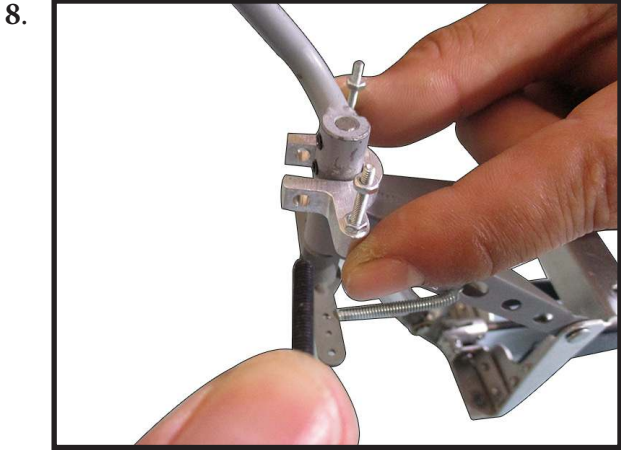
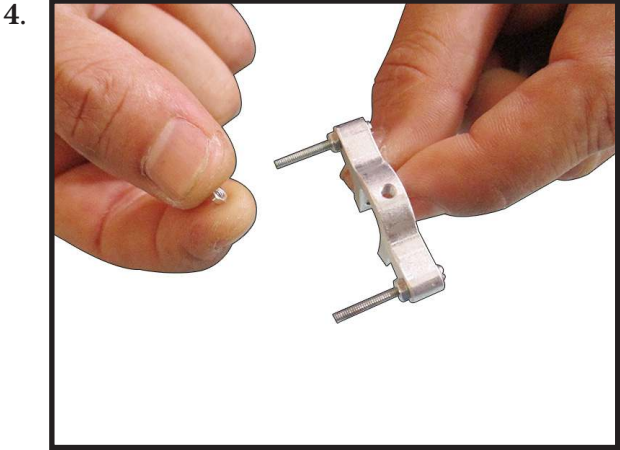

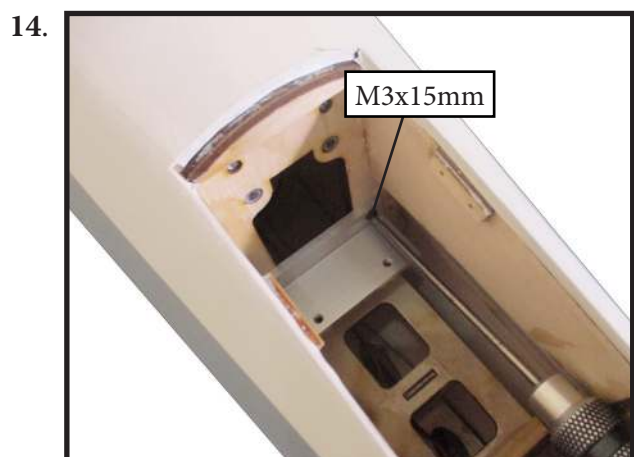
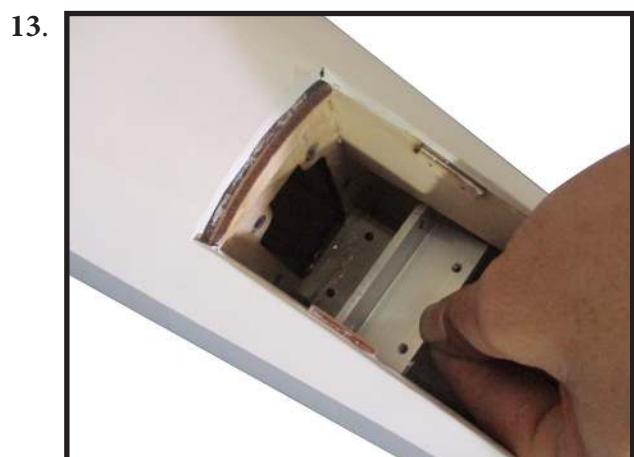
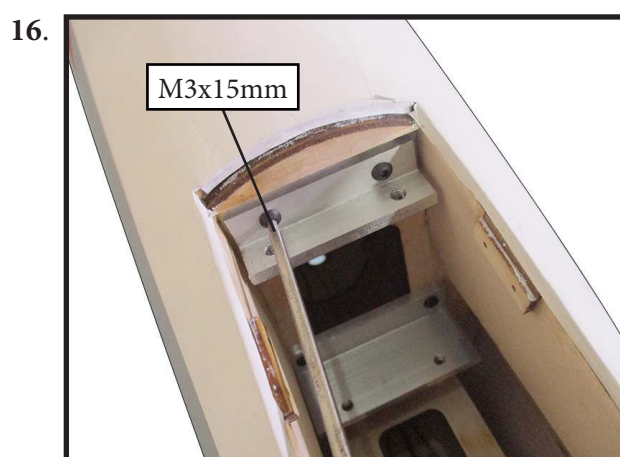
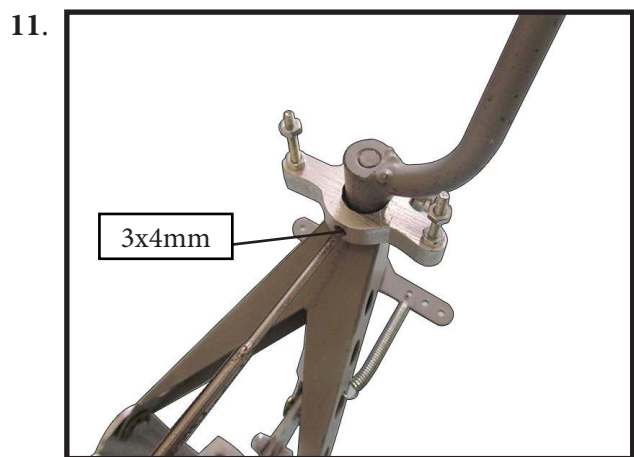

19.



23.

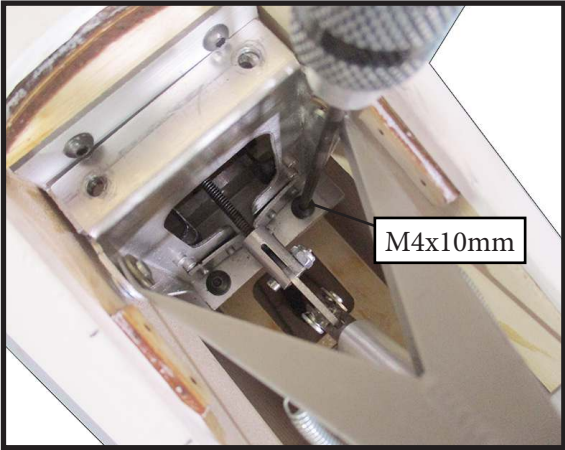

20.



24.



21.

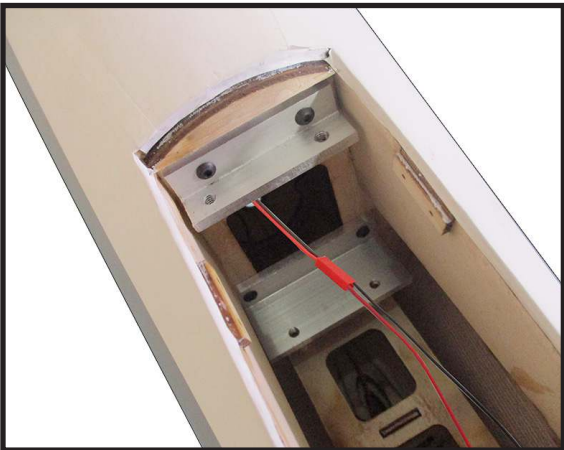

25.



22.

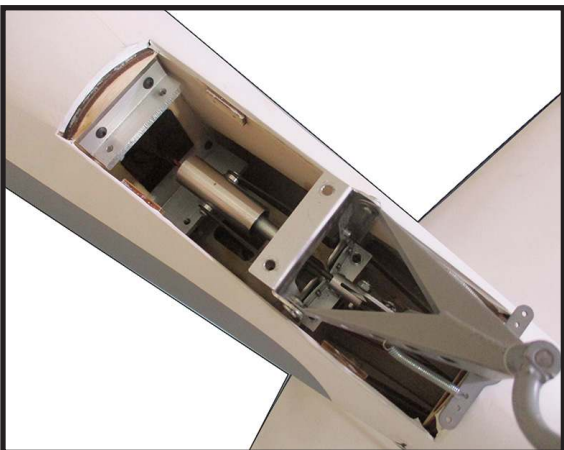

26.

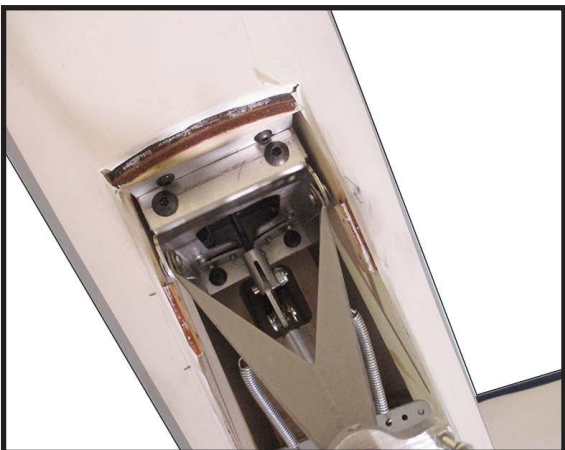

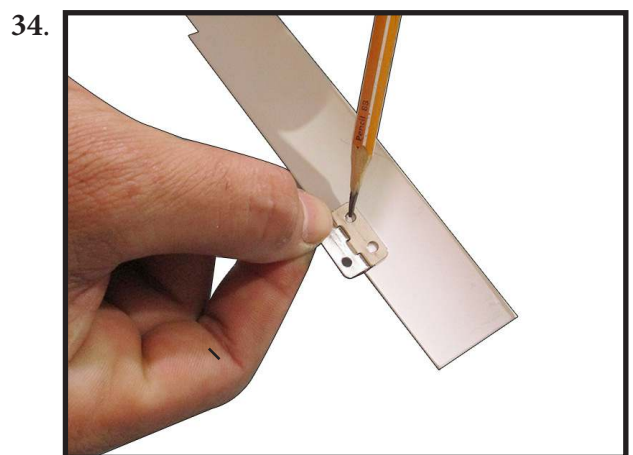
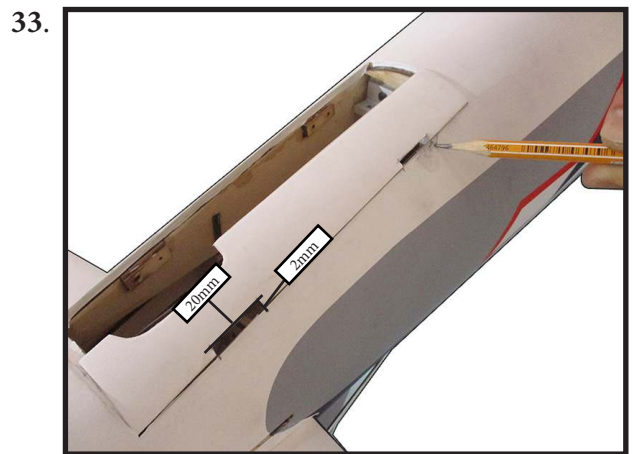
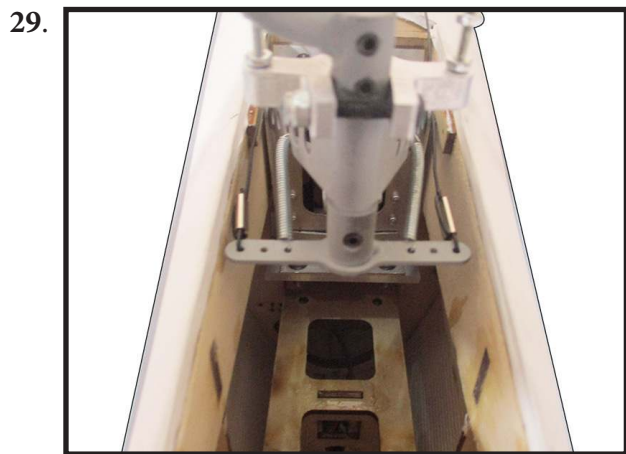
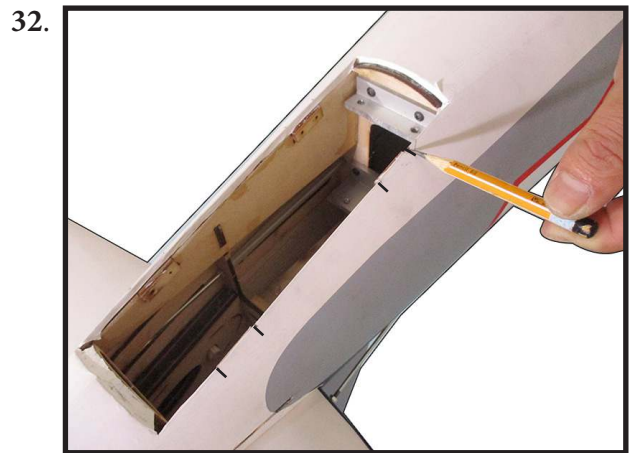
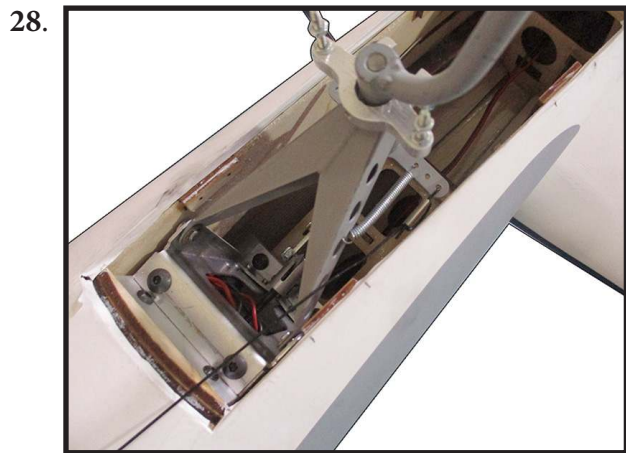
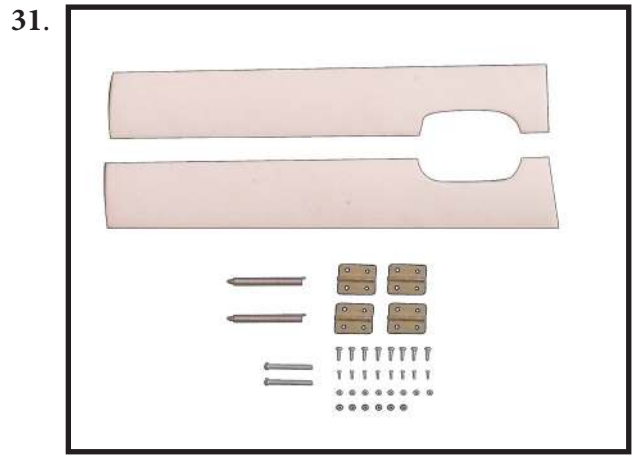
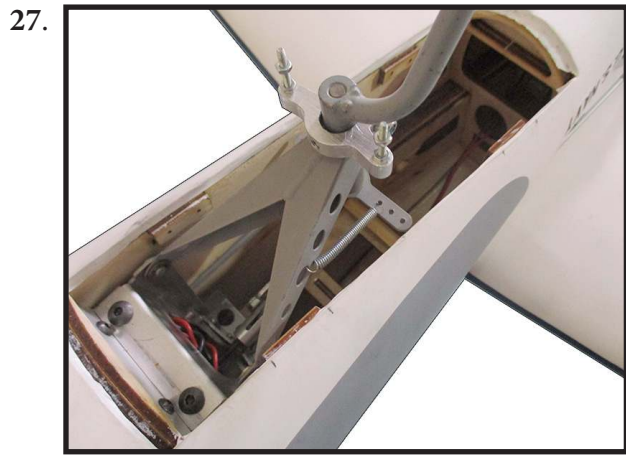

35.

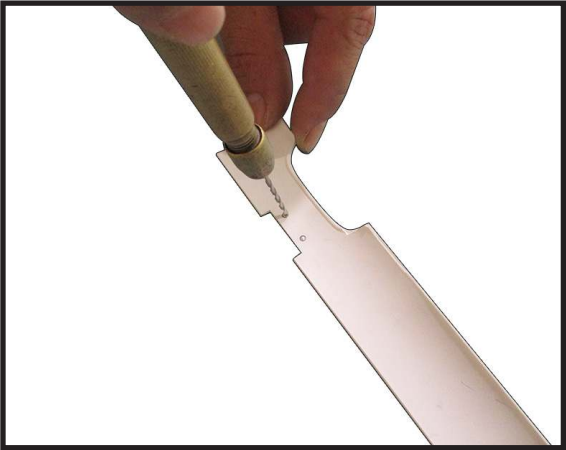

39.

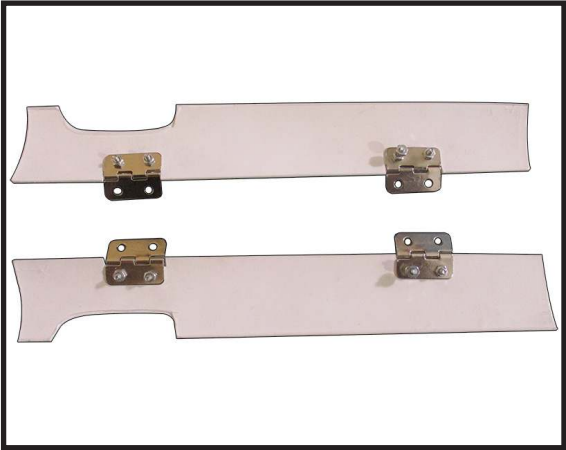

36.

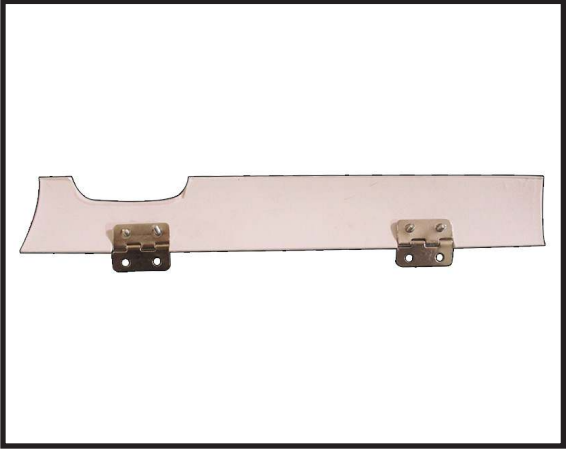

40.



37.

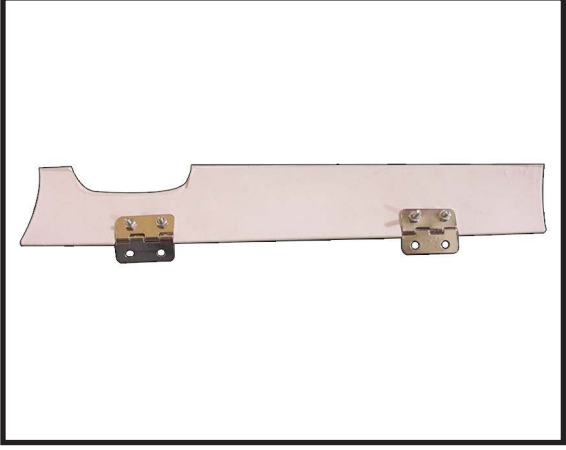

41.



38.



42.



43.

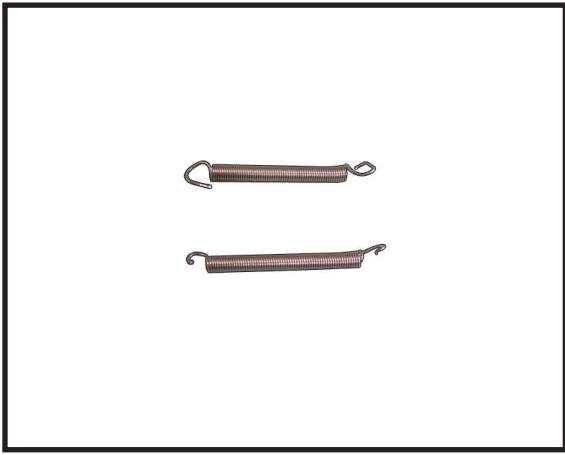

47.

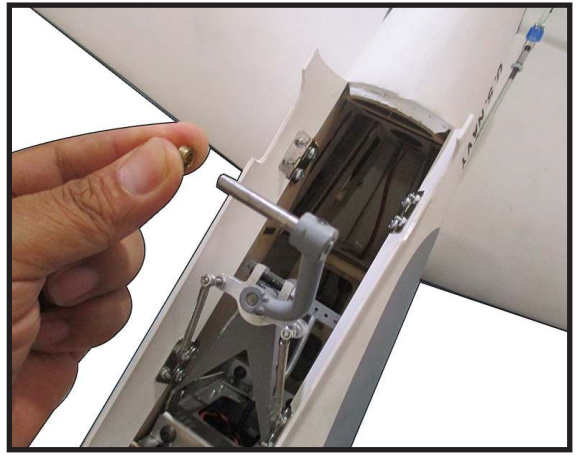

44.

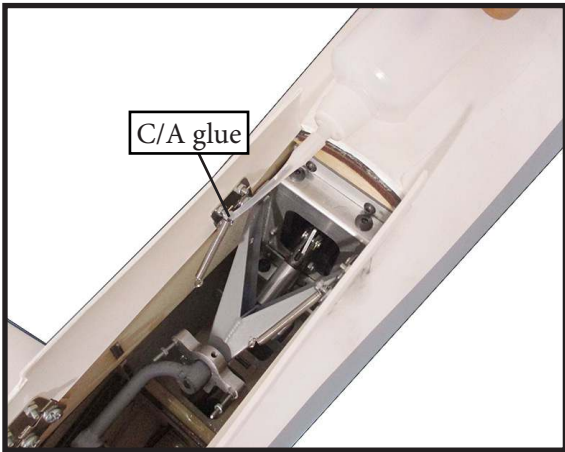

48.



45.

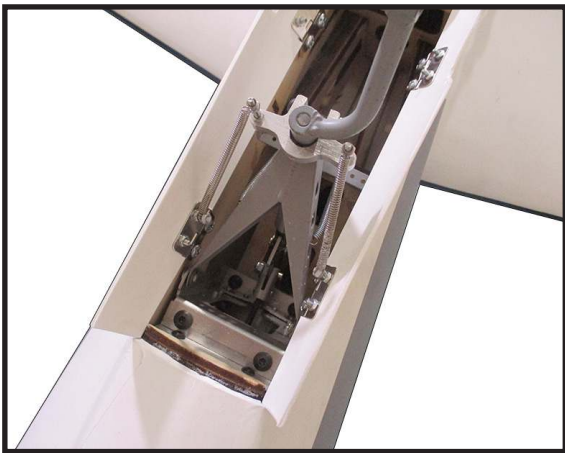

49.



46.



50.

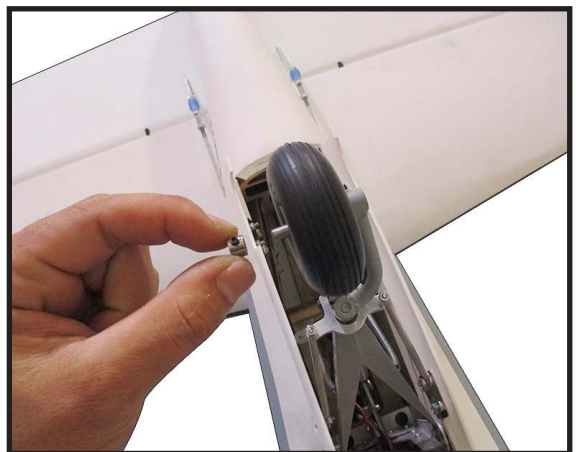

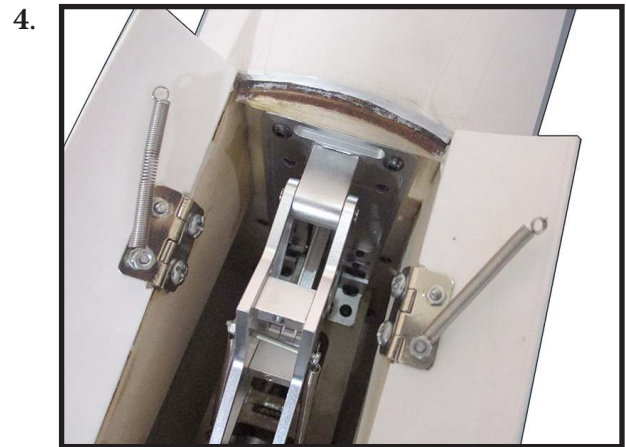
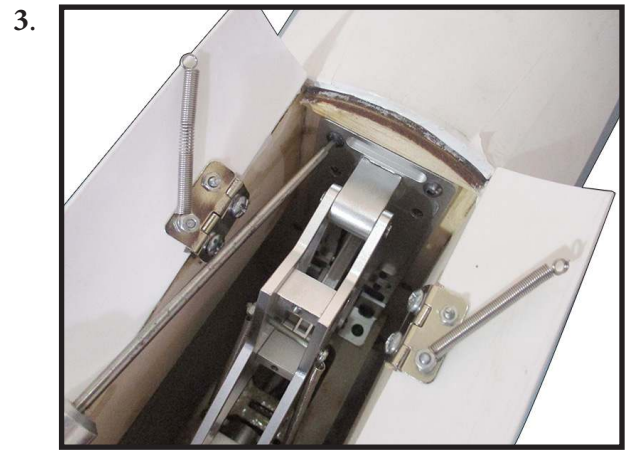

**MOUNTING THE TAIL GEAR
RETRACTABLE**

Locate items necessary to install.

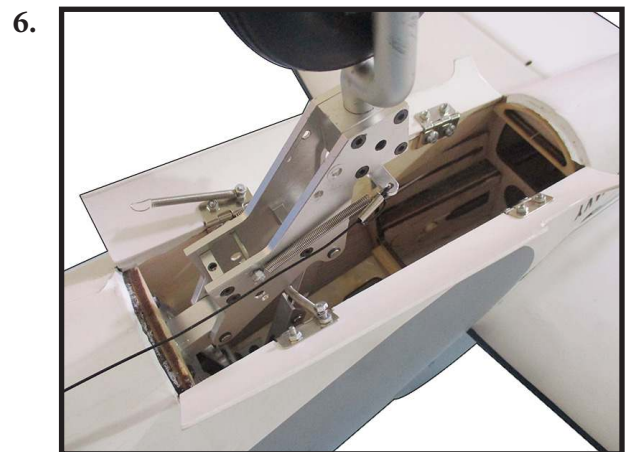
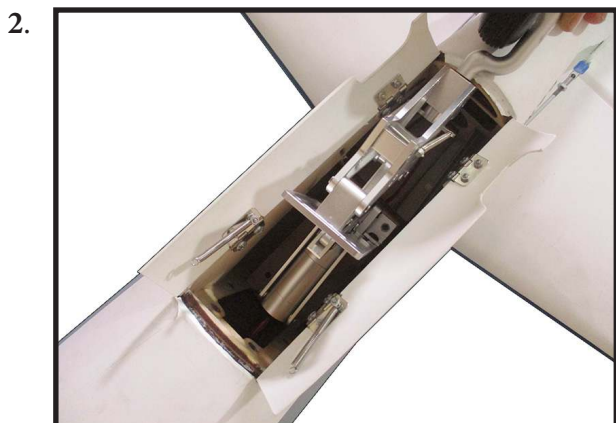
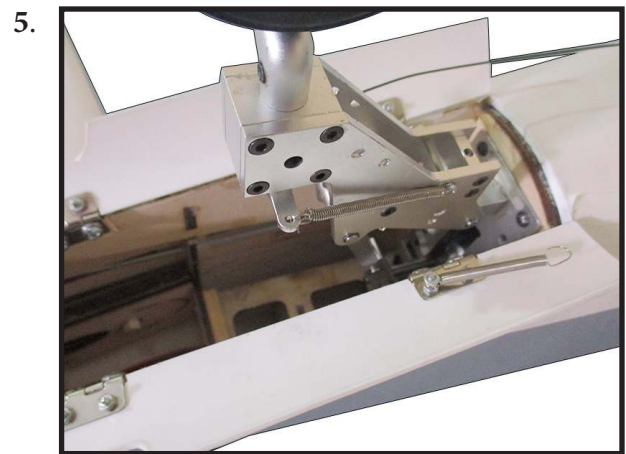
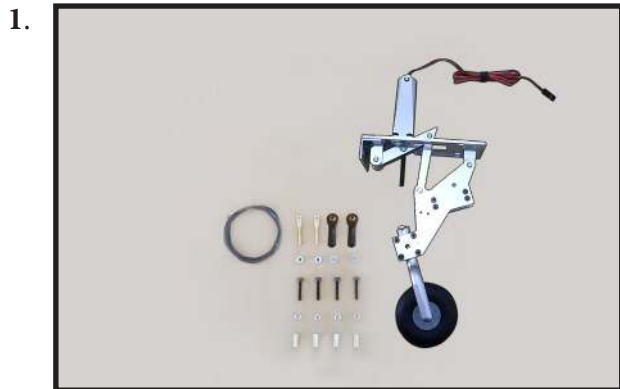

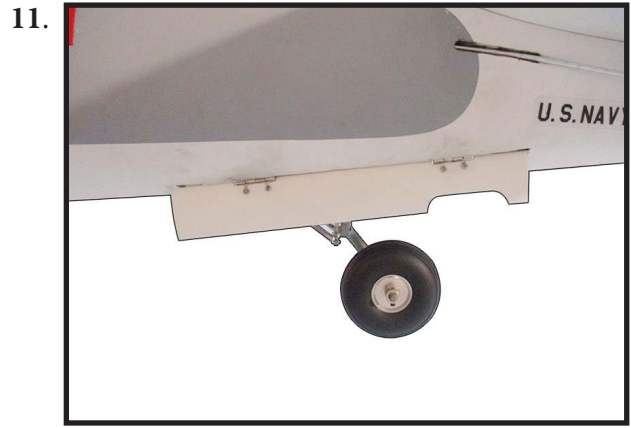
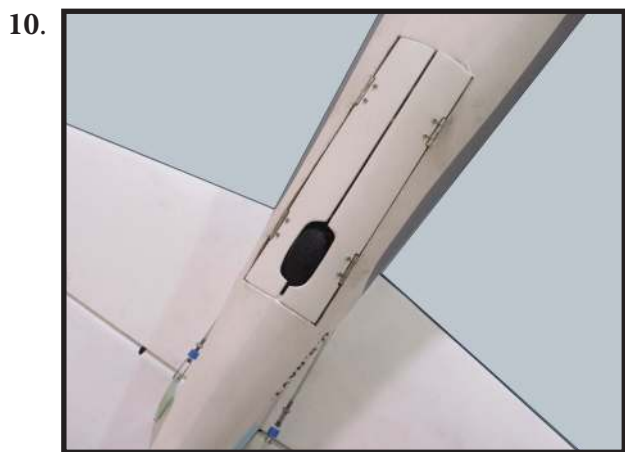
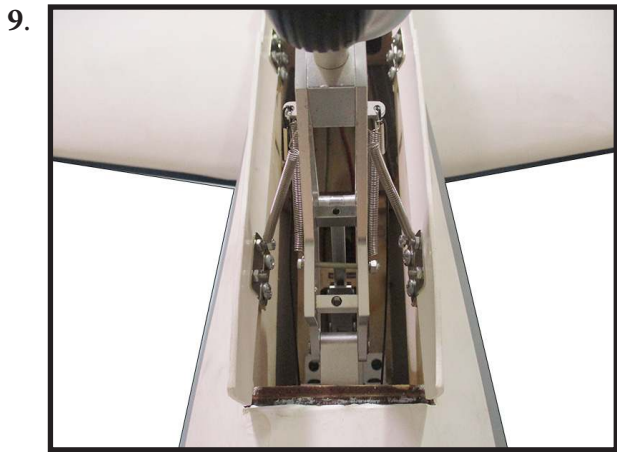
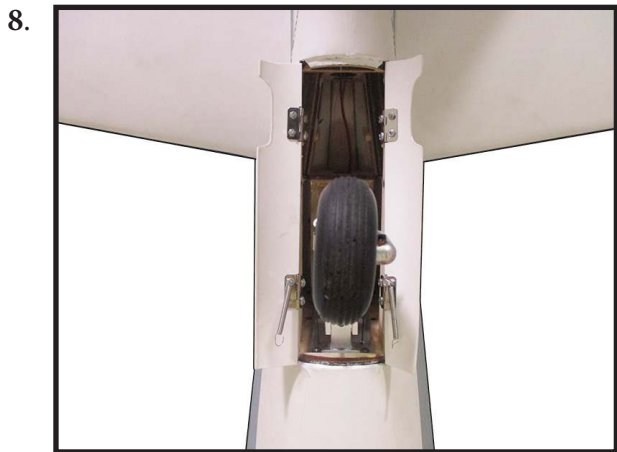
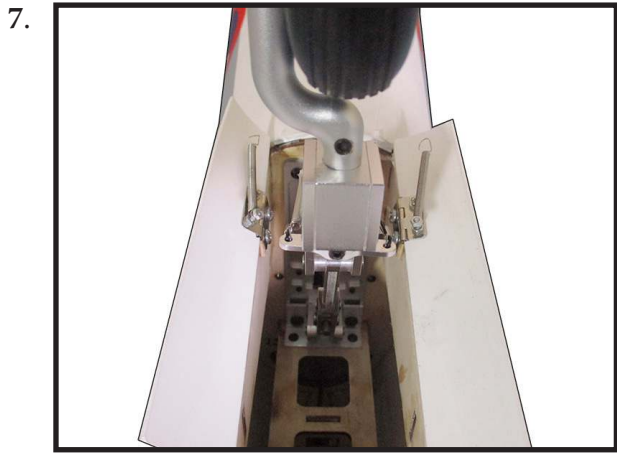

Install the plastic snap to the fuselage behind the tail underside, please see the picture below.



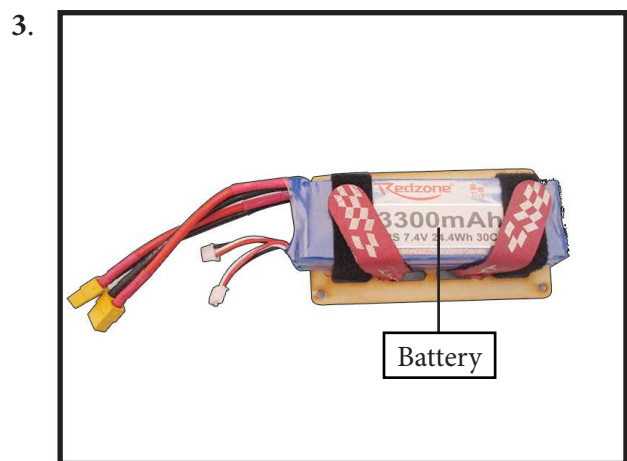
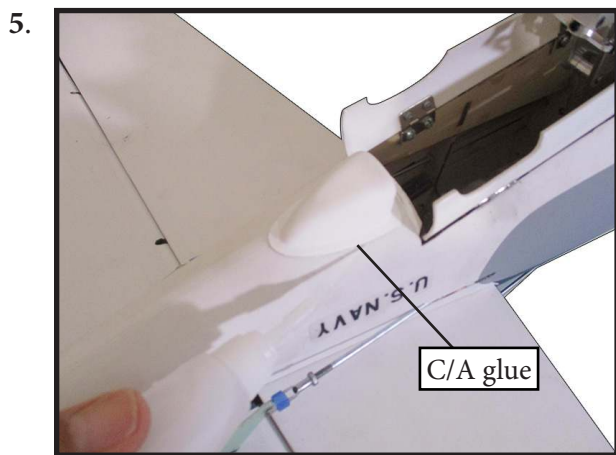
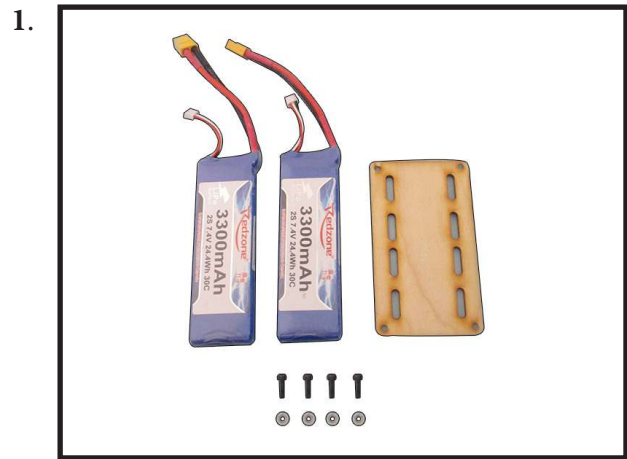
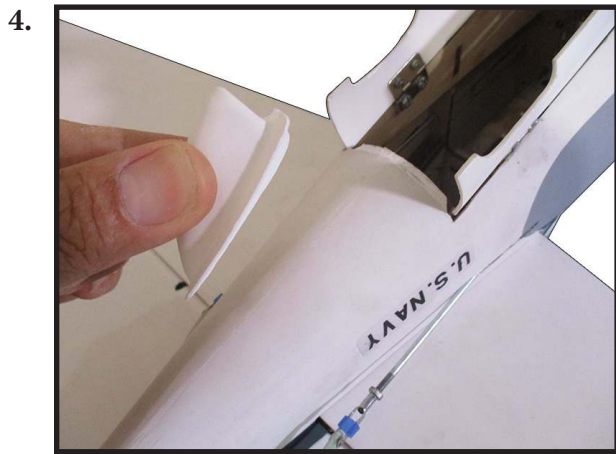

INSTALLING BATTERY - RECEIVER

Plug the servo leads and the switch lead into the receiver. Plug the battery pack lead into the switch also.

Wrap the receiver and battery pack in the protective foam rubber to protect them from vibration.

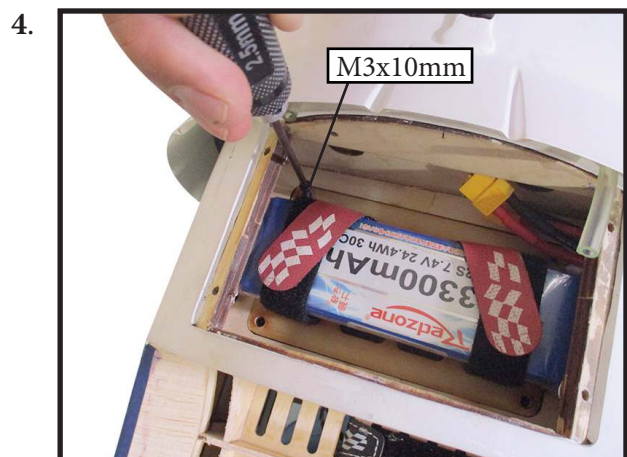

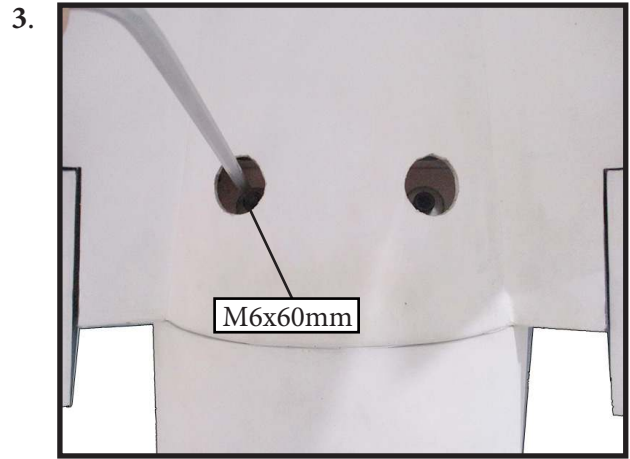
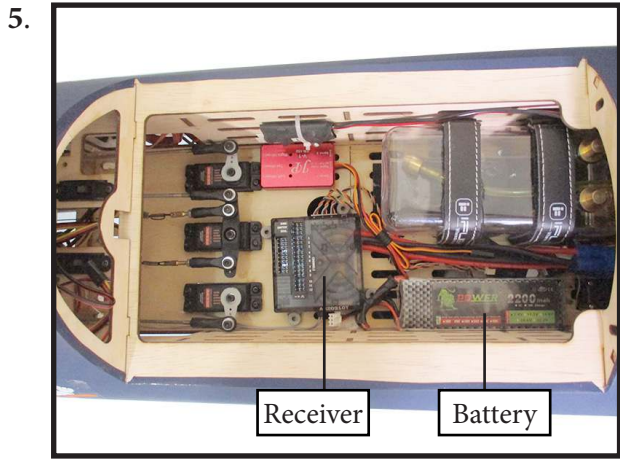

ATTACH WING TO FUSELAGE

Locate the (2) 6x60mm bolts and washers.

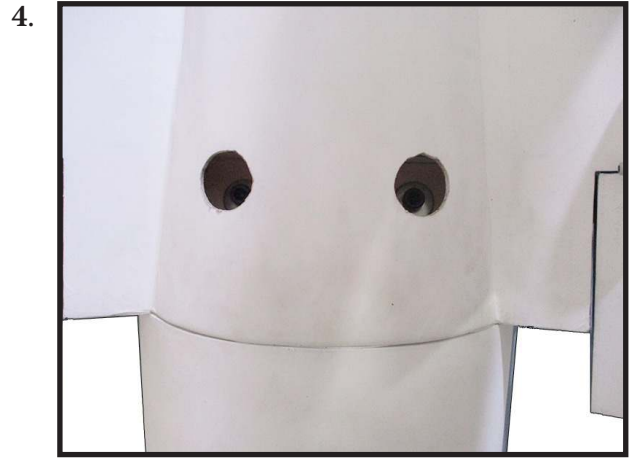

COCKPIT INSTALLATION

Locate all cockpit components as shown below.



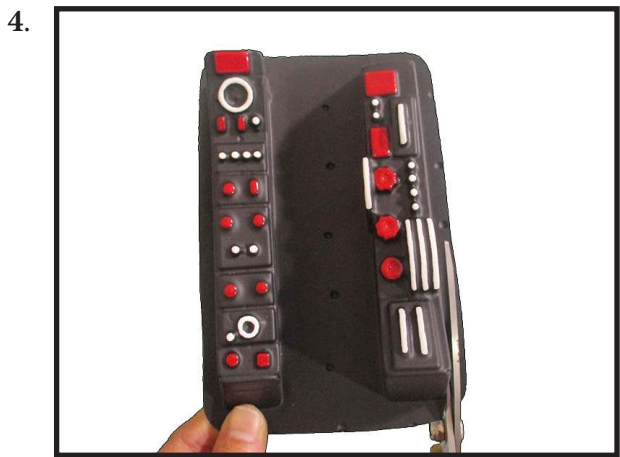
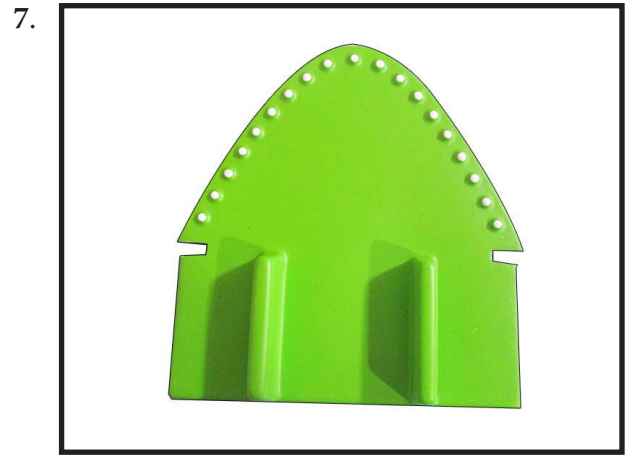
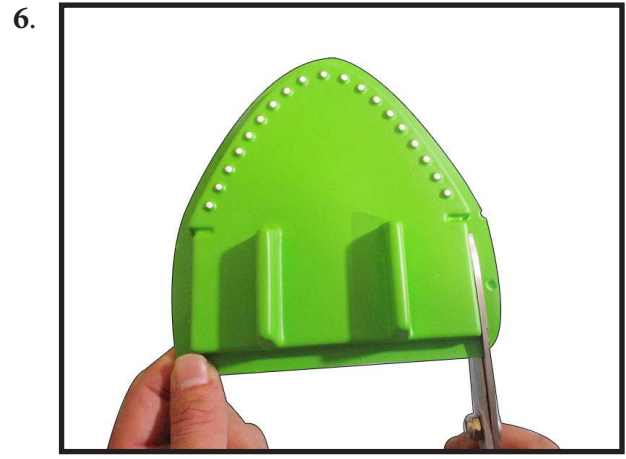

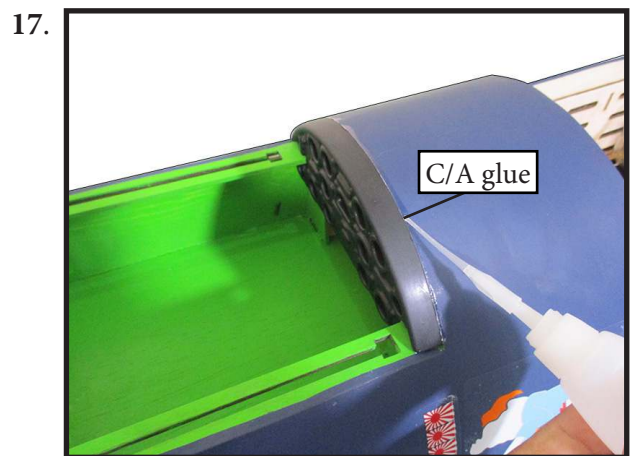
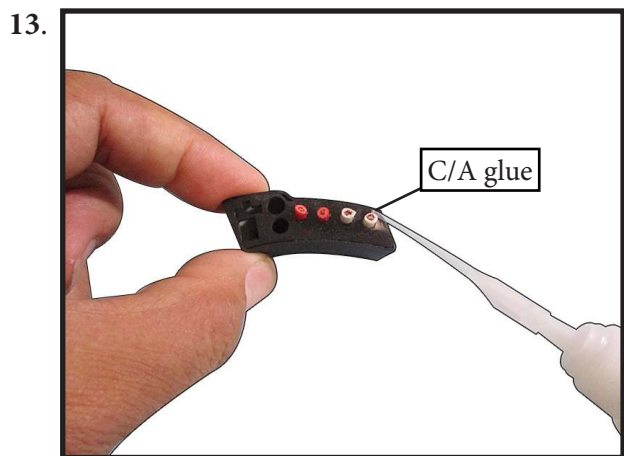
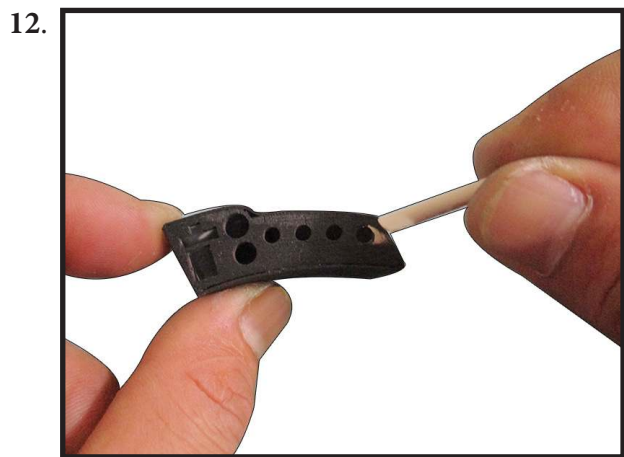
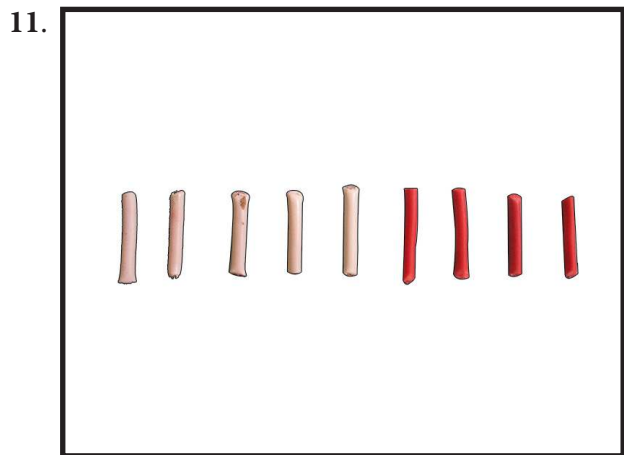
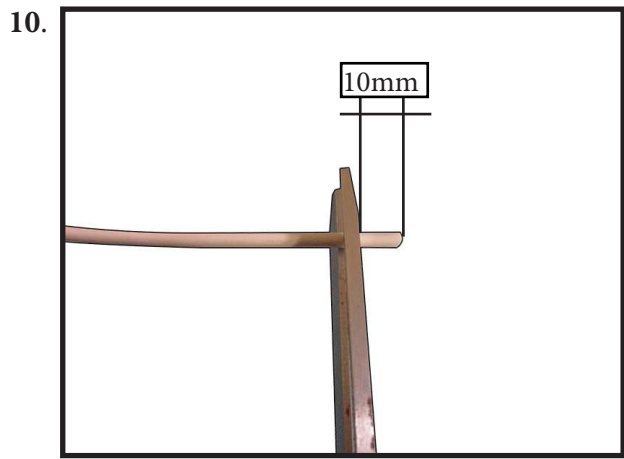

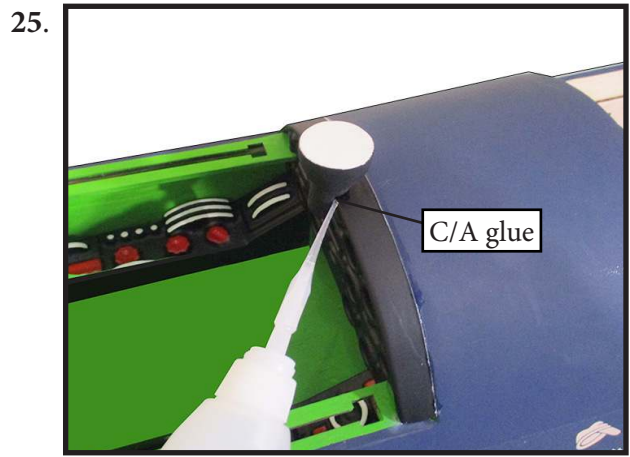
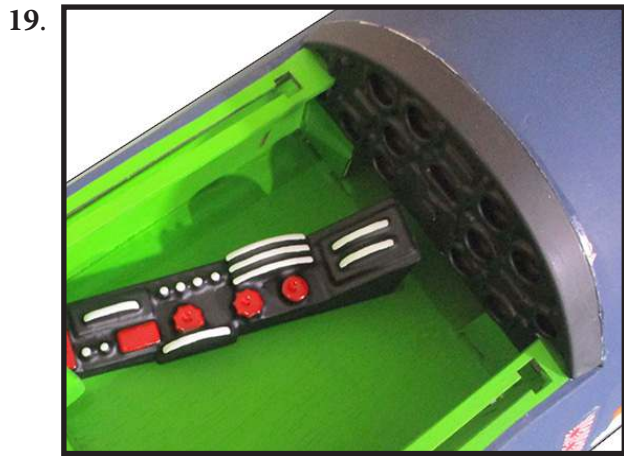
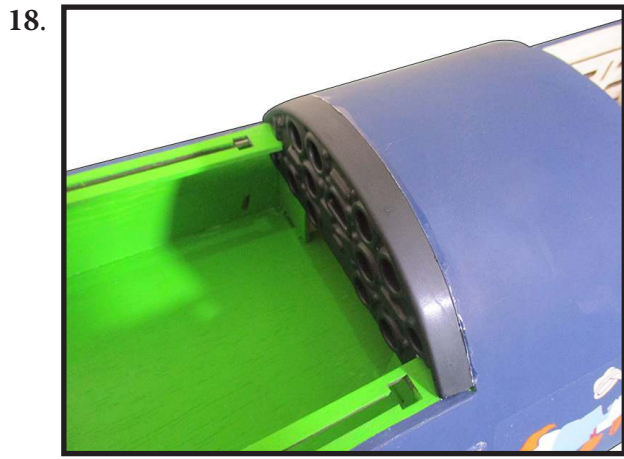

26.

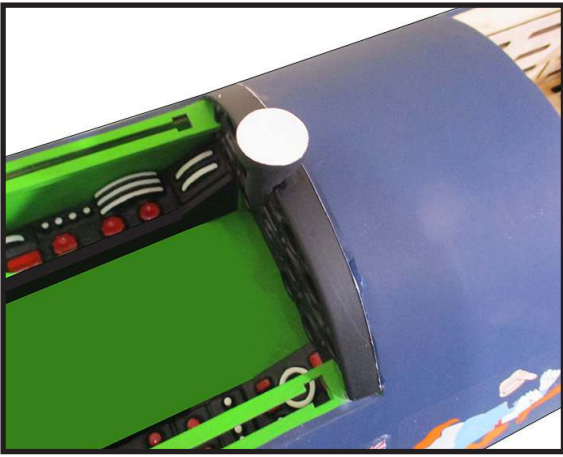

30.

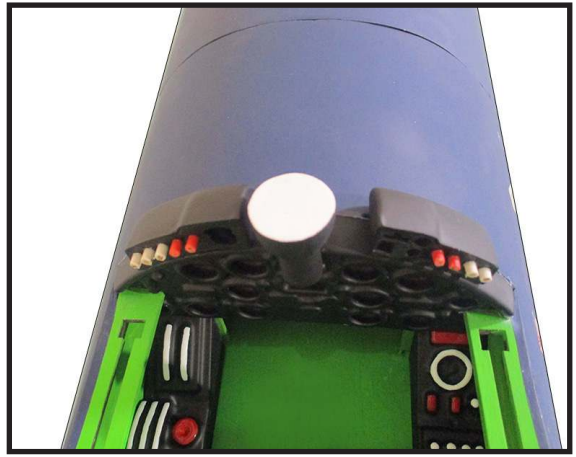

27.



31.

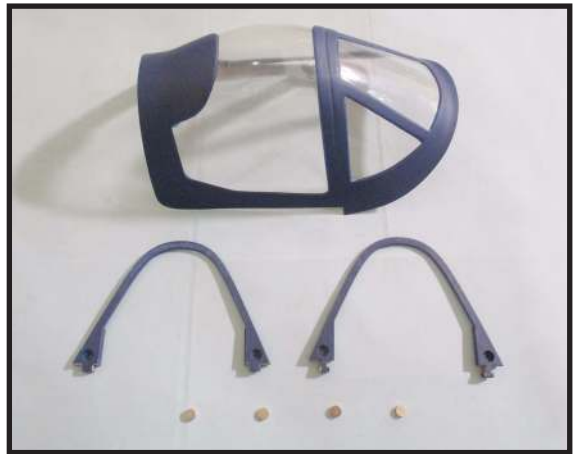

28.

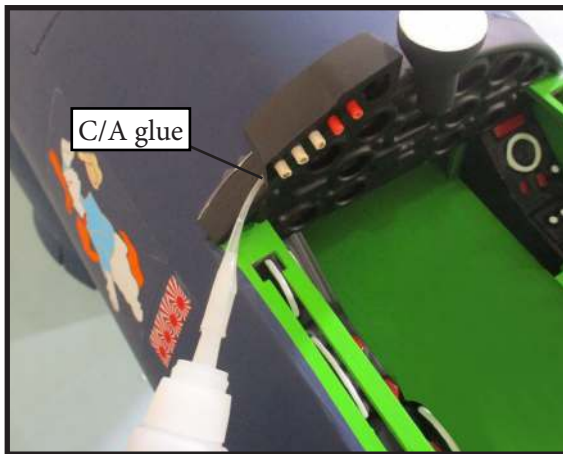

32.



29.



33.



34.

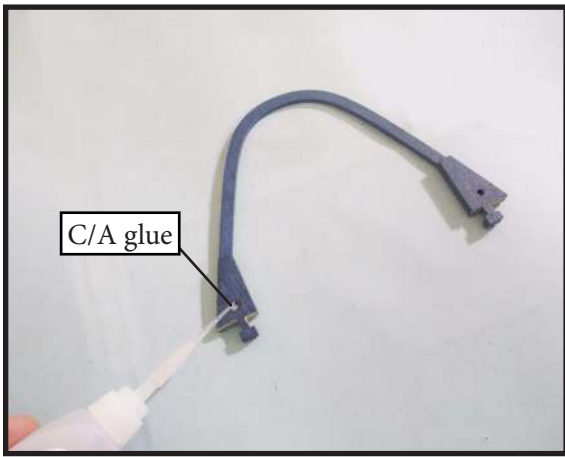

38.

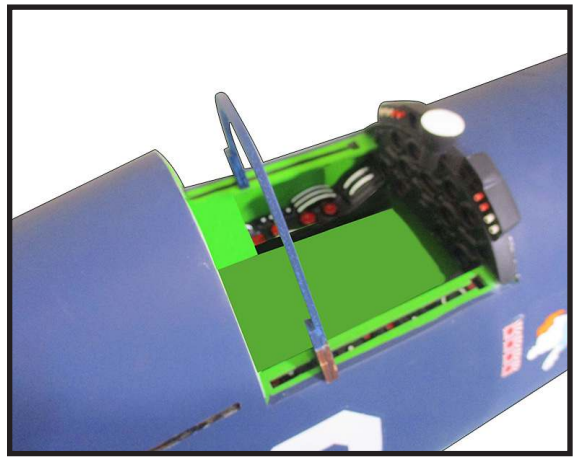

35.



39.

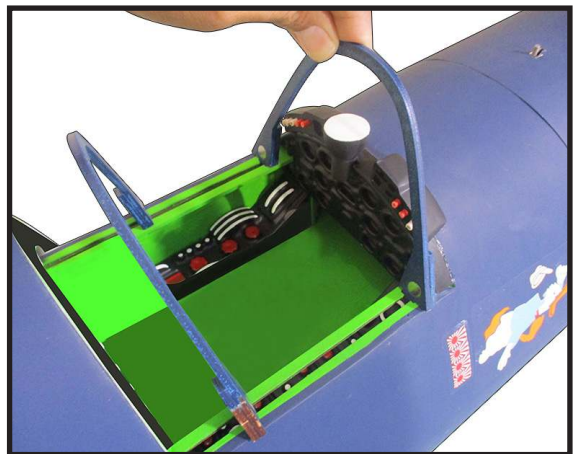

36.



40.

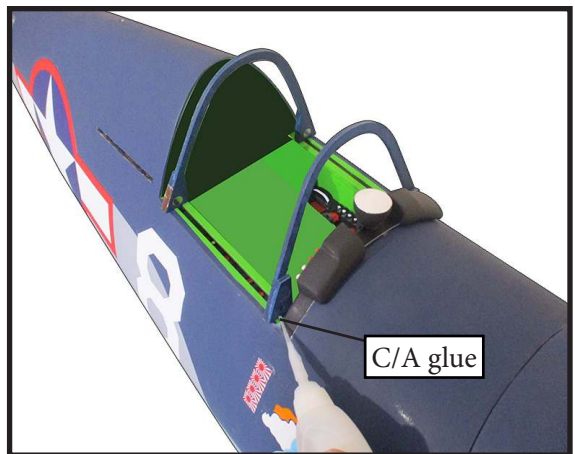

37.

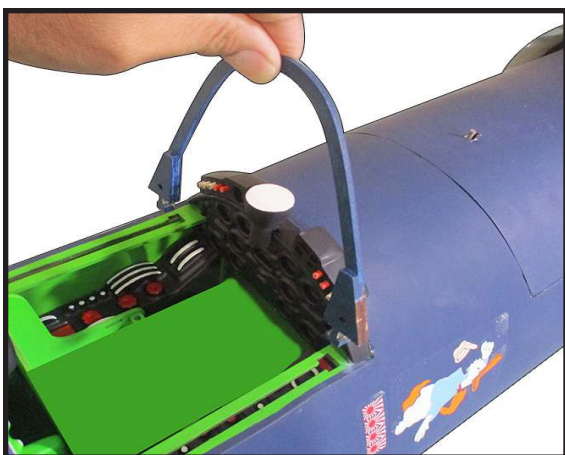

41.

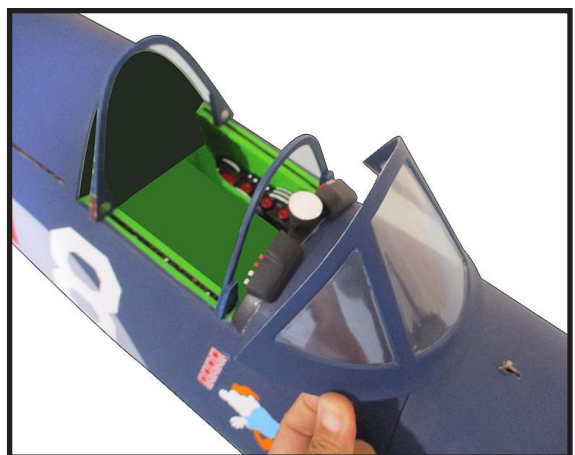

42.



46.

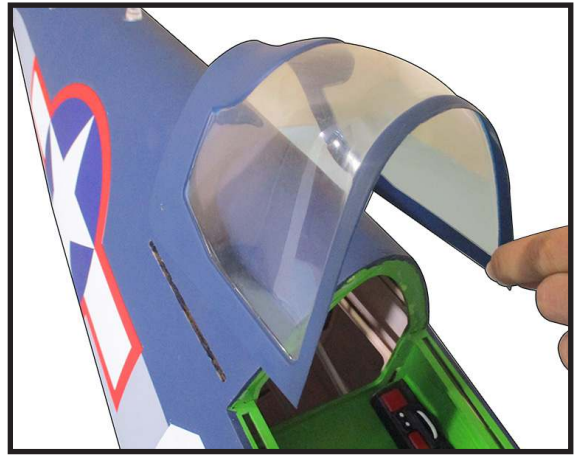

43.



47.



44.

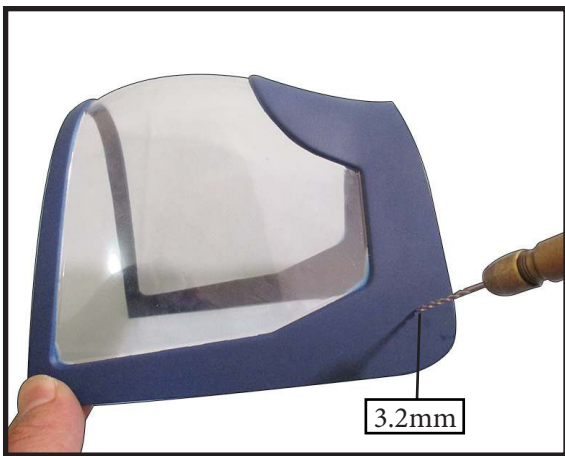

48.



45.



49.

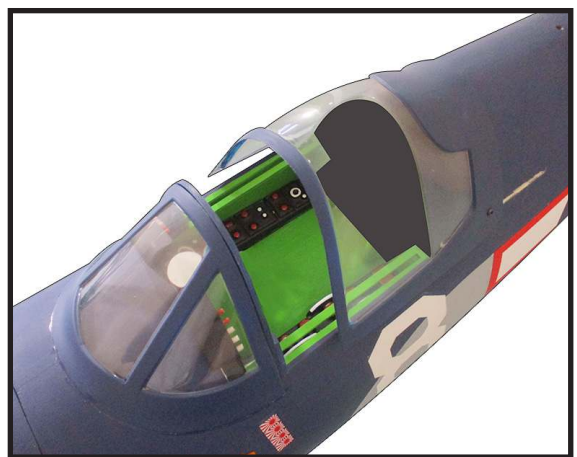

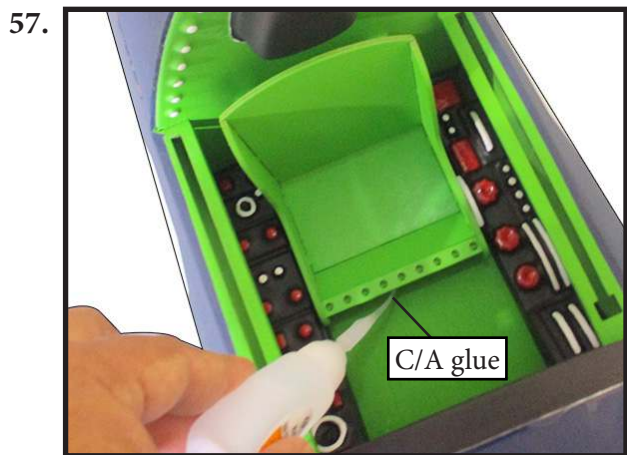
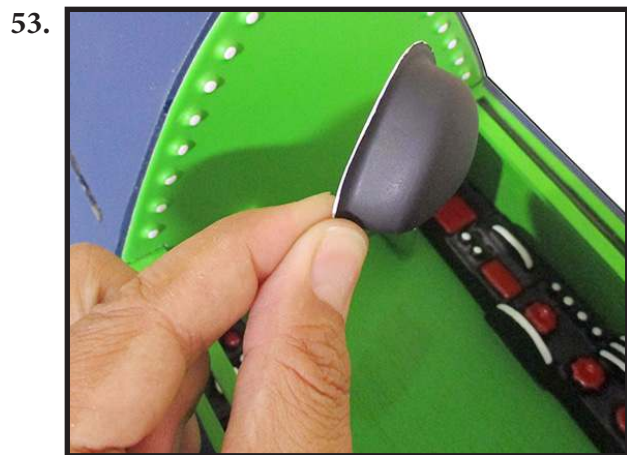
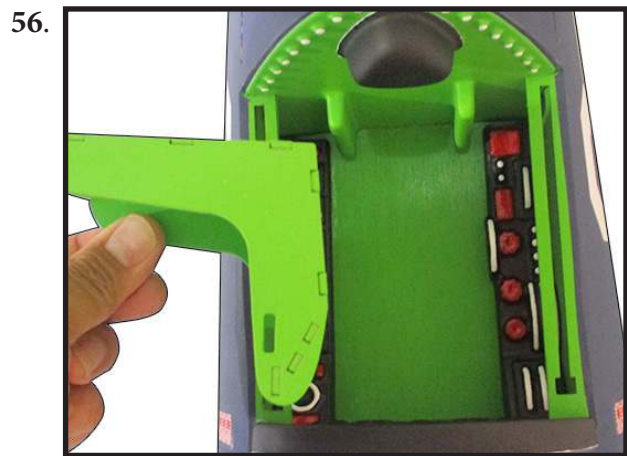
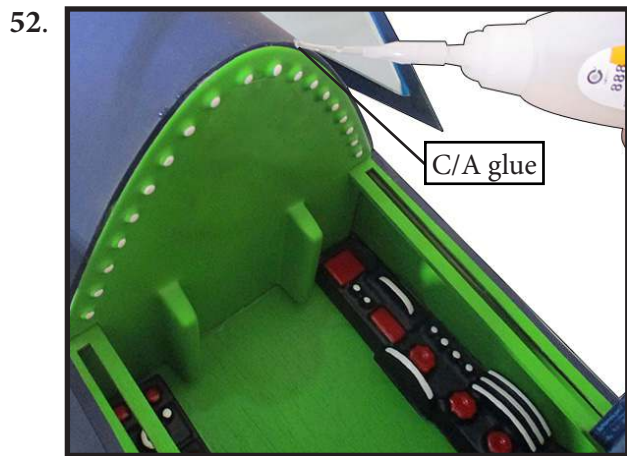
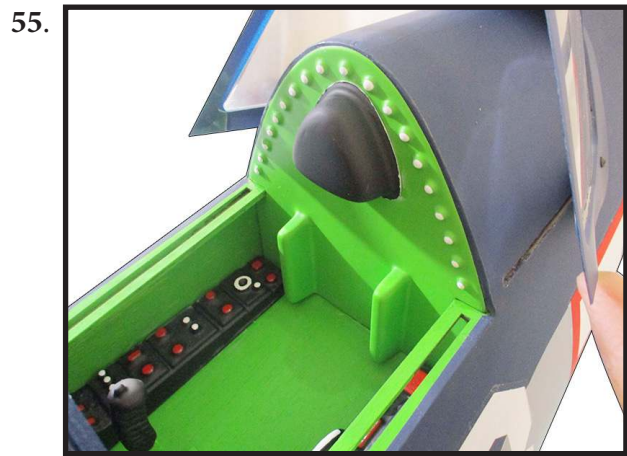
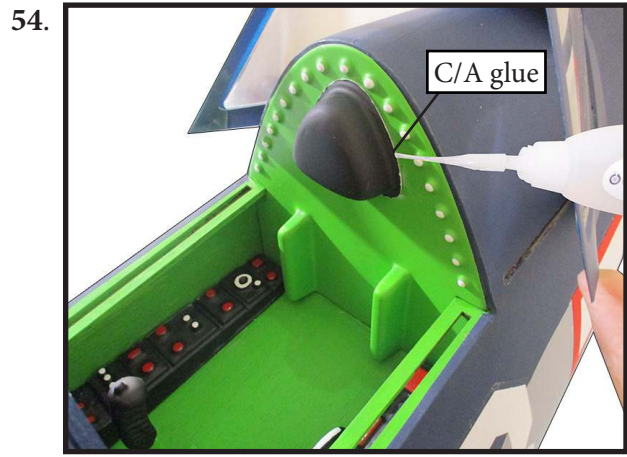
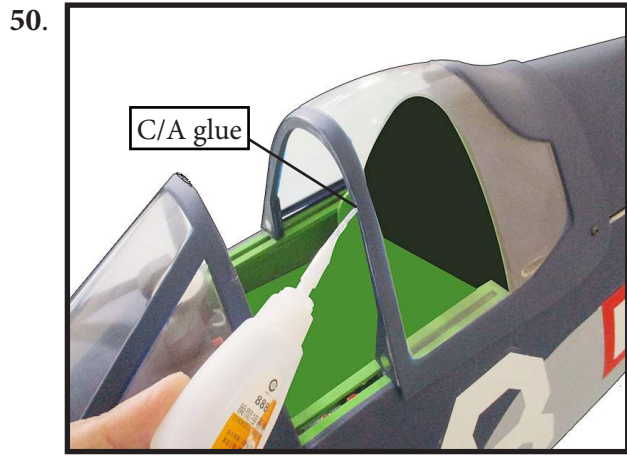

58.

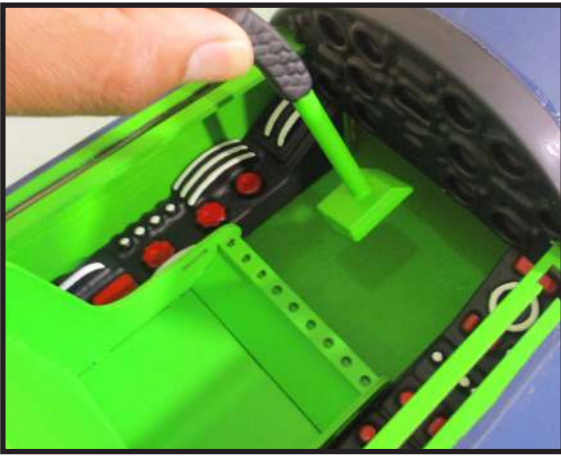

59.



60.

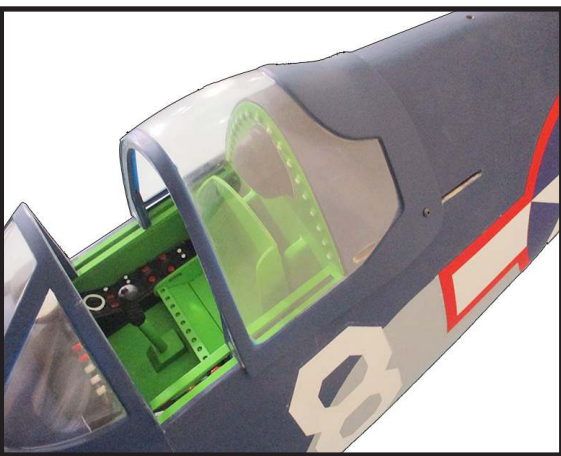

61.



INSTALL MAIN FUEL TANK COVER

Please study images below.

1.



2.

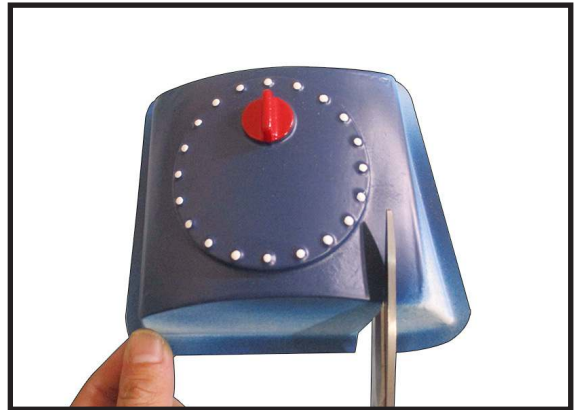

3.



4.



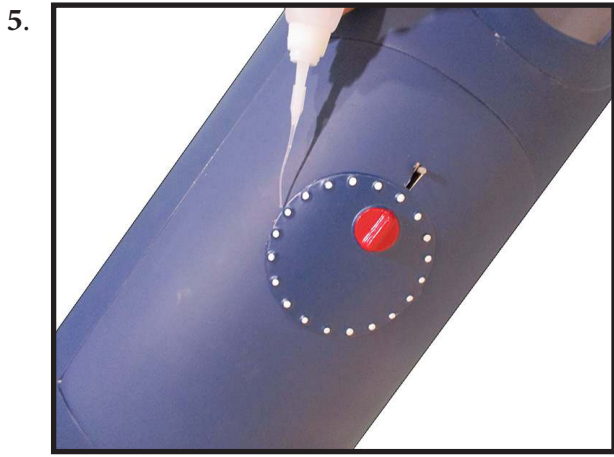

INSTALLING ANTENNAS

Antennas feature banana plugs for easy installation and removal.

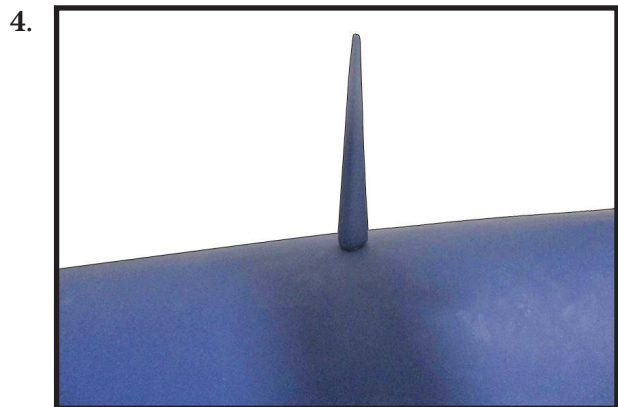
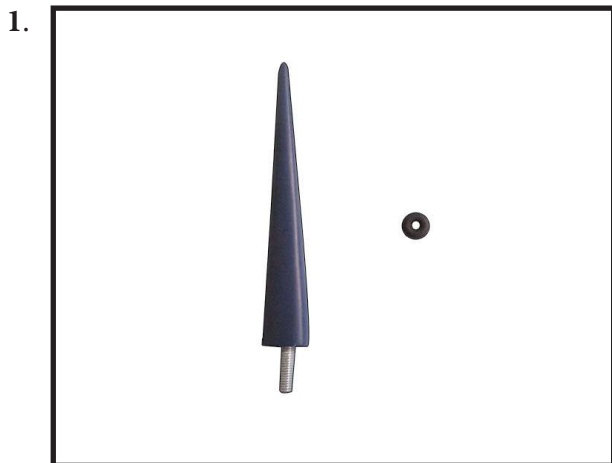

INSTALL MACHINE GUN

Please study images below.



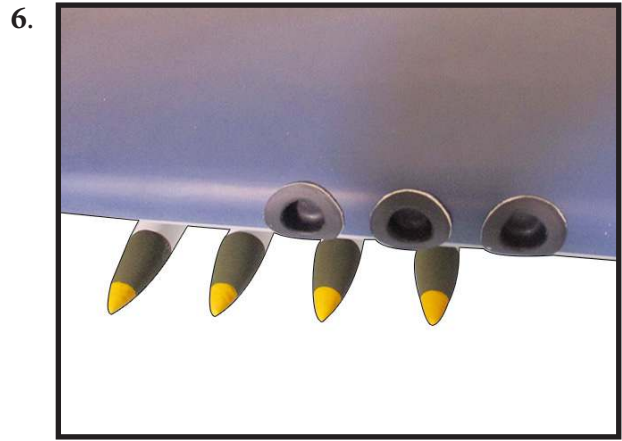
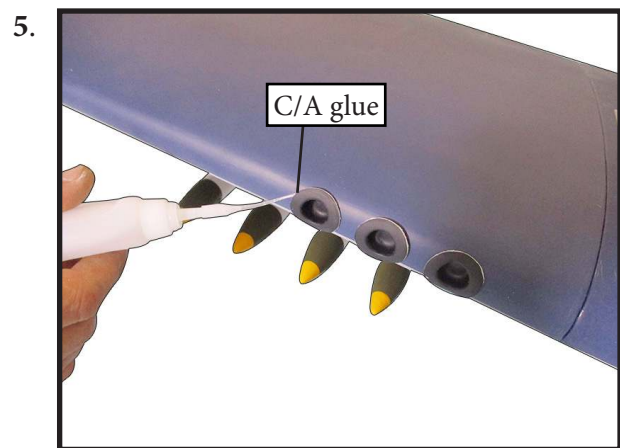
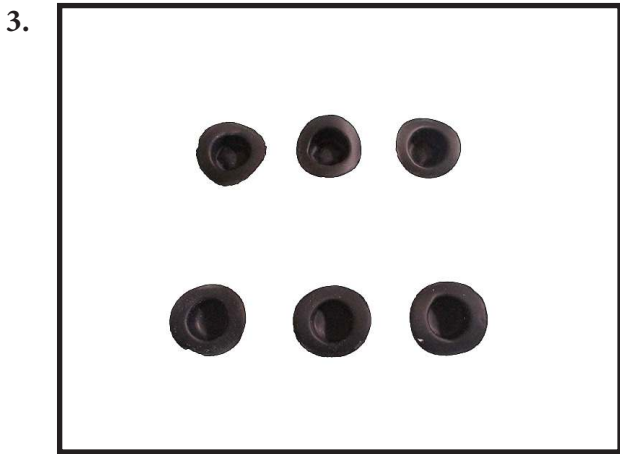

INSTALL PITOT TUBE (PROT WING)

Please study images below.

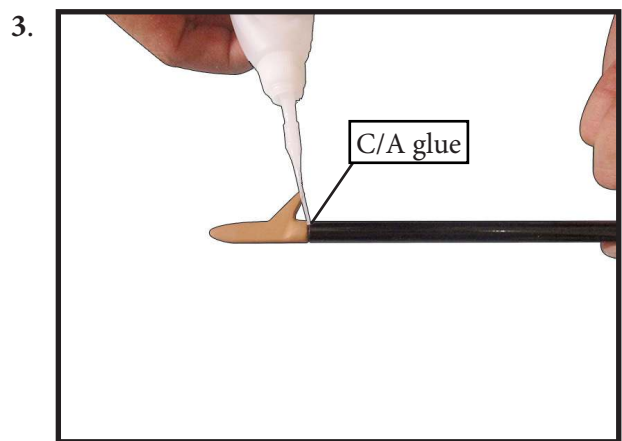
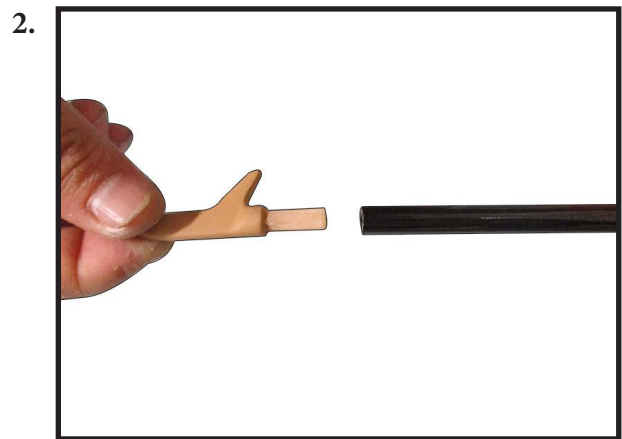

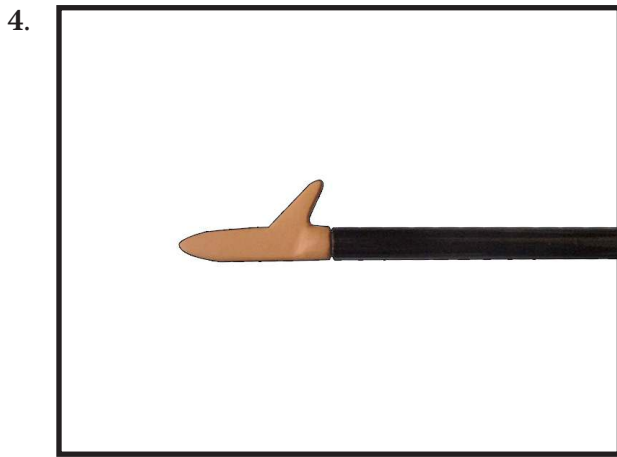

APPLYING DECALS

Please use scissors and/or a hobby knife to cut the decals from the sheet. Please be certain the model is clean and free from oily fingerprints and dust. Position decal on the model where desired. You may use the photos on the box and/or online images to aid in their location and application.

If using custom decals, please follow manufacturers instructions to install those decals. Please be certain the model is clean and free from oily fingerprints and dust. Position decal on the model where desired, using images of appropriate artwork/photos to aid in their location.

BALANCING - DO NOT SKIP THIS!

It is **critical** that your airplane be balanced correctly. Improper balance will cause your plane to lose control and crash. **THE CENTER OF GRAVITY IS LOCATED CG-120MM BACK FROM THE LEADING EDGE OF THE WING AT THE WING ROOT.**

Landing gear should be in the “up” retracted position when balancing.

Mount the wing to the fuselage. Place a piece of masking tape on the top of each wing 145mm back from the leading edge at the wing root.

With the model inverted, place your fingers on the masking tape and carefully lift the plane. This is the point at which your model should balance for your first flights. Later, you may wish to experiment by shifting the balance up to 10mm forward or back to change the flying characteristics. Moving the balance forward may improve the smoothness and arrow-like tracking, but it may then require more speed for take off and make it more difficult to slow down for landing. Moving the balance aft makes the model more agile with a lighter and snappier “feel”. In any case, please start at the location we recommend.

* If possible, first attempt to balance the model by changing the position of the receiver battery and receiver. If you are unable to obtain good balance by doing so, then it will be necessary to add weight to the nose or tail to achieve the proper balance point.

With the wings attached to the fuselage, all parts of the model installed (ready to fly), and empty fuel tanks, hold the model at the marked balance point with the stabilizer level.

Lift the model. If the tail drops when you lift, the model is “tail heavy” and you must add weight* to the nose. If the nose drops, it is “nose heavy” and you must add weight* to the tail to balance.

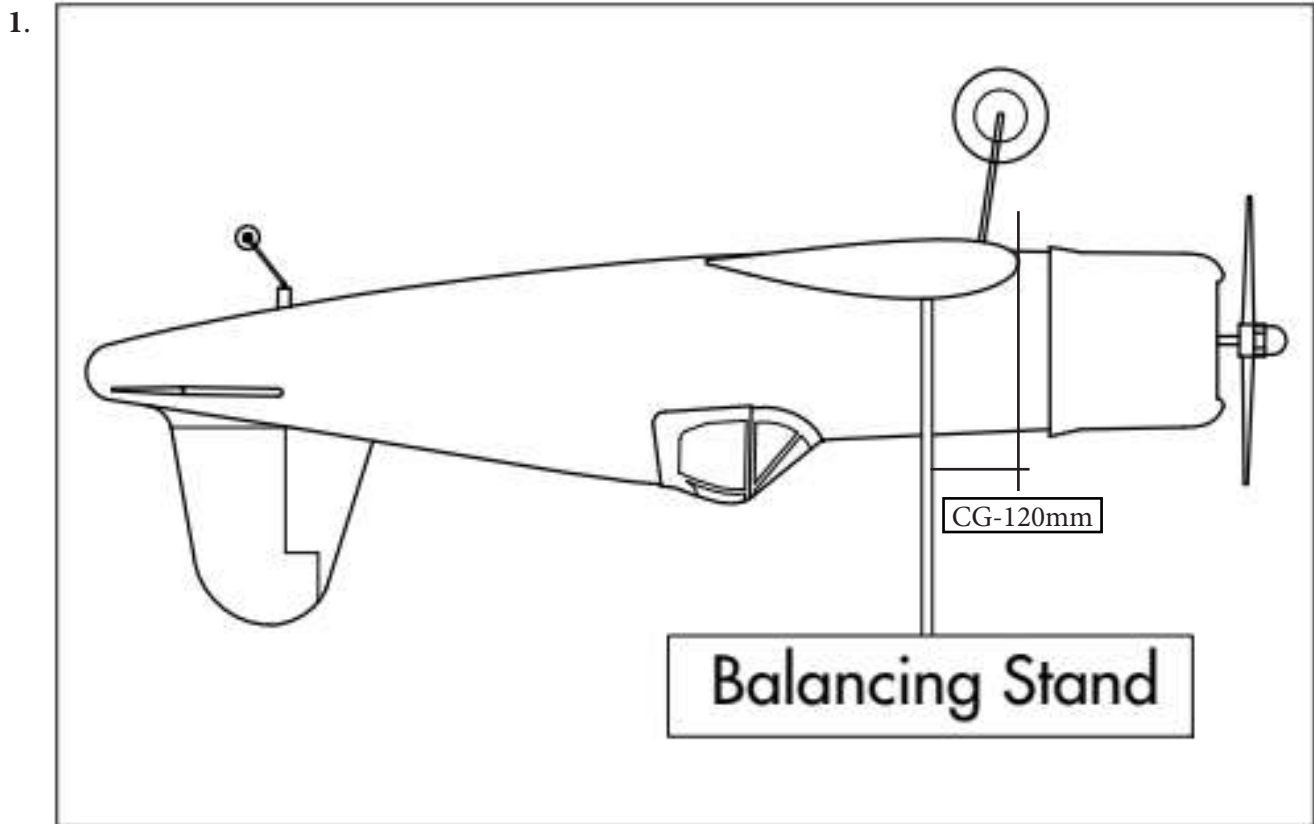

CONTROL THROWS

Ailerons:	Rudder:
High Rate :	High Rate :
Up : 30 mm	Right : 35 mm
Down : 30 mm	Left : 35 mm
Low Rate :	Low Rate :
Up : 25 mm	Right : 30 mm
Down : 25 mm	Left : 30 mm
Elevator:	Flap:
High Rate :	Mid : 50mm
Up : 25 mm	Full : 70mm
Down : 25 mm	
Low Rate :	
Up : 20 mm	
Down : 20 mm	

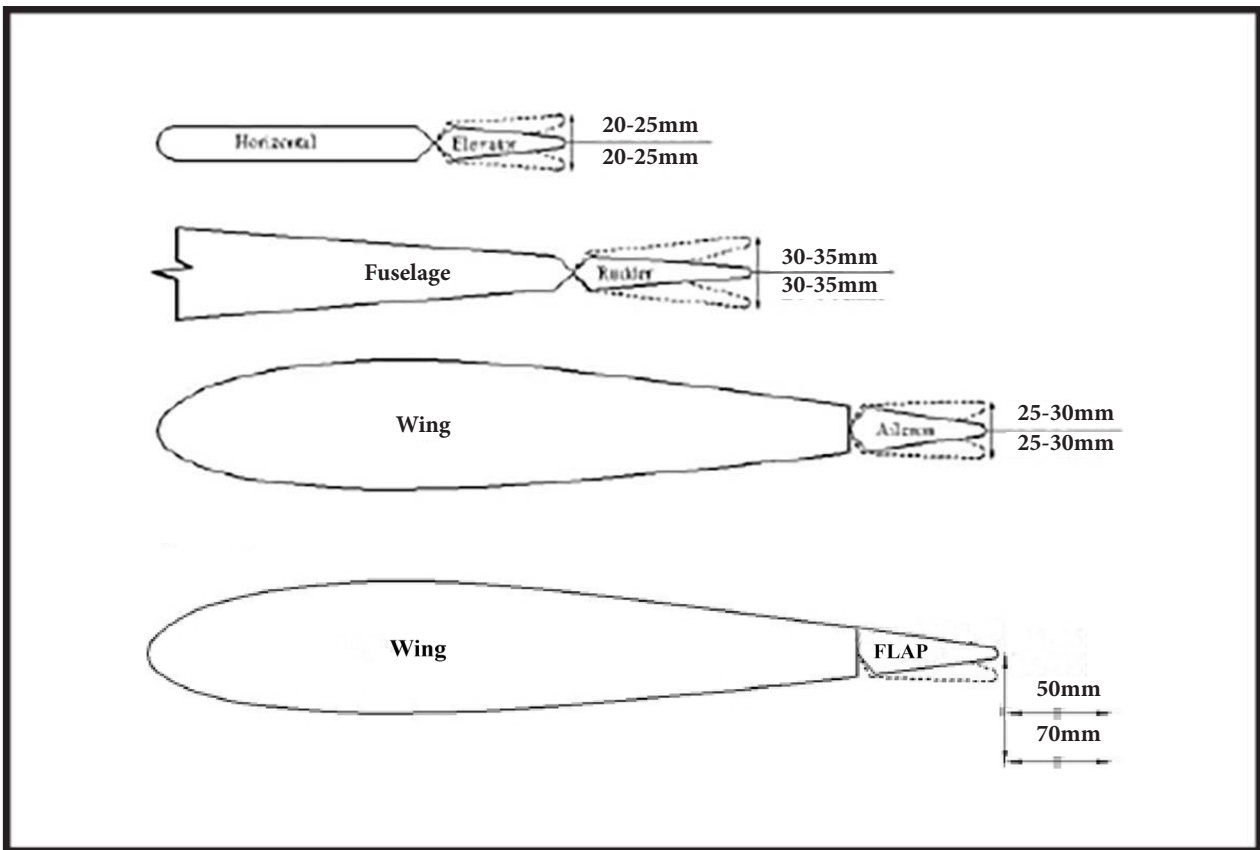

FLIGHT PREPARATION

Check the operation and direction of the elevator, rudder, ailerons and throttle.

- A) Plug in your radio system per the manufacturer's instructions and turn everything on.
- B) Check the elevator first. Pull back on the elevator stick. The elevator halves should move up. If it they do not, flip the servo reversing switch on your transmitter to change the direction.
- C) Check the rudder. Looking from behind the airplane, move the rudder stick to the right. The rudder should move to the right. If it does not, flip the servo reversing switch on your transmitter to change the direction.
- D) Check the throttle. Moving the throttle stick forward should open the carburetor barrel. If it does not, flip the servo reversing switch on your transmitter to change the direction.
- E) From behind the airplane, look at the aileron on the right wing half. Move the aileron stick to the right. The right aileron should move up and the other aileron should move down. If it does not, flip the servo reversing switch on your transmitter to change the direction.

PREFLIGHT CHECK

- 1) Completely charge your transmitter and receiver batteries before your first day of flying.
- 2) Check every bolt and every glue joint in the **Giant Scale F4U Goodyear FG-1D 60cc ARF 87" Limited Edition** to ensure that everything is tight and well bonded.
- 3) Double check the balance of the airplane. Do this with the fuel tank empty.
- 4) Check the control surfaces. All should move in the correct direction and not bind in any way.
- 5) If your radio transmitter is equipped with dual rate switches double check that they are on the low rate setting for your first few flights.
- 6) Check to ensure the control surfaces are moving the proper amount for both low and high rate settings.
- 7) Check the receiver antenna. It should be fully extended and not coiled up inside the fuselage.
- 8) Properly balance the propeller. An out of balance propeller will cause excessive vibration which could lead to engine and/or airframe failure.

We wish you many safe and enjoyable flights
with your Giant Scale F4U Goodyear FG-1D 60cc ARF 87" Limited Edition.

*If you have any queries, or are interested in our products,
please feel free to contact us*

Factory : 12/101A - Hamlet 4 - Le Van Khuong Street - Dong Thanh Ward -
Hoc Mon District - Ho Chi Minh City - Viet Nam.

Office : 62/8 Ngo Tat To Street - Ward 19 - Binh Thanh District - Ho Chi Minh
City - Viet Nam

Phone : 848 - 86622289 or 848- 36018777

Website : www.SeagullModels.com

Email : Sales@seagullmodels.com

Facebook : www.facebook.com/SeaGullModels.