



CRITICAL MASS

OPERATING MANUAL



www.rochobby.com

Please visit our homepage for updated product information

WARNING

 **WARNING:** Read the ENTIRE instruction manual to become familiar with the features of the product before operating. Failure to operate the product correctly can result in damage to the product, personal property and cause serious injury.

This is a sophisticated hobby product and NOT a toy. It must be operated with caution and common sense and requires some basic mechanical ability. Failure to operate this Product in a safe and responsible manner could result in injury or damage to the product or other property. This product is not intended for use by children without direct adult supervision.

This manual contains instructions for safety, operation and maintenance. It is essential to read and follow all the instructions and warnings in manual, prior to assembly, setup or use, in order to operate correctly and avoid damage or serious injury.

Safety Precautions and Warnings

As the user of this product, you are solely responsible for operating in a manner that does not endanger yourself and others or result in damage to the product or the property of others. This model is controlled by a radio signal subject to interference from many sources outside your control. This interference can cause momentary loss of control so it is advisable to always keep a safe distance in all directions around your model, as this margin will help avoid collisions or injury.

Age Recommendation: Not for children under 14 years. This is not a toy.

- Never operate your model with low transmitter batteries.
- Always operate your model in an open area away from cars, traffic or people.
- Avoid operating your model in the street where injury or damage can occur.
- Never operate the model in the street or in populated areas for any reason.
- Carefully follow the directions and warnings for this and any optional support equipment (chargers, rechargeable battery packs, etc.) you use.
- Keep all chemicals, small parts and anything electrical out of the reach of children.
- Moisture causes damage to electronics. Avoid water exposure to all equipment not specifically designed and protected for this purpose.
- Never lick or place any portion of your model in your mouth as it could cause serious injury or even death.



Install the control horns

1. The control surface horns for the elevator are stapled to the bag containing the elevator, do not accidentally discard them.



2. The side of the stabilizer that contains the slot for the carbon rod is the down side, make sure to install the control horns on this side.

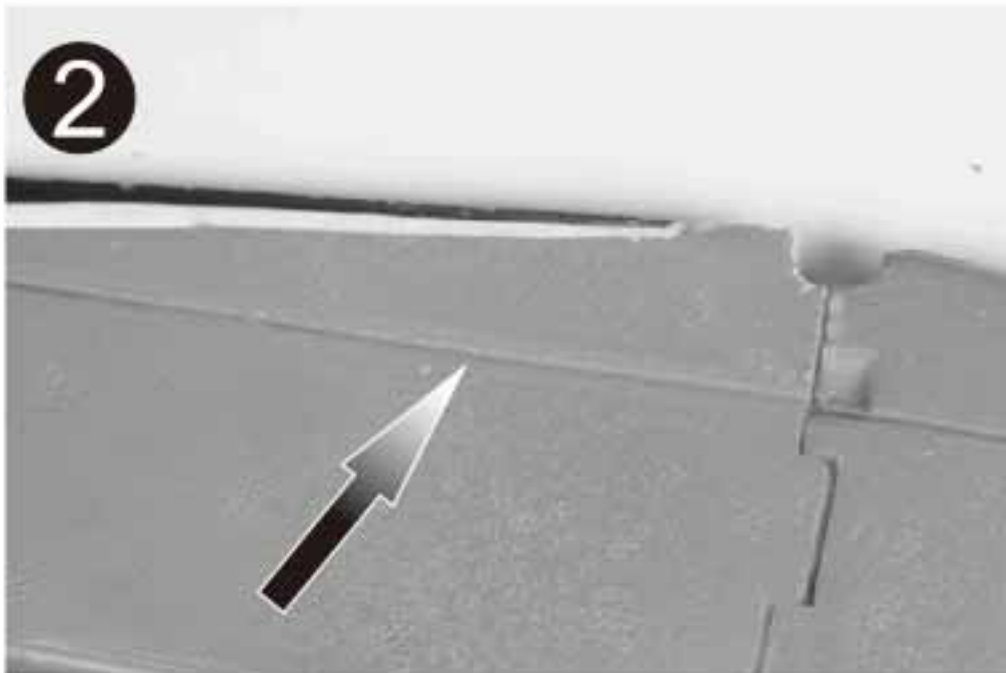

3. Make sure the control surface horns are facing the right direction before installing



4. Install the elevator control surface horns on the bottom of the elevator surface with the screws provided in the small plastic bag.

Note: Thread in the screws from the backplate side.

Always make sure that the screws are grabbing into the back plates of the control horns.

It is very important that these parts are holding tight.



5. Attach the rudder control horn on the starboard (right) side of the rudder.

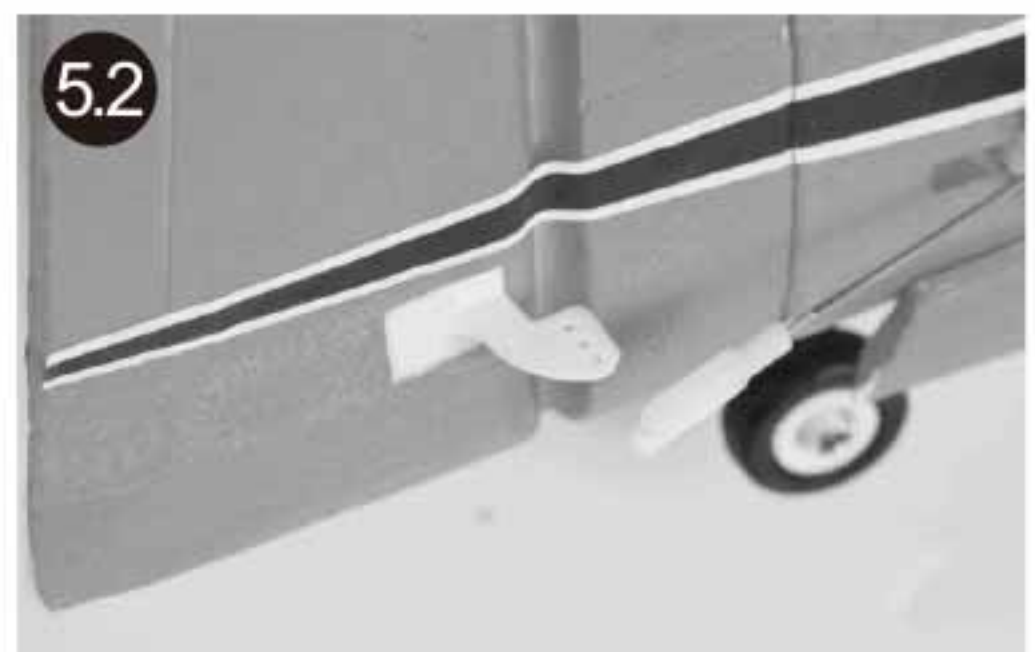
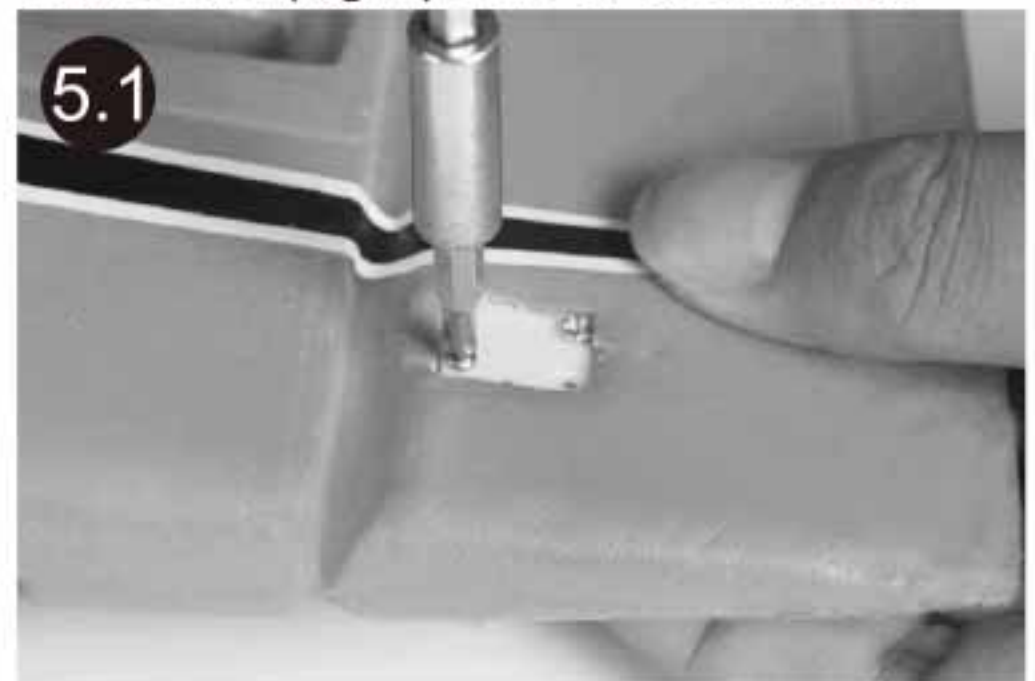

Install the control horns

6. Now attach the aileron surface control horns to the bottom of the lower main-wing .

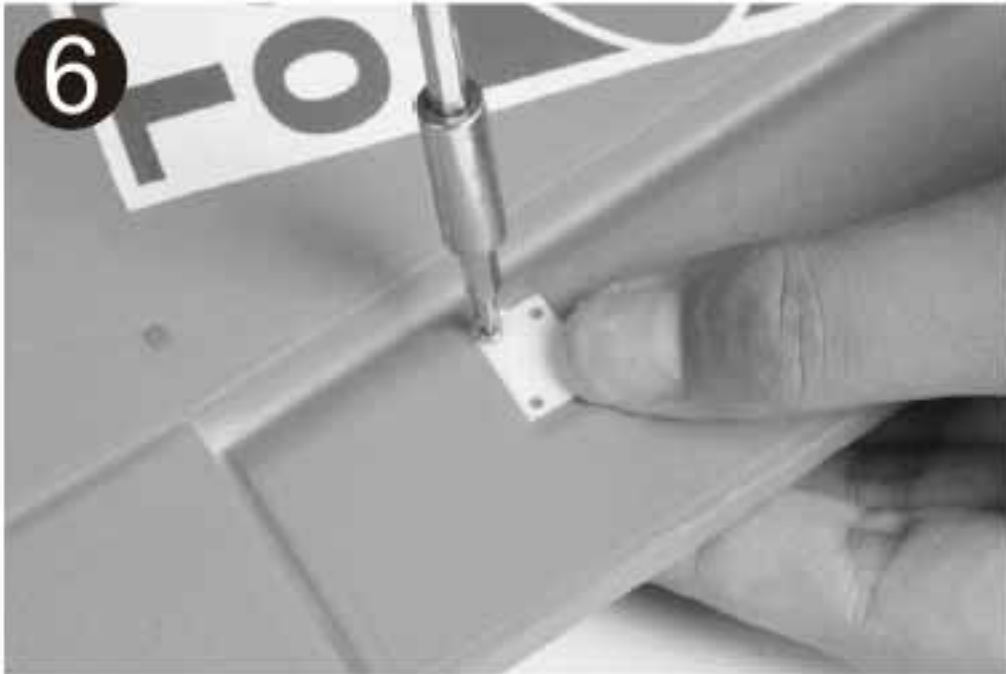

7. Attach the flap control surface horns, you will need to open the flap to install the back plate.



Installation of the linkage rod

1. Put the Z-bend end of the linkage into the desired servo control horn hole. It is a tight fit and should allow the linkage to move just slightly within the hole to avoid binding up.



2. Snap the clevis into the surface control horn.

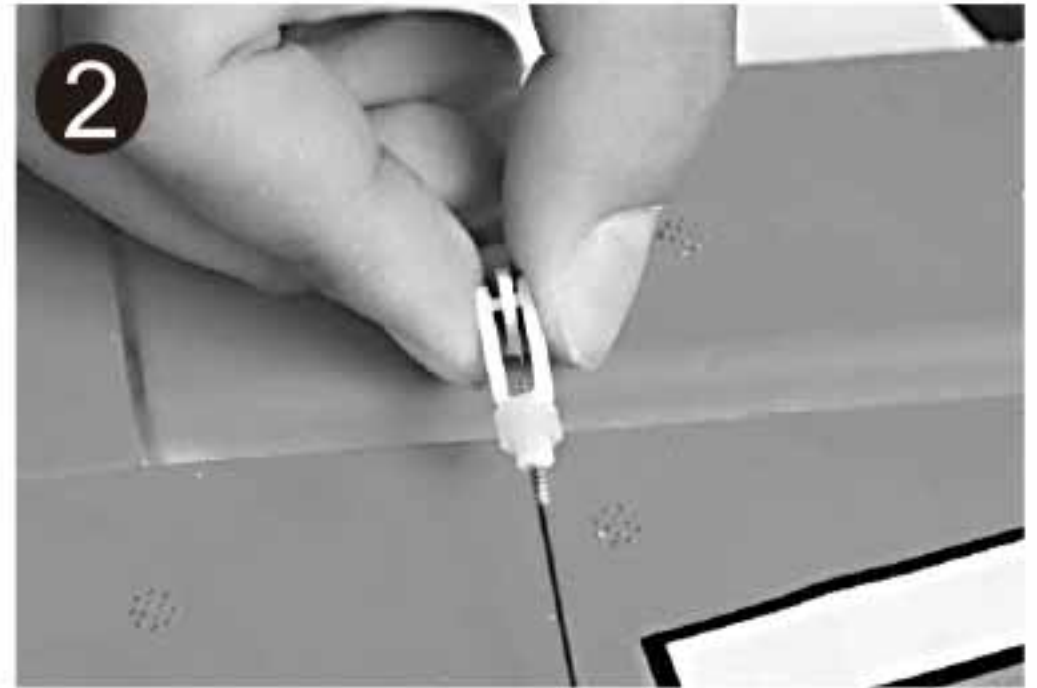

3. The provided piece of fuel tubing keeps the clevis closed during flight. Do all the linkages the same way.



Install the stabilizer

1. Prepare an appropriate amount of glue for the stabilizer installation



2. Apply glue to the portion of the carbon rod that will be inserted into the horizontal stabilizer.

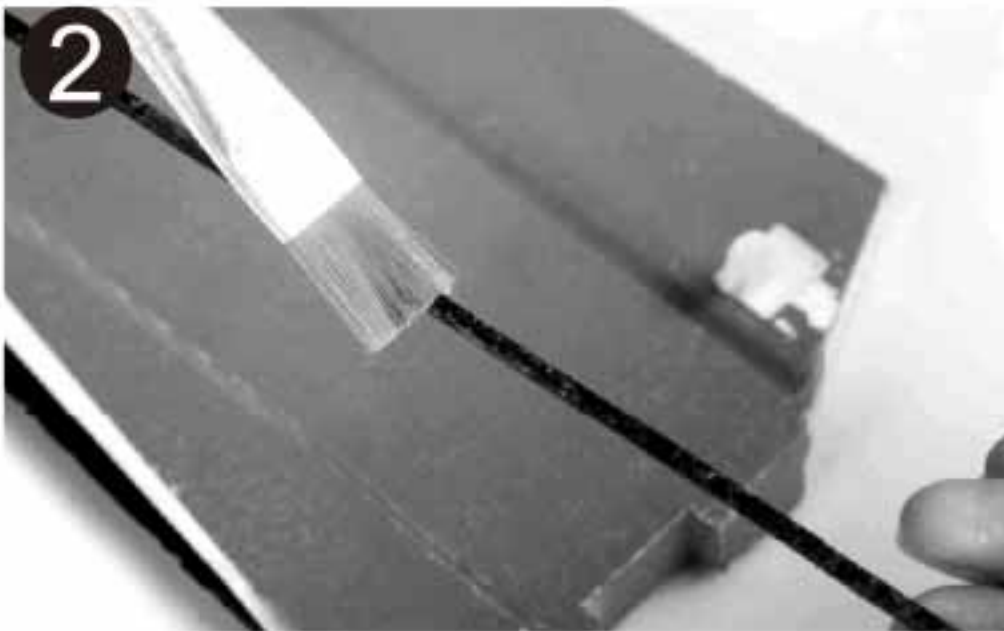

3. Insert the carbon rod into the port side (left) stabilizer.

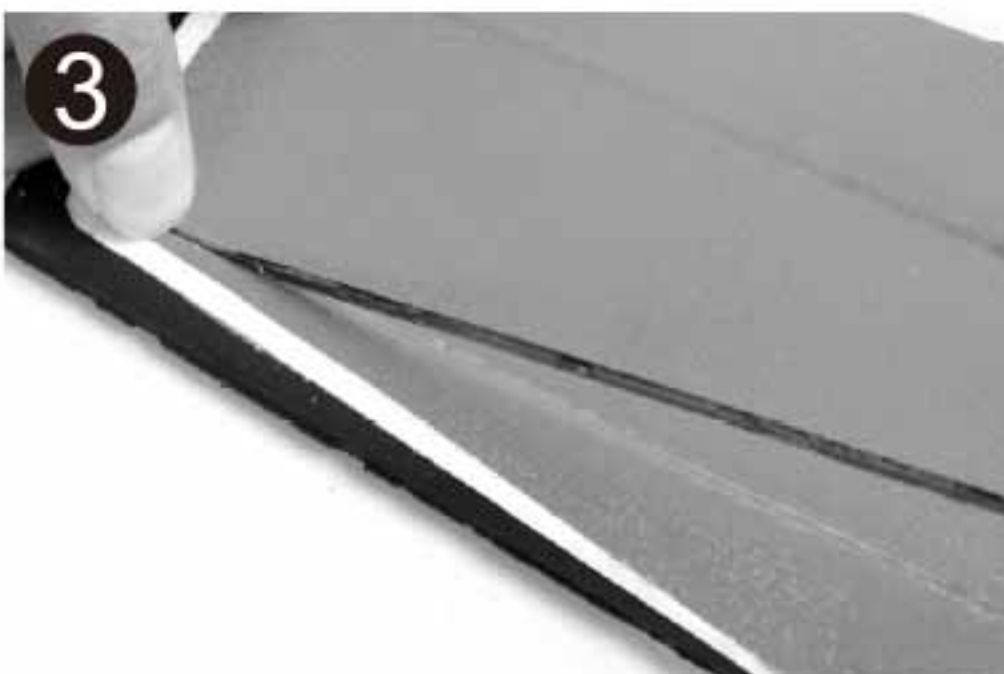

4. Apply glue to the remaining half of the carbon rod and to the mating edge of the stabilizer.



5. Apply glue on the port side of the groove for fitting the stabilizer.



Install the stabilizer

6. Mount the port side stabilizer into the groove with the carbon rod side face down.



7. Apply glue on the other stabilizer half.



8. Turn the fuselage over so the bottom of the stabilizer faces up. Apply glue to the carbon rod. Then slide the carbon rod into the groove and fully seat the stabilizer into the fuselage tail slot.



9. Center the stabilizer as shown in the image below.

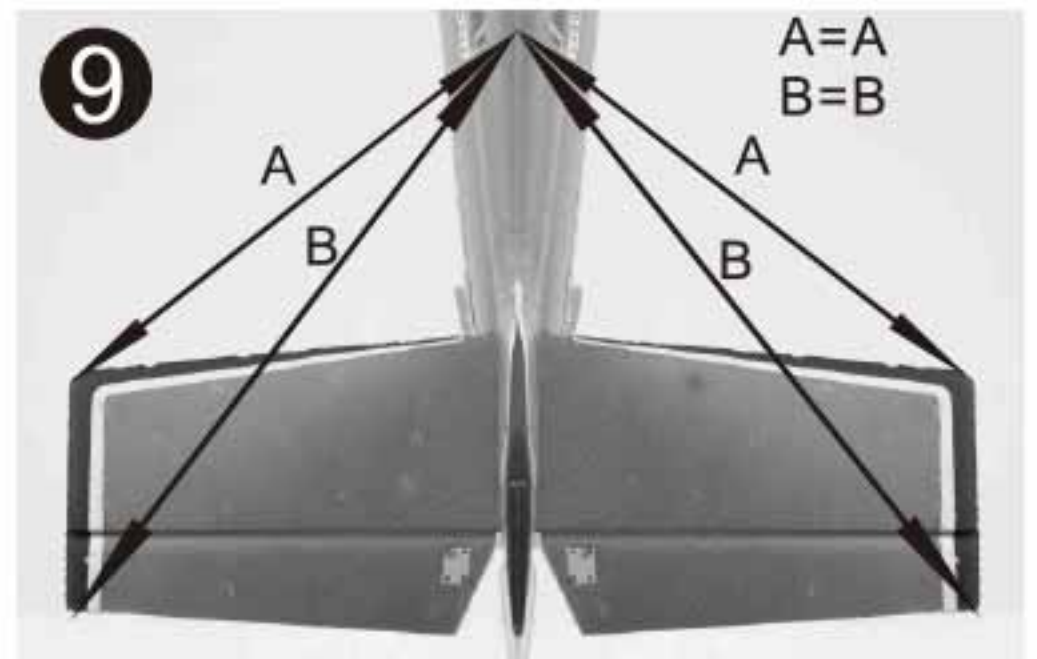

10. Make sure the stabilizer is parallel to the wing as shown. Adjust any misalignment before the glue dries thoroughly.



Mount the main wing to the fuselage

1. Remove the battery hatch by lifting the cover from the rear end. The Hatch cover attaches to the fuselage using four magnets.



2. Position the wing so the main wing fits into the wing bay. Guide the cables through the hole on the bottom of the fuselage. Put the wing in place and at the same time, gently pull the servo cables from inside the canopy to avoid any tangling of cables.

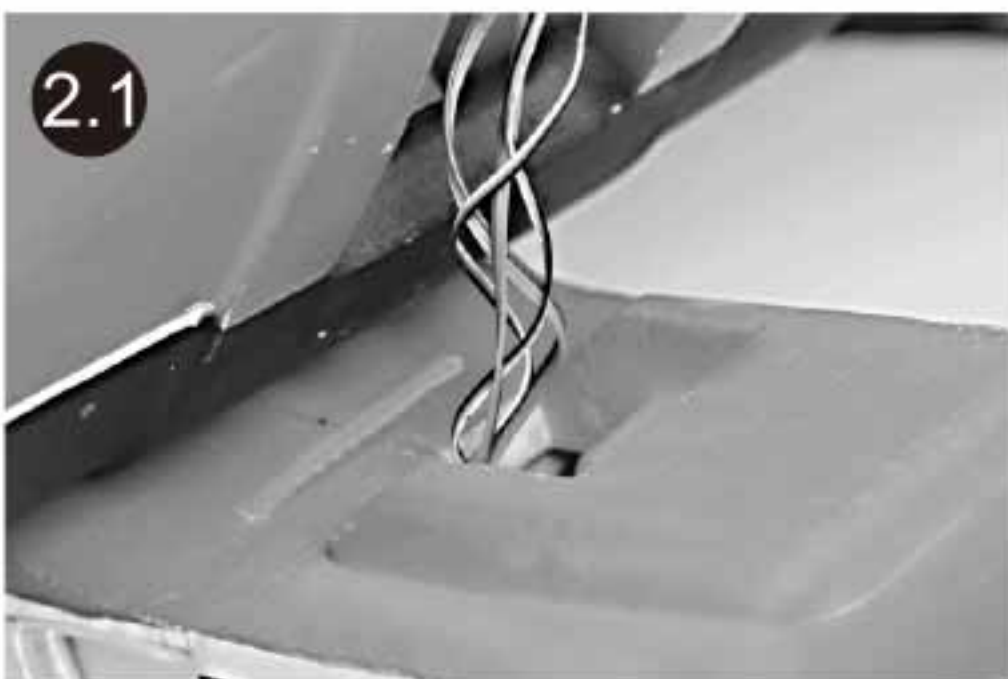

3. Attach the main wing using four pieces of the provided self tapping screws. Two screws are used for the rear wing bolt washers (PM3.0X30 2PCS), two for the front wing washers. (PM3.0X50 2PCS)

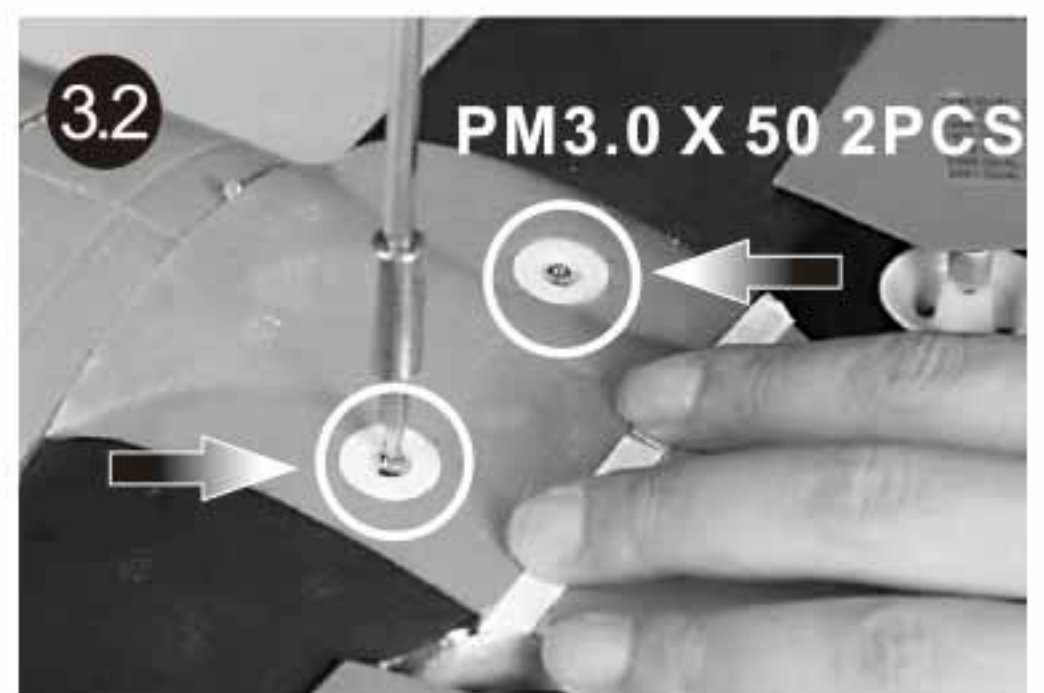
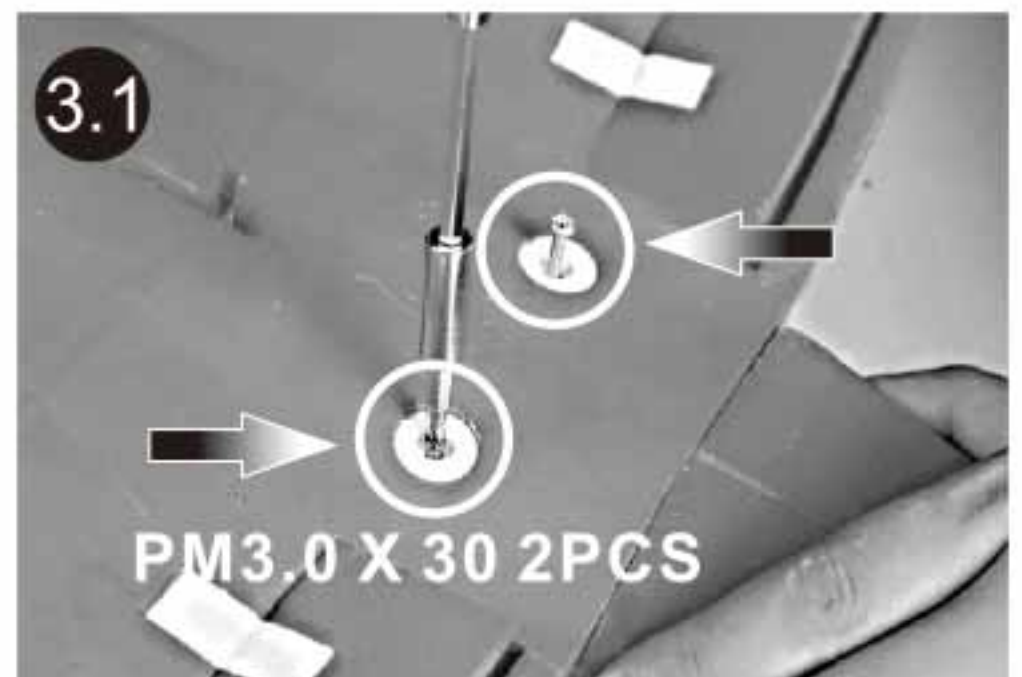

Wire connecting

1. Locate the battery in front of the hatch cover bay.



2. The nose on the hatch cover will hold the battery in position.

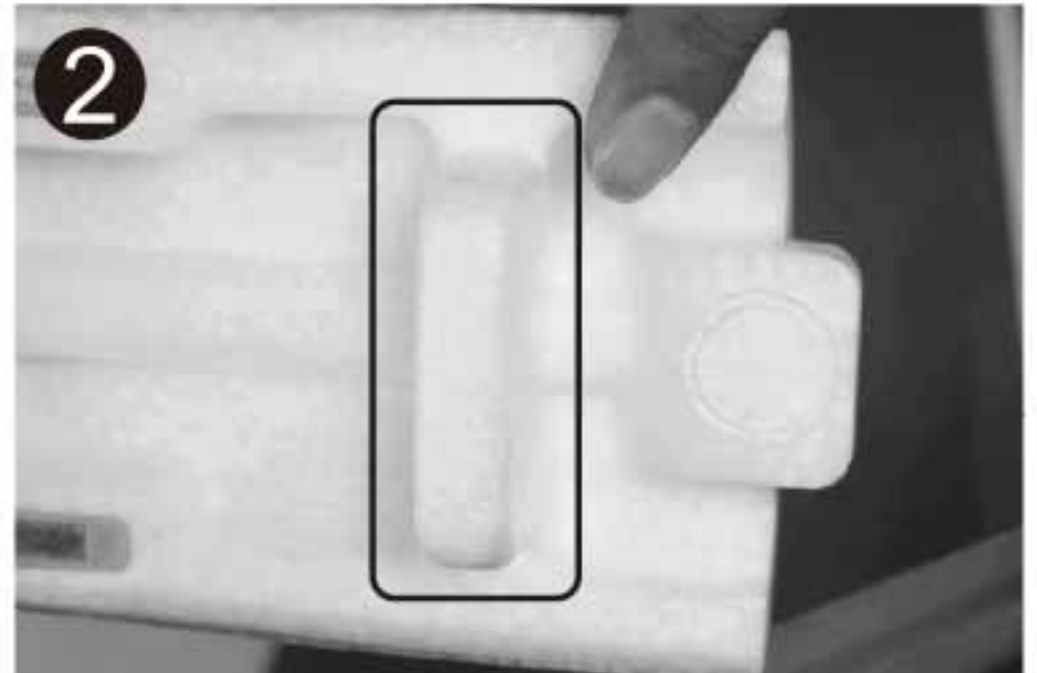

Wire connection diagram

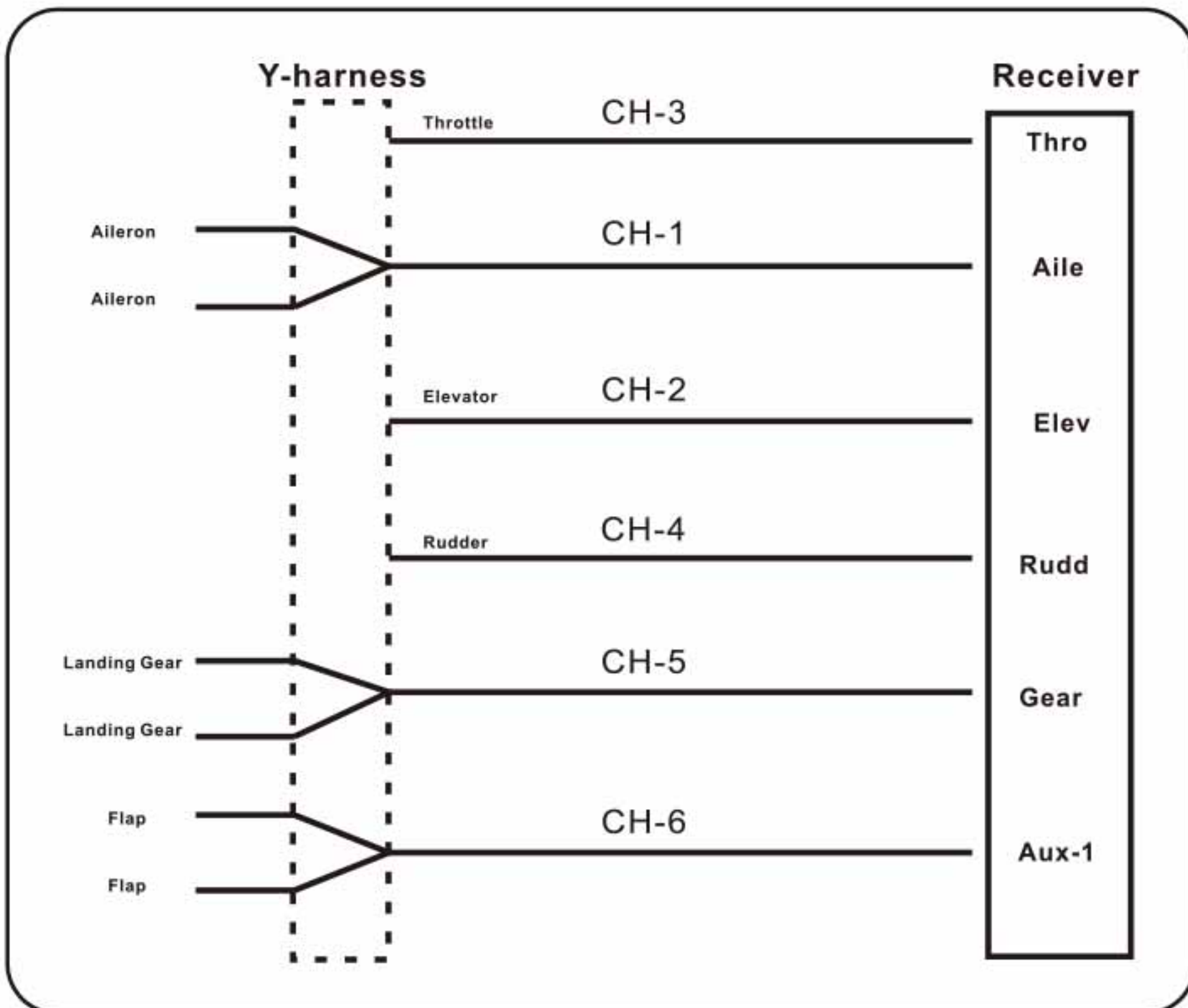

Note: All servo and retract leads have been specifically labeled for your convenience. Use the provided Y-harness for situations where two servos are controlled by one channel; for example ailerons, landing gear, and flaps. Refer to the diagram above for recommended connections.

Control surface testing and setting

1. Before getting started, bind your receiver with your transmitter. Please refer to your **Transmitter Manual** for proper operation. **CAUTION:** To prevent personal injury, **DO NOT** install the propeller assembly onto the motor shaft while testing the control surfaces.

Make sure all control sticks on your radio are in the neutral position (rudder, elevator, ailerons) and the throttle is in the **OFF** position.

All servos have been factory set to the neutral position. Thread the clevis on the linkage rods for each aileron and adjust the clevis so that the control surface aligns with the trailing edge of the wing tip. **Note:** Please secure the clevis to the control horn when the adjustment is complete.



2. Adjust the split elevators so that they are flush with the stabilizer. **Note:** We recommend you use the clevises to adjust the trim rather than using the electronic trim function on your transmitter. This will allow you full asymmetrical trim ability while you are airborne.

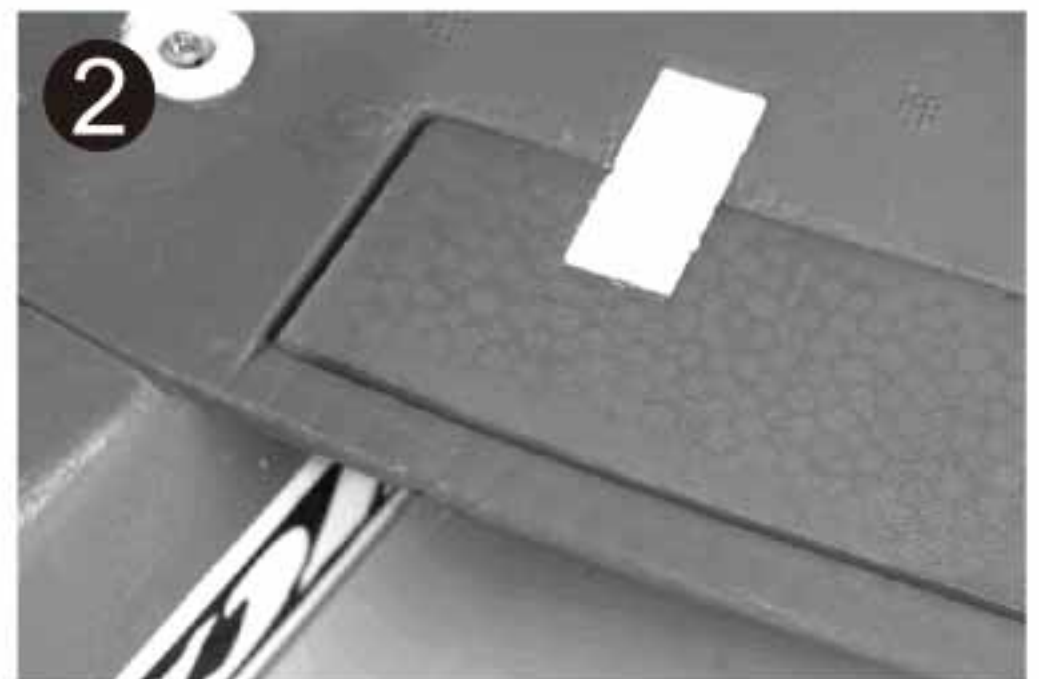

3. Set the rear landing gear neutral position by loosening the screw on control connector and moving the linkage rod. Be sure to tighten the screw when the adjustment is complete.

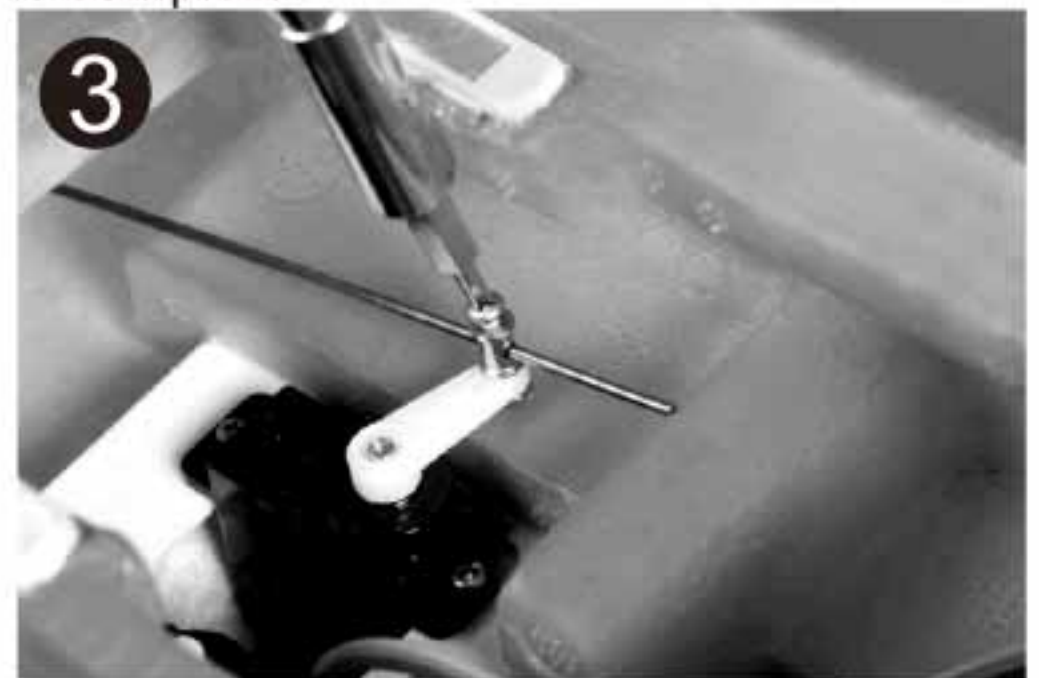

4. Make sure the rear landing gear tire aligns with the fuselage centerline.



Control surface testing and setting

5. Adjust the rudder using the same method as the ailerons. Make sure the rudder aligns with the fuselage centerline.

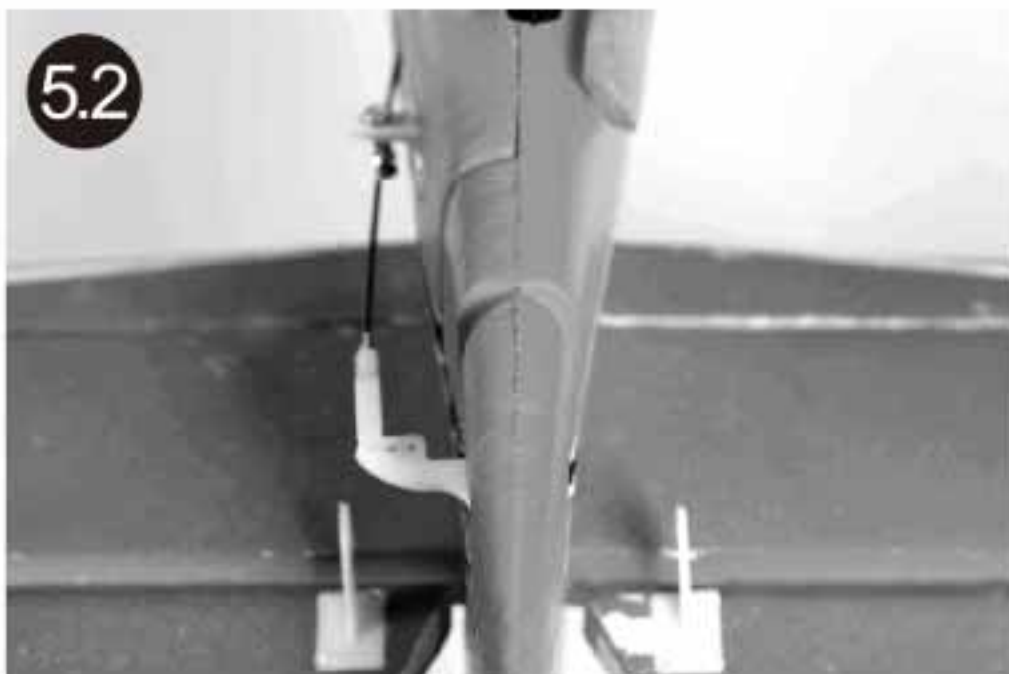

6. Adjust the two split elevator halves using the same method as the ailerons. Make sure the elevator halves are level with each other.

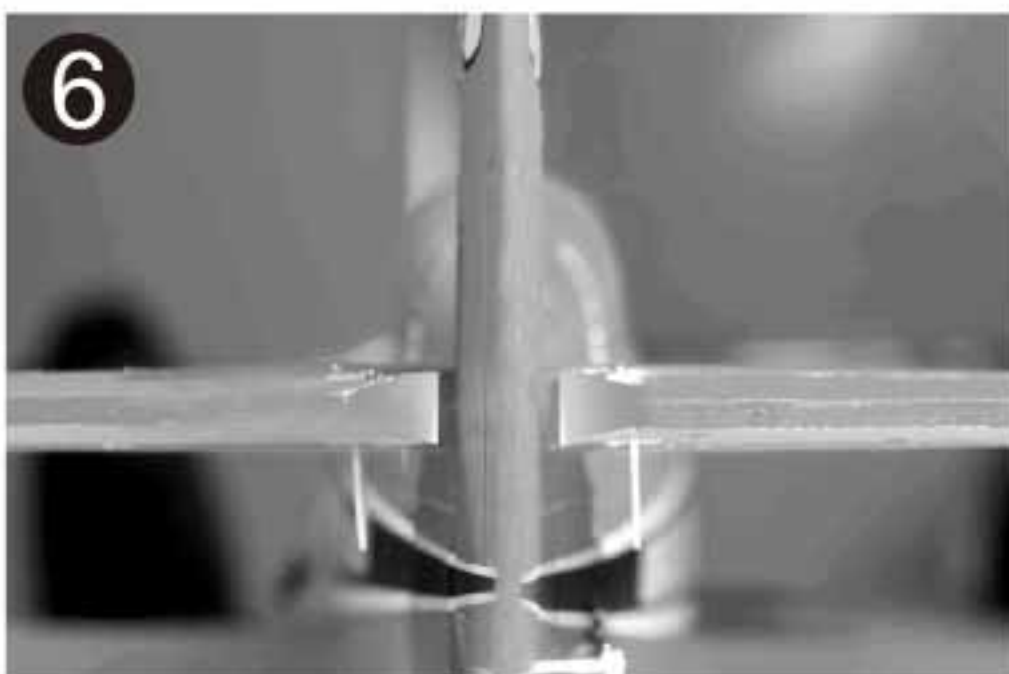

7. Adjust the split elevators so that they are flush with the stabilizer.

Note: We recommend you use the clevises to adjust the trim rather than using the electronic trim function on your transmitter. This will allow you full asymmetrical trim ability while you are airborne.



8. Cycle the retractable main landing gears several times to ensure proper function.



Install the propeller

1. Disconnect the battery from airplane's Electronic Speed Control (ESC). Put the spinner backplate onto the motor shaft, making sure the hex nut fits properly into the notch in the backplate.



2. Install the propeller onto the motor shaft and fully seat on the director plate.



3. Make sure the painted side of the propeller faces the front.



4. Install the spinner middle part ensuring it seats tight to the backplate.



5. Hand tighten the front part of the spinner to secure the complete assembly.



CAUTION: Before testing the propeller, make sure the tail of the plane is firmly on the ground and ensure there are no people or objects in the range of the propeller.

Main specification

The low normal speed version

Wingspan : 1100mm /43.3 in
Length : 918mm /36.1in
Weight : 1090g /38.4oz
CG Position : 50mm
Battery : 11.1V 2200mAh Li-Po Battery
ESC : 35A
Motor : 3536-KV750
Wing Area : 24.5dm²
Wing Load : 44.5g/dm²
RC System : 6 Channel, 6 Servos
And 1 Brushless ESC

The speed reed racing version

Wingspan : 1100mm /43.3 in
Length : 918mm /36.1in
Weight : 1090g /38.4oz
CG Position : 50mm
Battery : 14.8V 2200mAh Li-Po Battery
ESC : 70A
Motor : 3648-KV770
Wing Area : 24.5dm²
Wing Load : 44.5g/dm²
RC System : 6 Channel, 6 Servos
And 1 Brushless ESC

Center of Gravity

When balancing your model, adjust the motor battery as necessary so the model is level or slightly nose down.

This the correct balance point for your model.

After the first flights, The **CG** position can be adjusted for your personal preference.

1. The recommended Center of Gravity(**CG**) location for your model is (50~55mm/2.2in) back from the leading edge of the top main wing as shown with the battery pack installed. Mark the location of the **CG** on top of the wing.
2. When balancing your model, support the plane inverted at the marks made on the top of the main wing with your fingers or a commercially available balancing stand. This is the correct balance point for your model, Make sure the model is assembled and ready for flight before balancing.

Note: Always balance the plane with the retracts down.

Control throw setting

1. Turn on the transmitter and receiver of your model.
check the movement of the rudder using the transmitter.
When the stick is moved right, the rudder should also move right. Reverse the direction of the servo at the transmitter if necessary.
2. Check the movement of the elevator with the radio system.
Moving the elevator stick toward the bottom of the transmitter makes the airplane elevator move up.
3. Check the movement of the ailerons with the radio system, moving the aileron stick right makes the right aileron move up and left aileron move down.
4. Use a ruler to adjust the throw of the elevator, aileron and rudder.
Adjust the position of the pushrod at the control horn and the transmitter to achieve the following measurements when moving the sticks to the end point.

Note: Always disassemble the propeller set when binding the transmitter and testing the control surface.

Main specification and spare parts

The suggested throws for the ROCHOBBY CRITICAL MASS are as follows:

High rate

Elevator - 15mm/0.6in up and down
 Rudder - 15mm/0.6in left and right
 Ailerons - 28mm/0.7in up and down
 Flaps - Mid 22mm/1.2in
 Full 30.5mm/1.2in

Low rate

9mm/0.04in up and down
 9mm/0.04in left and right
 17mm/0.7in up and down

Spare parts list for silver scheme

Item# Description

KT-101 Fuselage
 KT-102 Main wing
 KT-103 Elevator (One set)
 KT-104 Cowl
 KT-105 Servo hatch cover
 KT-106 Canopy (One pc plastic canopy)
 KT-107 Propeller
 KT-108 Spinner
 KT-109 Main landing gear (One set)
 KT-110 Linkage rod (One set linkage rod)
 KT-111 Main landing gear assembly (One set)
 KT-112 9 g servo (standard speed)
 KT-112-1 9 g Metal gear servo (high speed)
 KT-113 Retract (One pc for main landing gear)
 KT-114 Motor (3536-KV750)
 KT-114-1 Motor (3648-KV770)
 KT-115 ESC (35A)
 KT-115-1 ESC (70A)
 KT-116 Battery (11.1V, 2200mAh, 25c)
 KT-116-1 Battery (14.8V, 2200mAh, 25c)
 KT-117 Motor Board V1
 KT-117-1 Motor Board V2
 KT-118 Motor Base
 KT-119 Motor Shaft
 KT-119-1 Motor Shaft
 KT-120 Sticker (One set sticker)
 KT-121 9 g servo for flaps

Center Of Gravity(C.G.)



Spare Parts List



KT-101



KT-102



KT-103



KT-104



KT-105



KT-106



KT-107



KT-108



KT-109

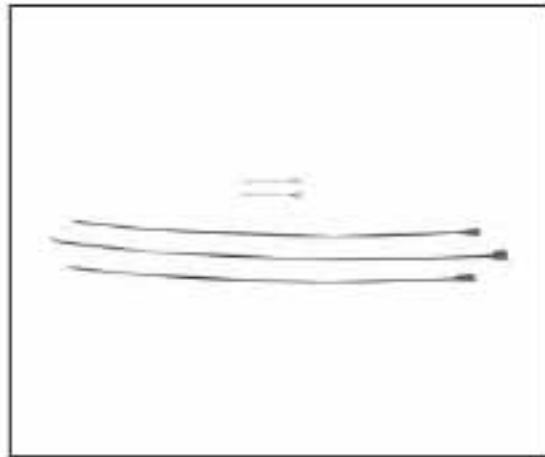

KT-110



KT-111



KT-112



KT-113



KT-114

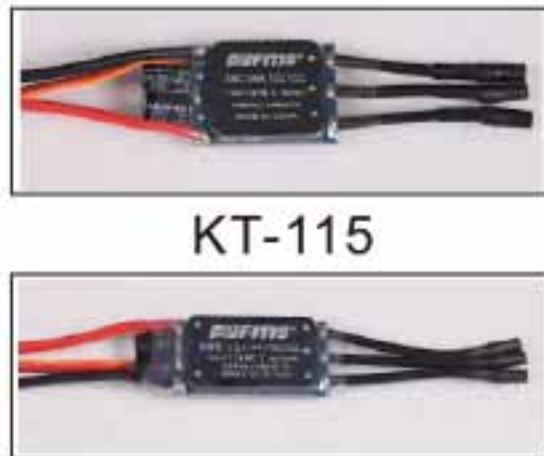

KT-115

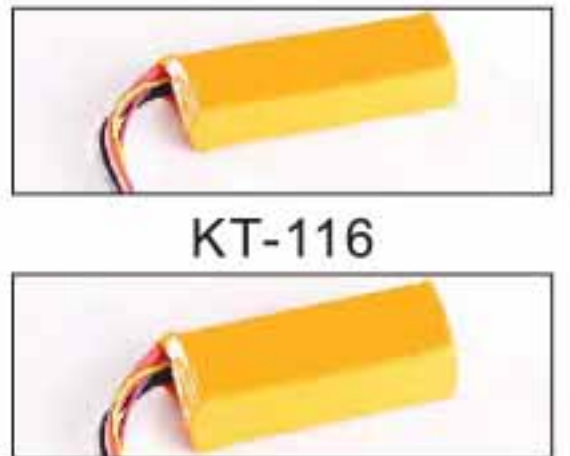

KT-116



KT-117



KT-118



KT-119



KT-120



KT-117-1



KT-119-1

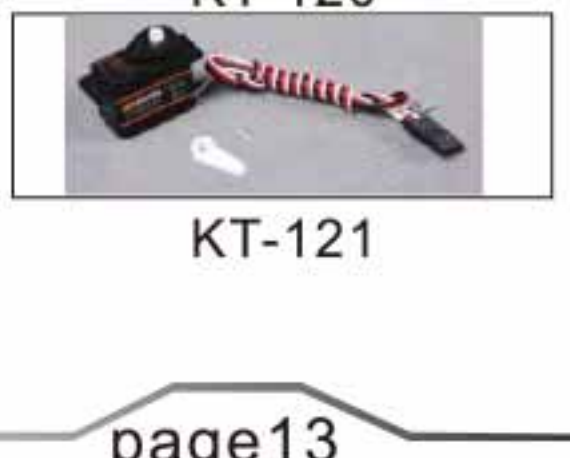

KT-121

Troubleshooting

Problem	Possible Cause	Solution
Aircraft will not respond to the throttle but responds to other controls.	ESC is not armed. Throttle channel is reversed.	Lower throttle stick and throttle trim to lowest settings. Reverse throttle channel on transmitter.
Extra propeller noise or extra Vibration.	Damaged spinner, propeller, motor or motor mount. Loose propeller and spinner parts. Propellor installed backwards.	Replaced damaged parts. Tighten parts for propeller adapter, propeller and spinner.
Reduced flight time or aircraft underpowered.	Flight battery charge is low. Propeller installed backward. Flight battery damaged.	Remove and install propeller correctly. Completely recharge Flight battery. Replace flight battery and obey flight battery instructions.
Control surface does not move, or is slow to respond to control inputs.	Control surface, control horn, linkage or servo damage, Wire damaged or connections loose.	Replace or repair damaged parts and adjust controls. Do a check of connections for loose wiring.
Control reversed.	Channels need be reversed in the transmitter.	Do the Control Direction Test and adjust controls for aircraft and transmitter.
Motor loses power. Motor power pulses then motor loses power.	Damage to motor, or battery. Loss of power to aircraft. ESC uses default soft Low Voltage Cutoff(LVC).	Do a check of batteries, transmitter, receiver, ESC, motor and wiring for damage (replace as needed). Land aircraft immediately and Recharge flight battery.
LED on receiver flashes slowly.	Power lose to receiver.	Check connection from ESC to receiver. Check servos for damage. Check linkages for binding.

Battery Selection and Installation.

1. We recommend the 14.8V 2200mAh 25C Li-Po battery.
2. If using another battery, the battery must be at least a 14.8V 2200mAh 25C battery.
3. Your battery should be approximately the same capacity ,dimension and weight as the 14.8V 2200mAh 25C Li-Po battery to fit in the fuselage without changing the center of gravity a large amount.

Flying Tips

Range Check Your Radio System

After final assembly, range check the radio system with the **ROCHOBBY CRITICAL MASS**. Refer to your specific transmitter instruction manual for range test information.

Take off and landing tips

1. Take off using full power, as soon as you have taken off retract the landing gear.
2. Use the flaps to give a steeper landing approach, increase throttle slightly to offset the increased drag.
3. Ensure that you set a timer and land with plenty of battery power in reserve.
4. It is difficult to land the plane perfectly from a high speed flight when the flaps are in the up position.
5. Never exceed 3 minutes of continuous full power flight.
6. Never exceed the limited flying weight.

First Flight Preparation

1. Remove and inspect contents.
2. Charge flight battery.
3. Read this instruction manual thoroughly.
4. Fully assemble model.
5. Install the flight battery in the aircraft (once it has been fully charged).
6. Bind aircraft to your transmitter.
7. Make sure linkages move freely.
8. Make sure the rubber ring has been properly installed on the clevis.
9. Perform the Control Direction Test with the transmitter.
10. Adjust flight controls and transmitter.
11. Perform a radio system Range Check.
12. Find a safe and open area.

Please read the following instructions and fully understand it.

1. Do not fly in strong wind or bad weather.
2. Never fly the model in crowded areas, where there are lots of people, automobiles on the road or power lines overhead. Also do not fly around the airport. Please make yourself enough room for the flying and operating, as the plane can travel at high speed. Remember you are responsible for the safety of others.
3. Children under the age of 12 should have an adult guide. Never recommend for the children under the age of 14.
4. Never leave the charger in wet conditions.
5. The **CRITICAL MASS** is made from PA and polythene which are tinder. When it meets the heat, transfiguration can easily happen, so you must keep it away from heat.
6. Do not attempt to catch the **CRITICAL MASS** while flying, please do not touch the propeller.
7. Never leave this system unattended around children with battery in the unit, as injury may be caused due to children's turning on the transmitter or the plane.
8. During the preparation for the flight, please remember to turn on the transmitter before connecting the battery pack.
9. Close the throttle on the transmitter before connecting battery otherwise the motor may operate.

AMA

If you are not already a member of the AMA, please join, The AMA is the governing body of model aviation and membership provided liability insurance coverage, protects modelers' rights and interests and is required to fly at most R/C sites.

Academy of Model Aeronautics

5151 East Memorial Drive
Muncie, IN 47302-9252
Ph.(800)435-9262
Fax(765)741-0057

Or via the Internet at: <http://www.modelaircraft.org>



Academy of Model Aeronautics National Model Aircraft Safety Code Effective January 1, 2011

- A. GENERAL:** A model aircraft is a non-human-carrying aircraft capable of sustained flight in the atmosphere. It may not exceed limitations of this code and is intended exclusively for sport, recreation and/or competition.
All model flights must be conducted in accordance with this safety code and any additional rules specific to the flying site.
1. Model aircraft will not be flown:
 - (a) In a careless or reckless manner.
 - (b) At a location where model aircraft activities are prohibited.
 2. Model aircraft pilots will:
 - (a) Yield the right of way to all man carrying aircraft.
 - (b) See and avoid all aircraft and a spotter must be used when appropriate.
(AMA Document #540-D-See and Avoid Guidance.)
 - (c) Not fly higher than approximately 400 feet above ground level within three (3) miles of an airport, without notifying the airport operator.
 - (d) Not interfere with operations and traffic patterns at any airport, heliport or seaplane base except where there is a mixed use agreement.
 - (e) Ensure the aircraft is identified with the name and address or AMA number of the owner on the inside or affixed to the outside of the model aircraft.
(This does not apply to model aircraft flown indoors).
 - (f) Not operate aircraft with metal-blade propellers or with gaseous boosts except for helicopters operated under the provisions of AMA Document #555.
 - (g) Not operate model aircraft while under the influence of alcohol or while using any drug which could adversely affect the pilot's ability to safely control the model.
 - (h) Not operate model aircraft carrying pyrotechnic devices which explode or burn, or any device which propels a projectile or drops any object that creates a hazard to persons or property.

AMA

Exceptions:

- ◆ Free Flight fuses or devices that burn producing smoke and are securely attached to the model aircraft during flight.
 - ◆ Officially designated AMA Air Show Teams (AST) are authorized to use devices and practices as defined within the Team AMA Program Document (AMA Document #718).
3. Model aircraft will not be flown in AMA sanctioned events, air shows or model demonstrations unless:
 - (a) The aircraft, control system and pilot skills have successfully demonstrated all maneuvers intended or anticipated prior to the specific event.
 - (b) An inexperienced pilot is assisted by an experienced pilot.
 4. When and where required by rule, helmets must be properly worn and fastened. They must be OSHA, DOT, ANSI, SNELL or NOCSAE approved or comply with comparable standards.

B. RADIO CONTROL (RC)

1. All pilots shall avoid flying directly over unprotected people, vessels, vehicles or structures and shall avoid endangerment of life and property of others.
2. A successful radio equipment ground-range check in accordance with manufacturer's recommendations will be completed before the first flight of a new or repaired model aircraft.
3. RC model aircraft must use the radio-control frequencies currently allowed by the Federal Communications Commission (FCC). Only individuals properly licensed by the FCC are authorized to operate equipment on Amateur Band frequencies.
4. RC model aircraft will not operate within three (3) miles of any pre-existing flying site without a frequency-management agreement (AMA Documents #922-Testing for RF Interference; #923- Frequency Management Agreement)
5. With the exception of events flown under official AMA Competition Regulations, excluding takeoff and landing, no powered model may be flown outdoors closer than 25 feet to any individual, except for the pilot and the pilot's helper(s) located at the flight line.
6. Under no circumstances may a pilot or other person touch a model aircraft in flight while it is still under power, except to divert it from striking an individual. This does not apply to model aircraft flown indoors.
7. RC night flying requires a lighting system providing the pilot with a clear view of the model's attitude and orientation at all times.
8. The pilot of a RC model aircraft shall:
 - (a) Maintain control during the entire flight, maintaining visual contact without enhancement other than by corrective lenses prescribed for the pilot.
 - (b) Fly using the assistance of a camera or First-Person View (FPV) only in accordance with the procedures outlined in AMA Document #550.

C. FREE FLIGHT

1. Must be at least 100 feet downwind of spectators and automobile parking when the model aircraft is launched.
2. Launch area must be clear of all individuals except mechanics, officials, and other fliers.
3. An effective device will be used to extinguish any fuse on the model aircraft after the fuse has completed its function.



Email: info@rochobby.com
[Http://www.rochobby.com](http://www.rochobby.com)

MADE IN CHINA