

QUICRUN USER MANUAL

Sensorless Brushless Motor
QUICRUN 4274/4268 G2

20230705

HW-SMB329DUL00-A0



Thank you for purchasing this HOBBYWING product! The power of brushless power system is powerful. Any improper use may cause personal injury and damage to the product and related devices. We strongly recommend reading through this user manual before use and strictly abide by the specified operating procedures. We shall not be liable for any liability arising from the use of this product, including but not limited to reimbursement for incidental or indirect losses. Meanwhile, we do not assume any responsibility caused by unauthorized modification of the product. We have the right to change the product design, appearance, performance and use requirements without notice.

01 Warnings

- Please carefully check power devices and manual of car chassis to ensure the power pairing is reasonable. Avoid wrong pairing to overload and damage the motor.
- Always wire up all the parts of the system carefully. If any of the connections come loose as a result of vibration, your model RC may lose control.
- Never apply full throttle if the pinion is not installed. Due to the extremely high RPMs without load, the motor may get damaged.
- Never allow the motor case to get 100 degrees Celsius (212 degrees Fahrenheit) because the magnets maybe demagnetized by high temperature.

02 Specifications

Model	KV	LiPos	No-load Current (A)	Diameter/Length (mm)	Shaft Diameter/Length (mm)	Bearing size (mm)	Poles	Weight (g)	Applications
QUICRUN 4274SL 2000KV G2	2000KV	3-6S	5.9A	φ=42mm (1.65") L=74.9mm (2.95")	φ=5mm (0.20") L=18.5mm (0.73")	Front: D16*D5*T5 Rear: D13*D5*T4	4	477g	1/8th Truck, Monster truck
QUICRUN 4268SL 2600KV G2	2600KV	3-4S	6.1A	φ=42mm (1.65") L=68.4mm (2.69")	φ=5mm (0.20") L=18.5mm (0.73")	Front: D16*D5*T5 Rear: D13*D5*T4	4	417g	1/8th Buggy & 1/10th Monster truck

QUICRUN 4268SL-G2

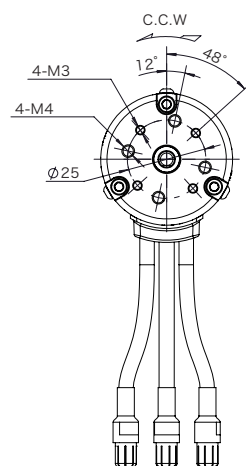
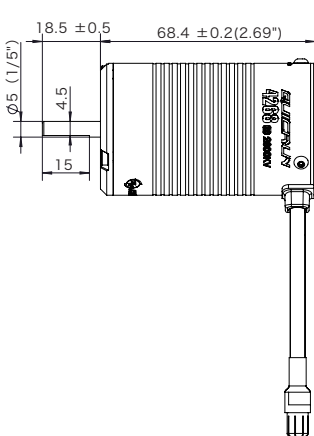
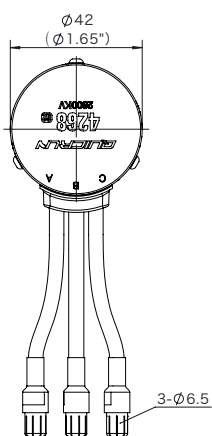

QUICRUN 4274SL-G2

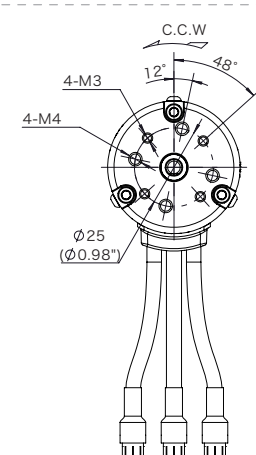
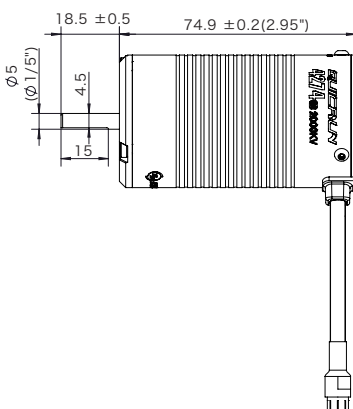
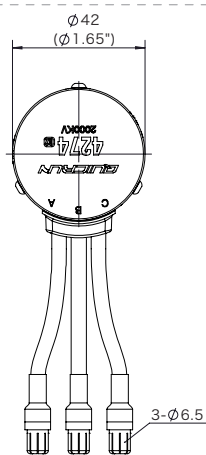

03 Installation & Connection

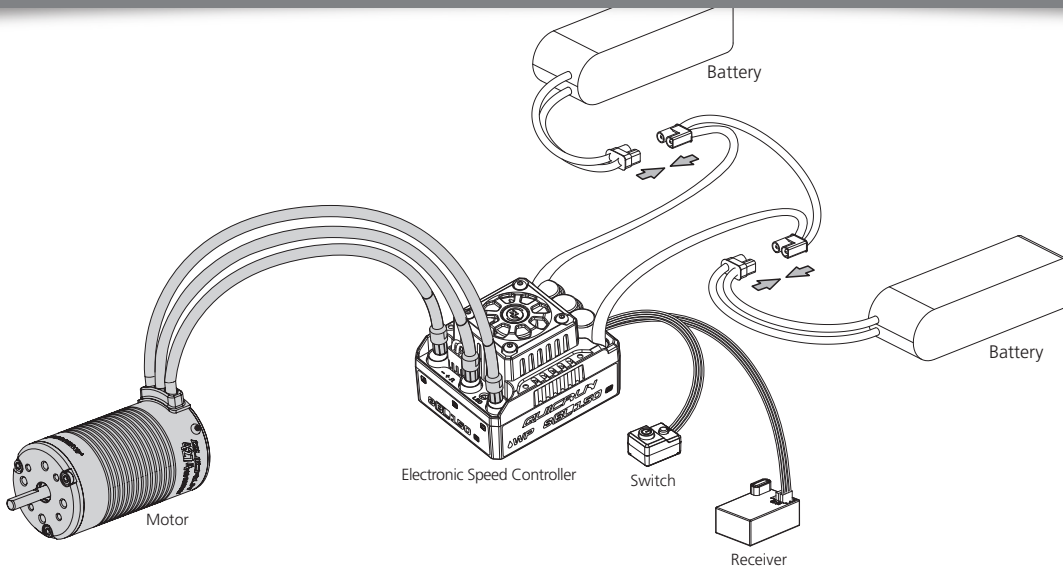

1. Installation of the motor

The motor has four M3 and four M4 mounting holes, and the mounting holes are 5.5mm in depth, before installing the motor on the vehicle, please carefully confirm whether the specification of the screws is appropriate according to the thickness of the motor mounting plate to avoid damage to the motor due to too long screws.

2. How to Connect the Motor to an ESC

There is no specific wire sequence requirement for the connection between the motor and the esc, the # A/# B/# C three wires of the motor and esc can be connected at will, if the motor rotation in the opposite direction, you can exchange any two wires.

3. Inspection

Before powering on the esc, please check the motor installation and the order of all connections.

04 Gearing

Reasonable selection of gear ratio is very important. Improper gear ratio may cause damage. You can select the gear ratio according to the following points!

1. The operating temperature of the motor

The motor temperature should be lower than 100 degrees Celsius (212 degrees Fahrenheit) in operation. High temperature may cause the magnets to get demagnetized, the coil to melt and short circuit, and the ESC to get damaged. A suitable gearing ratio can effectively prevent the motor from overheating.

2. The principle of selecting gear ratio

To avoid the possible damage to ESC and motor caused by the overheating, please start with a small pinion/a big FDR and check the motor temperature regularly. If the motor and ESC temperature always stays at a low level during the running, you can change a larger pinion/a lower FDR and also check the motor temperature regularly to ensure that the new gearing is suitable for your vehicle, local weather and track condition. (Note: For the safety of electric devices, please check the ESC and motor temperature regularly.)

05 Assembly and Disassembly

In order to make the motor have longer service life and higher efficiency, we suggest to regularly check the bearing and clean the dirt in the motor. The specific time depends on the frequency of using the motor and the site conditions. When installing, please follow the steps in the following assembly drawing; when disassembling, follow the reverse steps.

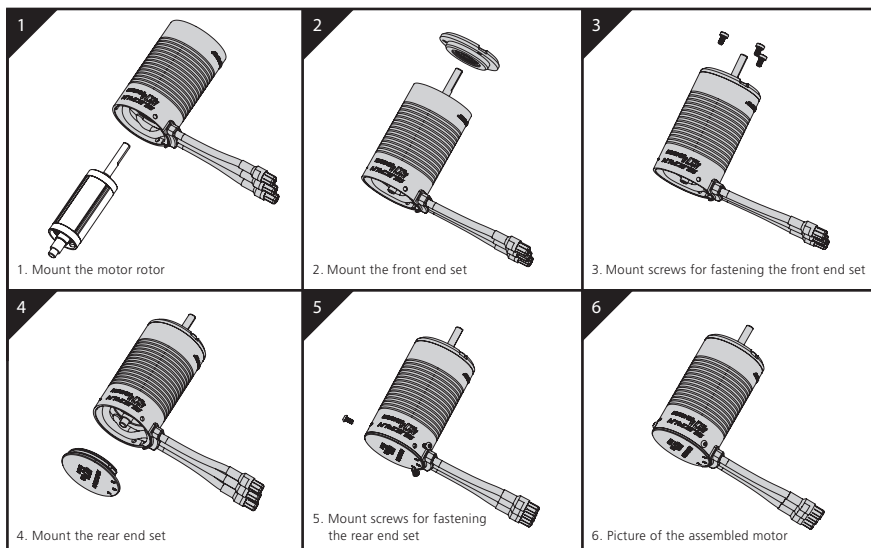

Parts List

