

# USER MANUAL

## FLYFUN V5

Brushless Electronic Speed Controller  
30A - 40A - 60A - 80A - 120A - 110A HV  
110A HV / OPTO - 130A HV / OPTO - 160A HV / OPTO

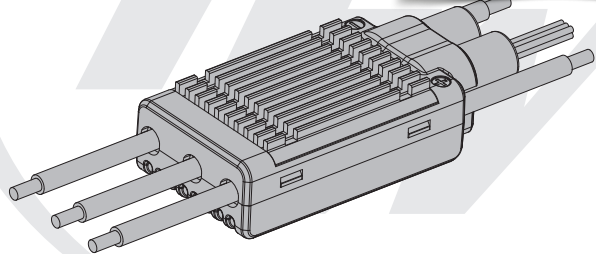

20180712



Thank you for purchasing this HOBBYWING product! Brushless power systems can be very dangerous. Any improper use may cause personal injury and damage to the product and related devices. We strongly recommend reading through this user manual before use. Because we have no control over the use, installation, or maintenance of this product, no liability may be assumed for any damages or losses resulting from the use of the product. We do not assume responsibility for any losses caused by unauthorized modifications to our product. Besides, we have the right to modify our product design, appearance, features and usage requirements without notification. We, HOBBYWING, are only responsible for our product cost and nothing else as result of using our product.

## 01 Warnings

- Read through the manuals of all power devices and aircraft and ensure the power configuration is rational before using this unit.
- Ensure all wires and connections are well insulated before connecting the ESC to related devices, as short circuit will damage your ESC.
- Ensure all devices are well connected, in order to prevent poor connections that may cause your aircraft to lose control or other unpredictable issues like damage to the device. If necessary, please use a soldering iron with enough power to solder all input/output wires and connectors.
- Never get the motor locked up during high-speed rotation, otherwise the ESC may get destroyed and may also get your motor damaged. (Note: move the throttle stick to the bottom position or disconnect the battery immediately if the motor really gets locked up.)
- Never use this unit in the extremely hot weather or continue to use it when it gets really hot. Because high temperature will activate the ESC thermal protection or even damage your ESC.
- Always disconnect and remove batteries after use, as the ESC will continue to consume current if it's still connected to batteries. Long-time contact will cause batteries to completely discharge and result in damage to batteries or/and ESC. This will not be covered under warranty.
- When using EDF airplanes, the "Normal Start-up" mode is not available due to the characteristics of the ducted fan & motor. If the diameter of the ducted fan is between 75mm to 90mm (90mm is not included), pls ensure to select the "Soft Start-up" or "Very Soft start-up" mode. If the diameter of the ducted fan is 90mm or above, then pls ensure to select the "Very Soft start-up" mode.

## 02 Features

- ESC which features a high performance 32-bit ARM M4 microprocessor (with a running frequency of up to 72MHz) is compatible with various brushless motors.
- Microprocessor powered by a separate DC regulator has better anti-interference performance greatly reduces the possibility of losing control.
- DEO (Driving Efficiency Optimization) Technology greatly improves throttle response & driving efficiency and reduces ESC temperature.
- Built-in high-power BEC with output voltage adjustable among 5.2V, 6.0V and 7.4V. The BEC module is separate from other circuits on the ESC, so the normal BEC output can be guaranteed (when issue like burnt power board happens) to allow users to get the aircraft back before crash. (Note: the FLYFUN 130A/160A HV OPTO V5 doesn't have this function.)
- Normal/Soft/Very Soft start-up modes are compatible with regular propeller airplanes and EDF jet airplanes (pls ensure to select the "Very Soft Start-up" mode when using EDF jet airplanes).
- Separate programming cable for connecting ESC to a LED program box and allows users to program the ESC anytime, anywhere. (For detailed info, please refer to the user manual of HOBBYWING LED program box.)
- Normal/proportional/reverse brake modes (esp. reverse brake mode) can effectively shorten the landing distance for the aircraft. (Note: the FLYFUN 130A/160A-HV-OPTO-V5 doesn't have this function.)
- Multiple protection features like start-up, ESC thermal, capacitor thermal, over-current, over-load, abnormal input voltage and throttle signal loss effectively prolong the service life of the ESC.

## 03 Specifications

Model (Regular)	Cont. Current	Peak Current	Input Voltage	BEC Output	Weight	Size (L*W*H)	
FLYFUN 30A V5	30A	45A	2-4S LiPo	5.1V / 6.0V Adjustable, Continuous / Peak Current of 3A / 7A (Switch-mode)	32g	50x25.4x12mm	
FLYFUN 40A V5	40A	60A	3-6S LiPo	5.2V/6V/7.4V Adjustable, Continuous/Peak Current of 8A/20A (Switch-mode)	44g	47x28x14mm	
FLYFUN 60A V5	60A	80A			73.5g	68.8x34.6x18mm	
FLYFUN 80A V5	80A	100A			92g	69.8x34.6x19.2mm	
FLYFUN 120A V5	120A	150A			93g	77.2x34.6x19.2mm	
Model (HV)	Cont. Current	Peak Current	Input Voltage	BEC Output	Weight	Size (L*W*H)	
FLYFUN 110A HV V5	110A	140A	6-14S LiPo	5.2V / 6.0V / 7.4V Adjustable, Continuous / Peak Current of 10A / 25A (Switch-mode)	180g	92.7x45.6x27mm	
FLYFUN 110A HV OPTO V5	110A	140A			No	170g	92.7x45.6x27mm
FLYFUN 130A HV OPTO V5	130A	160A			No	221.5g	110x50.3x33.2mm
FLYFUN 160A HV OPTO V5	160A	200A			No	221.5g	110x50.3x33.2mm

## 04 User Guide

**Attention!** The default throttle range of this ESC is from 1100µs to 1940µs (Futaba's standard); users need to calibrate the throttle range when they start to use a new FLYFUN brushless ESC or another transmitter.

### 1 Connections

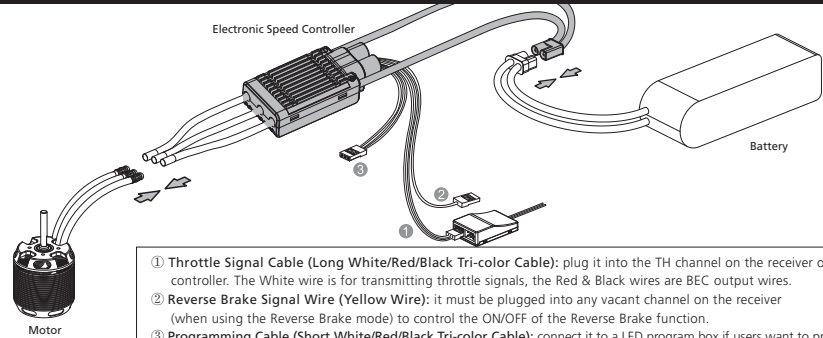

- ① Throttle Signal Cable (Long White/Red/Black Tri-color Cable): plug it into the TH channel on the receiver or flight controller. The White wire is for transmitting throttle signals, the Red & Black wires are BEC output wires.
- ② Reverse Brake Signal Wire (Yellow Wire): it must be plugged into any vacant channel on the receiver (when using the Reverse Brake mode) to control the ON/OFF of the Reverse Brake function.
- ③ Programming Cable (Short White/Red/Black Tri-color Cable): connect it to a LED program box if users want to program the ESC.

#### How to add an external cappack to the connections

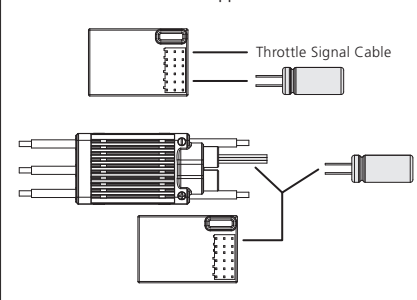

### 2 External Capacitor Module (also called Cappack) Wiring (Optional)

For the FLYFUN 80A/120A-V5, its BEC load capacity may be insufficient when using high power servos. In that case, we suggest connecting the stock external cappack to the BEC's output end (i.e. any idle channel on the receiver **\*note 1**) in parallel. Users can check if the BEC is working in overload condition by the following method: keep moving relevant throttle sticks (that control servos) to start/stop those servos and change directions quickly to see if the receiver or flight control system (if exists) will be restarted during the process. If restart occurs, then it means that the sudden load of the electronic system exceeds the BEC's output capability and an external cappack is needed.

**Note 1:** if there is no vacant channel on the receiver, then users can connect a short, thick Y cable (as thin, long cable may affect the capacitor's performance, so we don't recommend it) to the BEC's output wires in parallel.



Please carry out the mentioned test before trial flight, and keep the output signals from throttle channel at 0% throttle during the test.

### 3 ESC/Radio Calibration

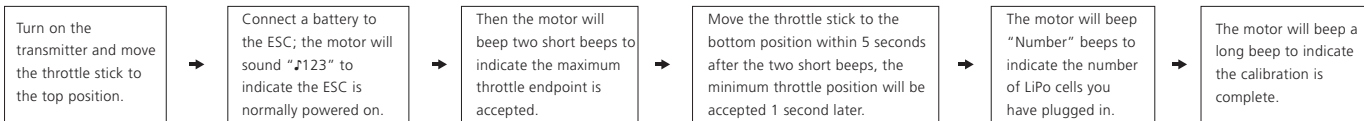

### 4 Normal Start-up Process

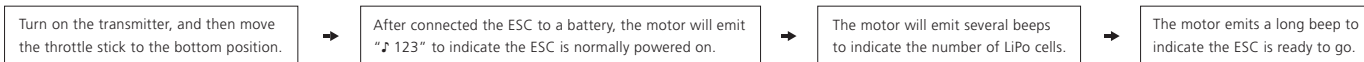

## 05 ESC Programming

There are two ways to program the ESC. One way is to program it with a LED program box; the other way is to program it with the transmitter. The ESC has many programmable items, so we recommend using the LED program box to do the ESC programming.

### 1 Program your ESC with a LED Program Box

- Plug the programming cable (on your ESC) into the programming port on the LED program box.
- (With a battery connected to your ESC), after connected a LED program box to the ESC, you need to disconnect the battery first and then reconnect it to the ESC to enter the programming mode to check and set parameters.

The portable program box is an optional accessory applicable for field use. Its friendly interface makes the ESC programming easy and quick. Connect a battery to your ESC after connecting a LED program box to the ESC, all programmable items will show up a few seconds later. You can select the item you want to program and the setting you want to choose via "ITEM" & "VALUE" buttons on the program box, and then press the "OK" button to save all new settings to your ESC.

**Attention!** You need to power your ESC off and then on after adjusting parameters. Otherwise, new parameters won't take effect.

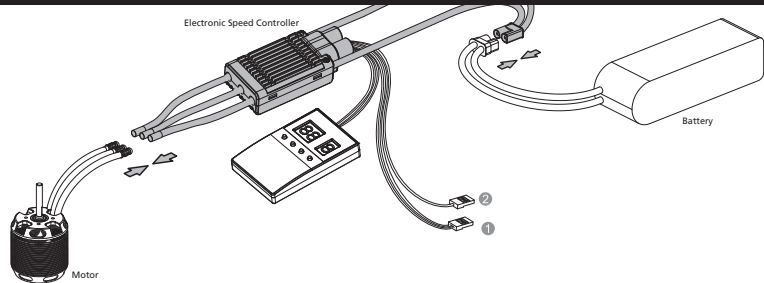

### 2 Program your ESC with the Transmitter

#### 1. Wiring:

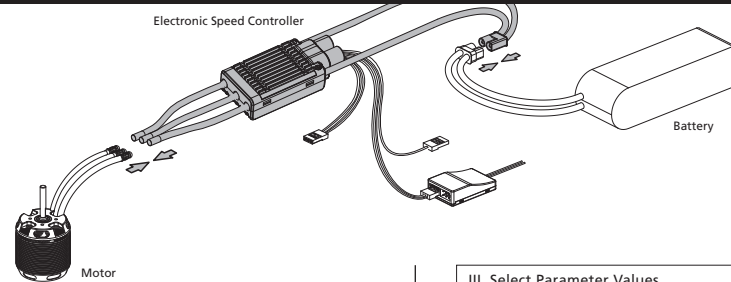

#### 2. ESC Programming via the Transmitter (Throttle Stick)

##### I. Enter the Programming

Turn on the transmitter, move the throttle stick to the top position, and connect a battery to the ESC, 2 seconds later, the motor will beep "B-B-" first, then emit "56712"5 seconds later to indicate that you are in the ESC programming mode.

##### II. Select Parameter Items

After entering the programming, you'll hear the following 12 kinds of beeps circularly. Move the throttle stick to the bottom position within 3 seconds after you hear some kind of beeps, you'll enter the corresponding parameter item.

1. "B-", Brake Type (1 Short B)
2. "B-B-", Brake Force (2 Short Bs)
3. "B-B-B-", Voltage Cutoff Type (3 Short Bs)
4. "B-B-B-B-", LiPo Cells (4 Short Bs)
5. "B-----", Cutoff Voltage (1 Long B)
6. "B-----", BEC Voltage (1 Long B & 1 Short B)
7. "B-----", Start-up Mode (1 Long B & 2 Short Bs)
8. "B-----", Timing (1 Long B & 3 Short Bs)
9. "B-----", Motor Direction (1 Long B & 4 Short Bs)
10. "B-----", Freewheeling (2 Long Bs)
11. "B-----", Factory Reset (1 Long B & 1 Short B)
12. "B-----", Exit (2 Long Bs & 2 Short Bs)

**Note:** A long "B-----" equals to 5 short "B-", so a long "B-----" and a short "B-" represent the 6th item in "Select Parameter Items".

## 06 Programmable Items

Items	Values (Bs)	1	2	3	4	5	6	7	8
1	Brake Type	Disabled	Normal	Proportional	Reverse				
2	Brake Force	Disabled	Level 1	Level 2	Level 3	Level 4	Level 5	Level 6	Level 7
3	Voltage Cutoff Type	Soft	Hard						
4	LiPo Cells	Regular	Auto Calc.	3S	4S	5S	6S		
	HV	6S	8S	10S	12S	14S			
5	Cutoff Voltage	Disabled	2.8V	3.0V	3.2V	3.4V	3.6V	3.8V	
6	BEC Voltage	5.2V	6.0V	7.4V					
7	Start-up Mode	Normal	Soft	Very Soft					
8	Timing	0°	5°	8°	12°	15°	20°	25°	30°
9	Motor Direction	CW	CCW						
10	Freewheeling	Enabled	Disabled						

**Note:** different ESCs have different default settings, please take the default settings of each ESC as the standard.)

#### 1. Brake Type

**Normal Brake:** After selected this option, the brake function will be activated when you move the throttle stick to the bottom position. In this mode, the brake amount equals to the brake force you've preset.

**Proportional Brake:** After selected this option, the throttle range of 20% to 100% (on the transmitter) will correspond to the ESC throttle output of 0% to 100% while the throttle range of 20% to 0% (on the transmitter) will correspond to the brake force of 0 to 100%.

**Reverse Brake:** After selected this option, the Reverse Brake signal wire (its signal range must be the same as the throttle range) must be plugged into any vacant channel on the receiver, and you can control the motor direction via that channel. The channel range of 0-50% is the default motor direction, the channel range of 50% to 100% will cause the motor to spin counterclockwise. The channel stick should be within the channel range of 0-50% (0 would be better) when the first time you power on the ESC. After the Reverse function is activated, the motor will stop first and then spin in the reversed direction and then increase to the speed corresponding to the throttle input. Either signal loss, no matter reverse brake signal loss or throttle signal loss during the flight, can cause the throttle signal loss protection to be activated.

#### 2. Brake Force

This item is adjustable from level 1 to level 7. The higher the level, the stronger the braking effect. It's only effect in the "Normal Brake" mode.

#### 3. Voltage Cutoff Type

**Soft Cutoff:** After selected this option, the ESC will gradually reduce the output to 50% of the full power in 3 seconds after the low-voltage cutoff protection is activated.

**Hard Cutoff:** After selected this option, the ESC will immediately cut off the output when the low-voltage cutoff protection is activated.

#### 4. LiPo Cells

The ESC will automatically calculate the number of LiPo cells you have plugged in as per the "3.7V/Cell" rule if "Auto Calc." is selected, or you can set this item manually.

#### 5. Cutoff Voltage

This item is adjustable from 2.8V to 3.8V (they are the cutoff voltages for one cell); or you can disable it if necessary.

#### 6. BEC Voltage

This item is adjustable among 5.2V, 6.0V and 7.4V.

#### 7. Start-up Mode

**Normal Start-up:** After selected this option, the motor will immediately start spinning and then quickly reach to the corresponding speed when you move the throttle stick from bottom position to top position.

**Soft Start-up:** After selected this option, the motor will slowly start spinning and then quickly reach to the corresponding speed when you move the throttle stick from bottom position to top position.

**Very Soft Start-up:** After selected this option, the motor will slowly (slower than in "Soft Start-up Mode") start spinning and then quickly reach to the corresponding speed when you move the throttle stick from bottom position to top position. We recommend selecting the "Soft Start-up" or "Very Soft Start-up" mode when you are flying an airplane with a big-sized ducted fan. Please ensure to select the "Very Soft Start-up" mode if the diameter of the ducted fan on your airplane is over 90mm.

#### 8. Timing

This item is adjustable from 0 degree to 30 degrees.

#### 9. Motor Rotation

This item allows you to adjust the rotation direction of your motor between CW and CCW.

#### 10. Freewheeling

This item is adjustable between "Enabled" and "Disabled". With it enabled, you can have better throttle linearity or smoother throttle response.

## 07 Troubleshooting & Multiple Protections

Troubles	Warning Tones	Causes	Solutions
The ESC didn't work after it was powered on while the motor kept beeping.	"BB, BB, BB....."	The input voltage was beyond the operating voltage range of the ESC.	Adjust the power-on voltage and ensure it's in the operating voltage range of the ESC.
The ESC didn't work after it was powered on while the motor kept beeping.	"B-, B-, B-, B....."	The ESC didn't receive any throttle signal from the receiver.	Check if the transmitter and receiver are well bound, if any poor connection exists between the ESC and receiver.
The ESC didn't work after it was powered on while the motor kept beeping.	"B, B, B, B....."	The throttle stick has not been moved to the bottom position.	Move the throttle stick to the bottom position and calibrate the throttle range.
The ESC didn't work after the throttle calibration while the motor kept beeping.	"B, B, B, B....."	The throttle range you set was too narrow.	Re-calibrate the throttle range.
The motor "stuttered" during the flight. It would resume the normal operation if the throttle input was below 60% but re-start to stutter if the throttle input was over 60%. The motor started to beep when it stopped spinning.	"BB, BB, BB....." or "BBBB, BBBB....."	The ESC thermal protection has been activated.	Improve the heat dissipating condition (i.e. add a cooling fan) or reduce the ESC load.
The ESC output suddenly reduced to 50% during the flight, the motor kept beeping after the flight completed but the battery was still connected to the ESC.	"BBB, BBB, BBB....."	The low-voltage cutoff protection has been activated.	Change another pack; lower down the cutoff voltage or disable the LVC protection (we do not recommend this).

#### Multiple Protections

##### 1. Start-up Protection:

The ESC will monitor the motor speed during the start-up process. When the speed stops increasing or the speed increase is not stable, the ESC will take it as a start-up failure. At that time, if the throttle amount is less than 15%, the ESC will try to restart automatically; if it is larger than 20%, you need to move the throttle stick back to the bottom position first and then restart the ESC. (Possible causes of this problem: poor connection/disconnection between the ESC and motor wires, propellers are blocked, etc.)

##### 2. ESC Thermal Protection:

The motor will "stutter" when the ESC temperature goes above 110°C to indicate that the ESC thermal protection is activated. If lower down the throttle input to below 60% at this moment, the "stuttering" will disappear and the ESC will output the corresponding power. The motor will re-start to "stutter" if the throttle input exceeds 60%. In this condition, disconnect the battery first and then re-connect it to the ESC after the ESC cools down (the ESC temperature cannot exceed 70°C, otherwise it cannot be started), it will resume the normal operation.

##### 3. Throttle Signal Loss Protection:

When the ESC detects loss of signal for over 0.25 second, it will cut off the output immediately to avoid an even greater loss which may be caused by the continuous high-speed rotation of propellers or rotor blades. The ESC will resume the corresponding output after normal signals are received.

##### 4. Overload Protection:

The ESC will cut off the power/output or automatically restart itself when the load suddenly increases to a very high value. (Possible cause to the sudden load increase is that propellers are blocked or the motor and the ESC are out of sync.)

##### 5. Over-current Protection:

The ESC will cut off the output immediately when the peak current exceeds the regulated value, and then restart to resume the output. If the current continues to go above the regulated value, then the output will be completely cut off. This protection may be activated by the burnt motor or some others.



# FLYFUN V5

## 空模无刷电子调速器

### 使用说明书

30A · 40A · 60A · 80A · 120A · 110A HV  
110A HV OPTO · 130A HV OPTO · 160A HV OPTO

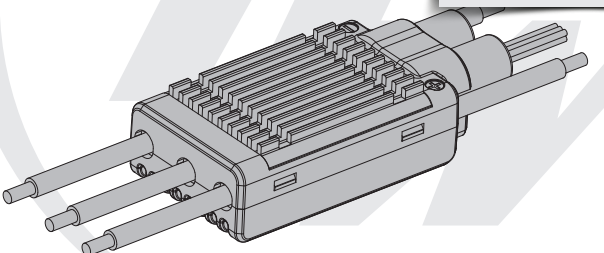

20180712

## 02 产品特点

- 使用高性能32位ARM M4微处理器, 运行频率高达72MHz, 兼容多种无刷电机。微处理器采用独立的稳压IC给供电, 具有更好的抗干扰能力, 大大降低失控的可能性。
- 采用同步整流驱动效率优化技术 (DEO—Driving Efficiency Optimization), 油门响应更快更线性, 驱动效率更高, 电调温度更低。
- 内置高效率大功率开关模式BEC, 输出电压可以通过软件在5.2V/6.0V/7.4V之间进行切换。BEC模块和电调其他电路相互独立, 当电调功率板出现烧蚀等故障时, 最大限度保证BEC正常输出, 提供救机机会; (FLYFUN 130A/160A HV OPTO V5 无此功能)
- 具有普通启动/柔和启动/超柔和启动三种启动模式, 兼容普通螺旋桨固定翼飞机及涵道飞机 (涵道飞机请务必使用超柔和启动模式)。
- 具备独立参数编程线, 用于连接LED参数设定盒进行参数设定, LED参数设定盒具有简单直观的界面, 便于您随时随地修改各项参数。(详见LED参数设定盒说明书)
- 具有普通刹车, 比例刹车, 反转刹车 (反推) 多种刹车模式, 尤其是反转刹车 (反推), 可有效缩短飞机降落距离 (FLYFUN 130A/160A-HV-OPTO-V5无此功能)。
- 具有启动保护、温度保护、电容温度保护、电流保护、过负荷保护、油门信号丢失保护、输入电压异常保护多重保护功能, 有效延长电调使用寿命。

## 03 产品规格

低压型号	持续电流	瞬时电流	输入电压	BEC	重量	尺寸 (长x宽x高)
FLYFUN 30A V5	30A	45A	2-4S LiPo	开关稳压BEC, 5.1V / 6.0V两档可调; 输出电流持续3A, 瞬间7A	32g	50x25.4x12mm
FLYFUN 40A V5	40A	60A	3-6S LiPo	开关稳压BEC, 5.2V/6V/7.4V三档可调; 输出电流持续8A, 瞬间20A	44g	47x28x14mm
FLYFUN 60A V5	60A	80A			73.5g	68.8x34.6x18mm
FLYFUN 80A V5	80A	100A			92g	69.8x34.6x19.2mm
FLYFUN 120A V5	120A	150A			93g	77.2x34.6x19.2mm
高压型号	持续电流	瞬时电流	输入电压	BEC	重量	尺寸 (长x宽x高)
FLYFUN 110A HV V5	110A	140A	6-14S LiPo	开关稳压BEC, 5.1V / 6.0V / 7.4V三档可调; 输出电流持续10A, 瞬时25A	180g	92.7x45.6x27mm
FLYFUN 110A HV OPTO V5	110A	140A		无	170g	92.7x45.6x27mm
FLYFUN 130A HV OPTO V5	130A	160A		无	221.5g	110x50.3x33.2mm
FLYFUN 160A HV OPTO V5	160A	200A		无	221.5g	110x50.3x33.2mm

## 04 使用向导

**注意:** 电调的油门行程出厂默认值为1100μs—1940μs (Futaba标准), 当首次使用电调或者更换其他遥控器使用时, 均应重新设定油门行程。

### 1 接线示意图

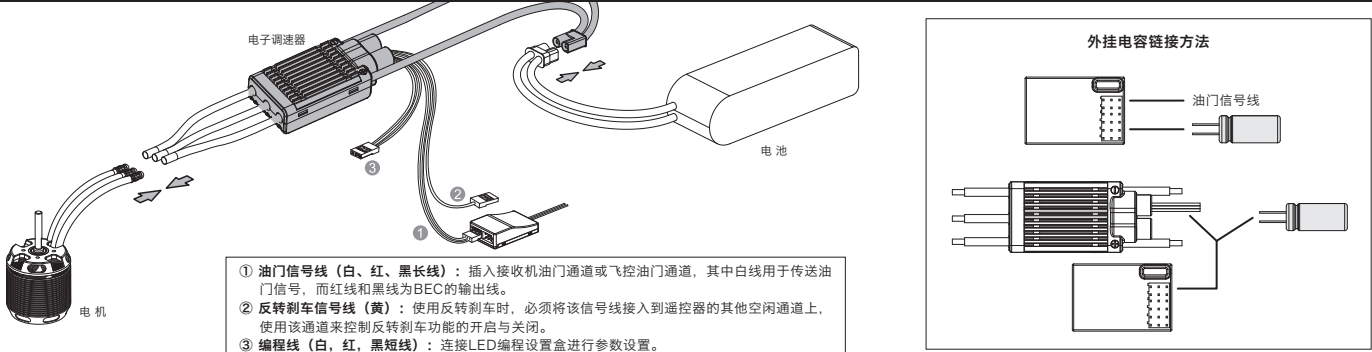

### 2 BEC连接外挂电容 (非必选项)

对于FLYFUN 80A/120A-V5电调, 使用功率较大的舵机时, 现有BEC负载能力可能出现不足, 建议将标配的外挂电容并联在BEC输出端 (如接收机的空闲通道 **“备注1”** 共同使用)。通过以下方法判断BEC是否过载工作: 快速来回摇动相关舵机控制摇杆, 使舵机快速启停与切换方向, 观察接收机或飞行控制系统 (若有) 是否在此过程中重启, 若出现重启, 则说明电子系统的瞬间负载已超过BEC的输出能力, 请使用此外挂电容。

**备注1:** 若无空闲通道, 可以使用较粗的Y线 (较细且长的Y线会影响电容性能, 不建议使用) 并联在电调的BEC输出线上。

**警告!** 以上测试请在试飞前进行, 测试过程中请保持油门通道输出信号为0%油门或以下。

### 3 油门行程校准操作方法



### 4 正常开机过程



## 05 参数设定方法

电调参数设定方法有两种:

- 通过LED参数设定盒进行参数设定;
  - 通过遥控器进行参数设定。
- 编程设定卡体积小, 适合外场使用。其界面直观, 参数读取和设定过程十分简单快捷, 且设置项较多。所以我们建议您使用LED参数设定盒进行参数设定。

### 1 通过LED参数设定盒进行参数设定 (详见LED参数设定盒说明书)

1.接线示意图:

- 将电调编程线连接至LED参数设定盒编程线接口。
- 电调上电 (已通电的需断开电源重新上电), 电调进入参数设置模式, 读取、设定电调参数。

2.参数设定方法:

- 电调和LED参数设置盒连接后, 给电调接上电源, 数秒后该电调的各项参数即可显示出来。
- 选择LED参数设置盒上的“ITEM”键可选择编程项目;
- 选择“VALUE”按键设置该编程项目下的参数值;
- 按“OK”键保存新参数到电调内部。

**注意:**

更改任意参数设定值后, 电调均需重新上电, 新的参数设定值才可生效。

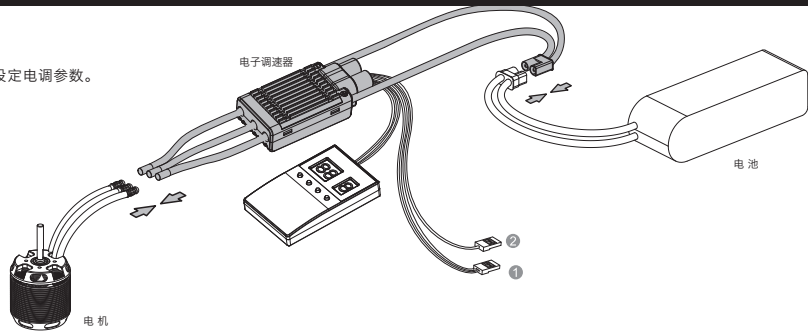

感谢您购买本产品! 无刷动力系统功率强大, 错误的使用可能导致人身伤害和设备损坏, 为此的我们强烈建议您在设备前仔细阅读本说明书, 并严格遵守规定的操作程序。我们不承担因使用本产品或擅自对产品进行改造所引起的任何责任, 包括但不限于对附带损失或间接损失的赔偿责任。我们有权在不经通知的情况下变更产品设计、外观、性能及使用要求。



## 01 注意事项

- 使用此电调前, 请认真查看各动力设备以及飞行器说明书, 确保动力搭配合理, 避免因错误的动力搭配导致电机超载, 最终损坏电调。
- 电调装入飞行器后, 使用飞行器前, 请确保所有电线和连接部件绝缘良好, 短路将会损坏电调。请务必仔细连接好各部件, 若需对电调的输入输出线、插头做相关焊接时, 为保证焊接牢靠, 请使用足够功率的焊接设备进行焊接。若连接不良, 您可能无法正常控制飞行器, 或出现设备损坏等其他不可预知的情况。
- 电调使用过程中, 请勿将电机堵转, 否则将会损坏电调并且可能导致电机损坏。如因特殊原因导致电机堵转, 请立刻将油门归零, 或者拔掉电池。
- 勿使电调置于高温环境中或者由于电调自身发热导致温度过高的情况下使用或继续使用, 高温将会触发电调温度保护, 严重时将损坏电调。
- 使用完毕后, 切记断开电池与电调的连接。如电池未断开, 电调有可能会误驱动电机转动, 造成不可预知的危险, 若长时间连接电池, 电池最终会被完全放电, 进而导致电池或电调出现故障。
- 使用在涵道飞机上时, 由于涵道扇叶和电机特性, 无法使用普通启动模式, 75mm-90mm (不包括90mm) 尺寸涵道飞机请务必使用柔和启动模式或者超柔和启动模式, 90mm及其以上尺寸涵道涵道飞机请务必使用超柔和启动模式。

## 2 通过遥控器进行参数设定

1.接线示意图:

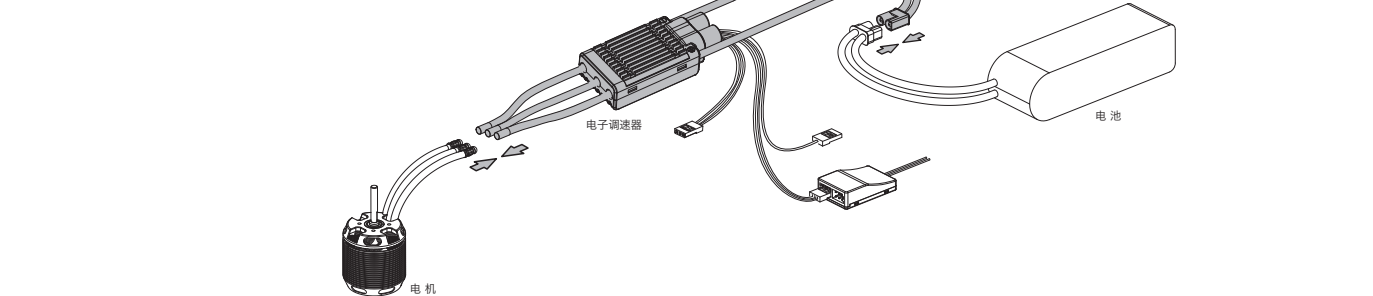

2.参数设定方法:

使用遥控器油门摇杆设定参数分为四个步骤: 进入编程模式 → 选择设定项 → 改变设定项下的参数值 → 退出。

**第一步: 进入编程模式**

开启遥控器, 将油门打到最高, 电调接上电池, 等待2秒, 鸣叫“哔-哔-”提示音, 再等待5秒, 会鸣叫“56712”特殊提示音, 表示已经进入编程模式。

**第二步: 选择参数项目**

进入编程设定后, 会听到12种鸣叫声, 按如下顺序循环鸣叫, 在鸣叫某个提示音后, 3秒内将油门打到最低, 则进入该设定项。

- “哔”, 刹车类型 (1短音)
- “哔-哔-”, 刹车力度 (2短音)
- “哔-哔-哔-”, 低压保护模式 (3短音)
- “哔-哔-哔-哔-”, 锂电池节数 (4短音)
- “哔——”, 低压保护阈值 (1长音)
- “哔——哔-”, BEC输出电压 (1长1短音)
- “哔——哔-哔-”, 启动模式 (1长2短音)
- “哔——哔-哔-哔-”, 进角 (1长3短音)
- “哔——哔-哔-哔-哔-”, 电机转向 (1长4短音)
- “哔——哔——”, 同步整流开关 (2长音)
- “哔——哔——哔-”, 恢复出厂默认值 (2长1短音)
- “哔——哔——哔-哔-”, 退出 (2长2短音)

**注: 一长音“哔——”相当于5声短音“哔-”, 所以在第二步“选择设定项”中, 一长一短“哔——哔-”表示第6选项。**

**第三步: 改变参数值**

马达会循环鸣叫, 在鸣叫某个提示音后将油门摇杆打到最高点, 则选择该提示音所对应的参数值, 接着鸣叫特殊提示音“1515”, 表示该参数值已被保存。退回第二步选择参数项目, 再选择其它参数项目。

参数值 (提示音)	“哔” 1短声	“哔哔” 2短声	“哔哔哔” 3短声	“哔哔哔哔” 4短声	“哔——” 1长声	“哔——” 1长1短	“哔——哔” 1长2短	“哔——哔哔” 1长3短
1 刹车类型	无刹车	普通刹车	比例刹车	反转刹车				
2 刹车力度	关闭	1级	2级	3级	4级	5级	6级	7级
3 低压保护模式	软关断	硬关断						
4 锂电池节数	自动计算	3节	4节	5节	6节			
5 低压保护阈值	关闭	2.8V	3.0V	3.2V	3.4V	3.6V	3.8V	
6 BEC输出电压	5.2V	6.0V	7.4V					
7 启动模式	普通	柔和	超柔和					
8 进角	0°	5°	8°	12°	15°	20°	25°	30°
9 电机转向	正转	反转						
10 同步整流开关	开	关						

**第四步: 退出设定**

当电机鸣叫12. “哔——哔——哔-哔-” (即第12个设定项) 两长音后, 3秒内将油门打到最低点, 则退出设定。马达发出N声短鸣音“哔-”, 表示锂电池节数, 随后马达发出一声长鸣音“哔——”, 表示系统准备就绪。

## 06 可编程参数项目及其说明

参数项目	参数值	1	2	3	4	5	6	7	8
1 刹车类型	无刹车	普通刹车	比例刹车	反转刹车					
2 刹车力度	关闭	1级	2级	3级	4级	5级	6级	7级	
3 低压保护模式	软关断	硬关断							
4 锂电池节数	低压	自动计算	3节	4节	5节	6节			
	高压		6节	8节	10节	12节	14节		
5 低压保护阈值	关闭	2.8V	3.0V	3.2V	3.4V	3.6V	3.8V		
6 BEC输出电压	5.2V	6.0V	7.4V						
7 启动模式	普通	柔和	超柔和						
8 进角	0°	5°	8°	12°	15°	20°	25°	30°	
9 电机转向	正转	反转							
10 同步整流开关	开	关							



不同的电调默认设置不一样, 请以电调默认设置为准。

可编程参数说明:

1. 刹车类型:

- 普通刹车: 油门归零以后, 触发刹车, 刹车力度为设定的刹车力度;
- 比例刹车: 遥控器上的油门行程20% - 100%对应电调油门输出0%-100%, 遥控器上的油门行程20%-0%对应刹车力度0-100%;
- 反转刹车 (反推): 开启反转刹车功能后, 须将反转刹车信号线 (信号范围和油门行程一致) 插入到接收机的一个空闲通道上, 通过该通道控制电机正反转, 通行程0-50%为电机默认设置转向, 通行程50%-100%触发电机反转。初次上电该通道摇杆所处位置必须在该通行程0-50%范围内 (最好为0)。触发反转时, 电机先刹停, 再反转加速至油门摇杆输出的油门量, 运行过程中反转刹车信号线与油门线其中任何一个信号丢失都会触发油门信号丢失保护。

2. 刹车力度:

1-7级, 等级越高刹车力度越大 (即螺旋桨由旋转到停止的时间越短); 该功能仅在普通刹车模式下有效。

3. 低压保护模式:

软关断: 触发低压保护后3秒内输出功率将逐渐降低为总功率的50%;

硬关断: 立即断开输出。

4. 锂电池节数:

选择自动计算, 将按单节电池3.7V计算电池节数, 也可手动设置电池节数。

5. 低压保护阈值:

设置关闭则低电压保护关闭, 其他6级为低压保护模式的保护电压值, 该值为单节电池的电压。

6. BEC输出电压: 5.2V, 6.0V, 7.4V三档可调。

7. 启动模式:

- 普通: 推动油门摇杆以后电机机会立即启动并快速达到相应的油门值;
  - 柔和: 推动油门摇杆以后电机机会先缓慢启动然后再快速达到相应的油门值;
  - 超柔和: 推动油门摇杆以后电机机会以更柔和更慢的速度启动, 然后再快速达到相应的油门值;
- 使用较大尺寸涵道飞机时, 请务必使用柔和或超柔和启动模式, 90mm以上尺寸涵道飞机请务必使用超柔和启动模式。

8. 进角:

可以调节驱动电机的进角值, 8级可调。

9. 电机转向:

正转/反转, 连接设定盒更改该项参数可改变电机转向。

10. 同步整流:

固定为开启, 开启同步整流将带来更好的油门线性。

## 07 故障及保护功能说明

一、故障处理:

故障描述	提示音	说明	解决办法
电调通电以后不工作, 鸣叫报警	“哔哔, 哔哔, 哔哔, 哔哔, ……”	输入的电压不在电调的工作电压之内。	调节通电压至电调的工作电压范围内
电调通电以后不工作, 鸣叫报警	“哔-, 哔-, 哔-, 哔-, ……”	油门信号丢失。	接入油门信号
电调通电以后不工作, 鸣叫报警	“哔, 哔, 哔, ……”	油门摇杆没有归零。	油门摇杆归零, 进行油门行程校准
进行油门行程校准后, 电调不工作, 鸣叫报警	“哔, 哔, 哔, ……”	所设定油门总行程过窄 (电调设计时, 要求油门总行程不得小于三格油门), 本次行程设定无效。	重新进行油门行程校准
飞行过程中电机出现“打嗝”现象, 油门低于60%恢复正常, 高于60%再次“打嗝”。电机转后鸣叫报警	“哔哔、哔哔、哔哔……” 或“哔哔哔哔、哔哔哔哔……”	触发电调温度保护。	改善散热 (添加散热风扇), 降低电调负载
飞行过程中电调输出功率突然下降至50%, 停止飞行后不断电情况下, 鸣叫报警	“哔哔哔, 哔哔哔, 哔哔哔, ……”	触发电调低压保护。	更换电池 降低低压保护阈值或关闭低电压保护 (不推荐)

二、保护功能说明:

- 启动保护:** 启动过程中, 电调会检测电机转速, 当转速出现停止上升或者转速提升不稳定的情况, 则判断启动失败, 若此时油门小于15%, 电调会自动尝试重新启动; 若此时油门大于20%, 需将油门归零后重新启动。(出现这种情况的原因可能有: 电调和马达连续接触不良或有别个输出线断开、螺旋桨被其他物体阻挡、减速齿卡死等)
- 温度保护:** 当电调检测到油门遥控信号丢失0.25秒以上即立即关闭输出, 以免因螺旋桨继续高速转动而造成更大的损失。信号恢复后, 电调也随即恢复相应的功率输出。电调断电冷却后重新上电恢复正常, 上电时电调温度不可超过70度, 否则无法启动。
- 油门信号丢失保护:** 当电调检测到油门遥控信号丢失0.25秒以上即立即关闭输出, 以免因螺旋桨继续高速转动而造成更大的损失。信号恢复后, 电调也随即恢复相应的功率输出。
- 过负荷保护:** 当负载突然变得极大时, 电调会切断动力, 或自动重新启动。(出现这种情况的原因通常是螺旋桨堵转或者电机失步。)
- 电流保护:** 瞬间电流超过规定值以后, 电调会立即切断动力输出, 然后重启恢复动力输出, 若此后依旧出现电流超过规定值, 则彻底切断动力输出。(出现这种情况的原因可能有: 马达短路或负载过重。)