

FASSTest12CH(Telemetry OFF) mode

This mode is forcibly turning off telemetry transmission to prevent collision of telemetry signals from the receiver to the transmitter when using dual RX link mode in FASSTest12ch mode.

- 1 Turn on the receiver. [Transmitter is always OFF]
- 2 Press and hold the SW for 5 seconds or more.

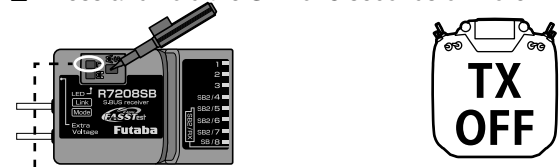

Blinking switches every 5 seconds as follows.

RED → ORANGE → GREEN → ORANGE slow blink

3 Release the switch here

Blinks ORANGE once

FASSTest12CH(Telemetry OFF) mode: OFF

Press SW once more to return to flashing orange once

FASSTest12CH(Telemetry OFF) mode: ON

4 Press switch

Blinks ORANGE twice

5 Press and hold the SW

Blinks ORANGE

6 Release SW

Solid ORANGE

7 Turn off the receiver power

Change to this mode when using FASSTest12CH in dual RX link mode.

Check	
After restarting, the LINK LED lights up.	
In FASSTest12CH Telemetry OFF Mode	
Status	LINK LED
Start	Orange Solid

How to Dual Rx Link

- 1 Install two receivers on the aircraft as shown in the connection example.
- 2 Link the two receivers using the dual receiver feature of the transmitter.

For systems without dual receiver capability, link each receiver in turn.

Transmitter in link mode

For FASSTest 18CH Select dual mode and link primary

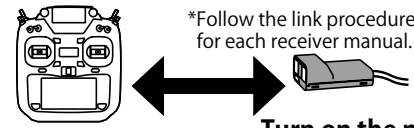

*Follow the link procedure for each receiver manual.

Turn on the main receiver and link

Transmitter in link mode
For FASSTest 18CH Select dual mode and link secondary

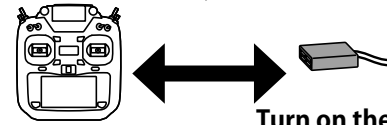

Turn on the sub receiver and link

About telemetry system

When using the dual receiver function

- The telemetry function of the main receiver can be used
- Sub-receiver telemetry function is not available

Telemetry for FASSTest12CH

In FASSTest12CH mode, after linking R7208SB in telemetry OFF mode, link the receiver you want telemetry to. (The transmitter will show the telemetry of the last linked transmitter.)

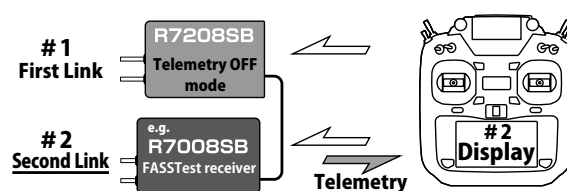
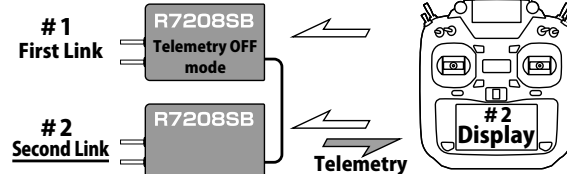

#2 Telemetry display of second-linked receiver.
#1 Telemetry OFF first-Linked receiver.

Compliance Information Statement (for U.S.A.)

This device, trade name Futaba Corporation, model number R7208SB, complies with part15 of the FCC Rules. Operation is subject to the following two conditions:
 (1) This device may not cause harmful interference, and
 (2) This device must accept any interference received, including interference that may cause undesired operation.
 CAUTION: To assure continued FCC compliance
 1. Any changes or modifications not expressly approved by the grantee of this device could void the user's authority to operate the equipment.
 2. This equipment complies with FCC radiation exposure limits set forth for an uncontrolled environment. This equipment should be installed and operated with minimum distance 20cm between the radiator & your body. The responsible party of this device compliance is:
 FUTABA Corporation of America 2681 Wall Triana Hwy Huntsville, AL 35824, U.S.A.
 Phone:1-256-461-9399 FAX:1-256-461-1059 E-mail: service@futabaUSA.com

1M23N38308

Futaba®

2.4GHz FASSTest
High Voltage System HV

R7208SB

S.BUS2 S.BUS

◆ FASSTest-2.4GHz Bidirectional Communication System

◆ Dual Rx Link System Equipment

◆ S.BUS2 / S.BUS Port and 8 Channels for Conventional System Receiver

● Applicable systems: Futaba FASSTest-2.4GHz system transmitter

Usage precaution

- Analog servos cannot be used with the R7208SB in the FASSTest 12CH mode.
- Don't connect to Extra Voltage before turning on a receiver.

WARNING

- ① Changes or modification not approved by the party responsible for compliance could void the user's authority to operate the equipment.
- ① The R7208SB receiver should be protected from vibration by foam rubber, Velcro, or similar mounting methods. Protect from moisture.
- ① Keep away from conductive materials to avoid short circuits.

Antenna installation precaution

- Do not cut or bundle the receiver antenna wire.
- ① The antennas must be mounted in such a way to assure they are strain relieved.
- ① Keep the antenna as far away from the motor, ESC and other noise sources as you possibly can.
- Do not touch the antenna to metal, carbon, or other conductive material.
- ① Be sure that the two antennas are placed at 90 degrees to each other.
- The R7208SB has two antennas. In order to maximize signal reception and promote safe modeling Futaba has adopted a diversity antenna system. This allows the receiver to obtain RF signals on both antennas and fly problem-free.

Thank you for purchasing a Futaba R7208SB FASSTest-2.4GHz compatible receiver. The R7208SB receiver features bi-directional communication with a FASSTest Futaba transmitter using the S.BUS2 port. Using the S.BUS2 port an impressive array of telemetry sensors may be utilized. It also includes both standard PWM output ports (1-8ch) and S.BUS output ports. The R7208SB can also be switched to the Dual Rx Link System. This system can ensure safety by mounting two FASSTest receivers on one aircraft.

Antenna installation for carbon fuselage

① You must leave 30mm at the tip of the antenna fully exposed. The exposed antenna should be secured so that it cannot move around or back inside of your aircraft.

Be careful of connector insertion

○ Don't connect an S.BUS servo / gyro to S.BUS2 connector.

Link precaution

- Do not perform the linking procedure while the motor's main power is connected or the engine is operating as it may result in serious injury.
- ① When the linking is complete, please cycle the receiver power and ensure the receiver is properly linked to the transmitter.
- ① Power on the system in this order: Transmitter first, followed by the receiver.
- ① If the R7208SB receiver was previously linked to another transmitter, make sure that transmitter is not operating while linking the receiver to the new transmitter.

Connector precaution

- Don't connect a connector, as shown in this figure.
- It will short-circuit, if it connected in this way. A short circuit across the battery terminals may cause abnormal heating, fire and burns.



(Typical installation)

The R7208SB has a port switching function. If SB2/4 to SB2/7 ports are also set to S.BUS2, sensors can be connected.

Extra Voltage Port
It connects with the battery for power, etc.
External voltage input cable of an option is used. The voltage of the battery can be displayed with a transmitter.

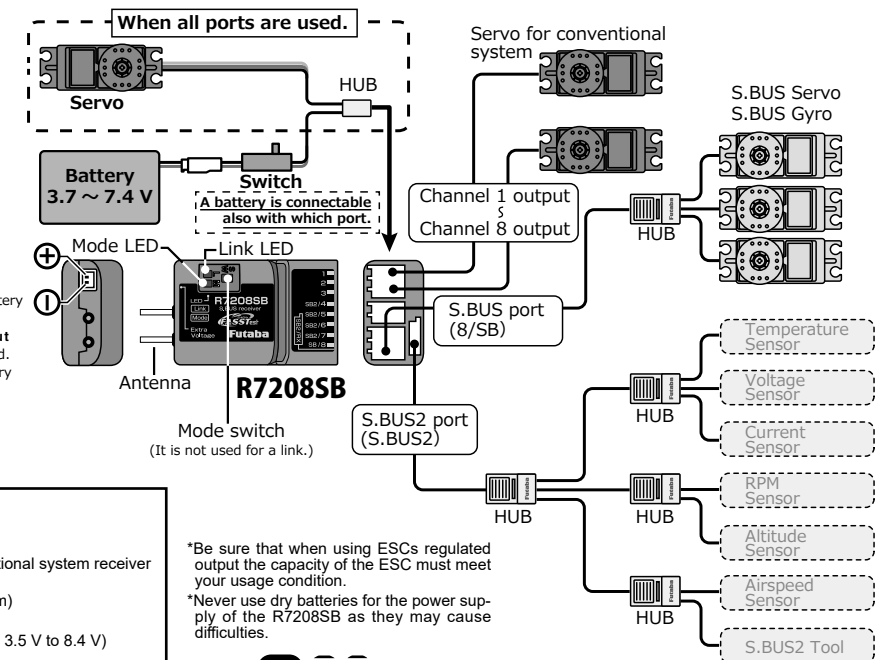

R7208SB Specifications

- FASSTest-2.4 GHz system(18 ch/12 ch mode)
- S.BUS2 and S.BUS port and 8 channels for conventional system receiver
- Dual antenna diversity
- Size: 0.98 x 1.53 x 0.56 in. (24.9 x 38.8 x 14.3 mm)
- Weight: 0.35 oz. (9.9 g)
- Power requirement: 3.7 V to 7.4 V(Voltage range: 3.5 V to 8.4 V)
- Battery F/S Voltage: It sets up with a transmitter
- Extra Voltage port: 0 ~ 70 V DC

*Be sure that when using ESCs regulated output the capacity of the ESC must meet your usage condition.
 *Never use dry batteries for the power supply of the R7208SB as they may cause difficulties.



FUTABA CORPORATION

Hobby Radio Control Business Center Sales & Marketing Department

1080 Yabutsuka, Chosei-mura, Chosei-gun, Chiba-ken, 299-4395, Japan TEL: +81-475-32-6051, FAX: +81-475-32-2915 ©FUTABA CORPORATION 2022, 12 (1)

LED Indication

Status	LINK LED
No signal reception	Red Solid
Receiving signals	Green Solid
Waiting for link	Start → 2second later → Red Blink (3 second)
Unrecoverable error (EEPROM, etc.)	Red Green Alternate blink

In Dual RX Link Mode

Status	MODE LED
External receiver is receiving error or not connected. S.BUS signal not received	Red Solid
S.BUS signal reception from external receiver (also received by external receiver)	Green Solid

In FASSTest12CH Telemetry OFF Mode

Status	LINK LED
Start	Orange Solid

Link

FASSTest is a bidirectional communication system between the R7208SB receiver and FASSTest capable transmitters. Multiple optional telemetry sensors may be connected to the S.BUS2 on the receiver and that data is in turn displayed on the transmitter.

Link to the transmitter

- Bring the transmitter and the receiver close to each other, within 20 inches (half meter).
- Turn on the transmitter. Place the transmitter into the receiver linking mode.
- Turn on the receiver.
- The receiver will wait for the linking process to begin for 2 seconds. Following that it will return to the normal operation mode.
- When the LED of the receiver changes from blinking red to solid green, linking is complete.
(A link waiting state is ended in 3 second.)

- Refer to the transmitter's operation manual for complete details on how to place the transmitter into the linking mode.
- If there are many FASSTest systems turned on in close proximity, your receiver might have difficulty establishing a link to your transmitter. This is a rare occurrence. However, should another FASSTest transmitter/receiver be linking at the same time, your receiver could link to the wrong transmitter. This is very dangerous if not noticed. To avoid the problem, we strongly recommend that you double check whether your receiver is really under control by your transmitter.
- If the System Type of the transmitter is changed, the receiver will need to be re-linked to the transmitter.

S.BUS2

S.BUS2 extends S.BUS and supports bidirectional communication. Sensors are connected to the S.BUS2 port.

Compliance Information Statement (for Canada)

This device complies with Industry Canada license-exempt RSS standard(s). Operation is subject to the following two conditions: (1) this device may not cause interference, and (2) this device must accept any interference, including interference that may cause undesired operation of the device. This equipment complies with IC radiation exposure limits set forth for an uncontrolled environment. This equipment should be installed and operated with minimum distance 20cm between the radiator & your body.
 French: Cet appareil radio est conforme au CNR-210 d'Industrie Canada. L'utilisation de ce dispositif est autorisée seulement aux deux conditions suivantes : (1) il ne doit pas produire de brouillage, et (2) l'utilisateur du dispositif doit être prêt à accepter tout brouillage radioélectrique reçu, même s'il est susceptible de compromettre le fonctionnement du dispositif. Cet équipement est conforme aux limites d'exposition aux rayonnements IC établies pour un environnement non contrôlé.
 Cet équipement est conforme aux limites d'exposition aux rayonnements IC établies pour un environnement non contrôlé. Cet équipement doit être installé et utilisé avec un minimum de 20 cm de distance entre la source de rayonnement et votre corps.

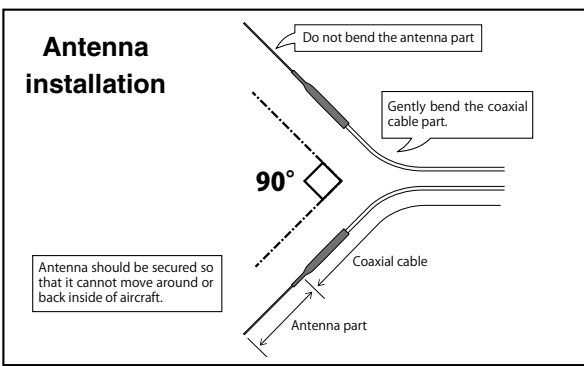

Channel Modes

The R7208SB is capable of changing its channel allocations as described in the table below. This is especially important when using the receiver in a dual receiver mode. See your transmitter operation manual for complete details on operating in the dual receiver mode.

R7208SB CH Mode table

Output connector	Channel						
	Mode A CH 1-8	Mode B CH 1-7	Mode C CH 1-6	Mode D CH 1-3	Mode E CH 9-16	Mode F CH 9-15	Mode G CH 9-14
1	1	1	1	1	9	9	9
2	2	2	2	2	10	10	10
3	3	3	3	3	11	11	11
SB2 / 4	4	4	4	S.BUS2	12	12	12
SB2 / 5	5	5	5	S.BUS2	13	13	13
SB2 / 6	6	6	6	S.BUS2	14	14	14
SB2 / 7	7	7	S.BUS2	S.BUS2	15	15	S.BUS2
SB / 8	8	S.BUS	S.BUS	S.BUS	16	S.BUS	S.BUS
LED blink	RED 1	RED 2	RED 3	RED 4	RED 5	GREEN 1	GREEN 2

Default

- Turn on the receiver. [Transmitter is always OFF]
- Press and hold the SW for 5 seconds to 10 seconds.
- When the LED of the receiver changes from blinking red to blinking orange, SW is released.
- The LED should now blink red two times in the patterns described in the chart below.
- Each press of the SW advances the receiver to the next mode.
- When you reach the mode that you wish to operate in, press and hold the SW for more than 2 seconds. When LED blinks in orange, it is the completion of a mode change, SW is released.
- Cycle the receiver power off and back on again after changing the Channel mode.



LINK LED
Red Solid
Start → 2second later → Red Blink (3 second)
Current CH mode display

Dual Rx Link System

By installing two receivers in one aircraft, if one receiver becomes unable to communicate, the other receiver can be operated.

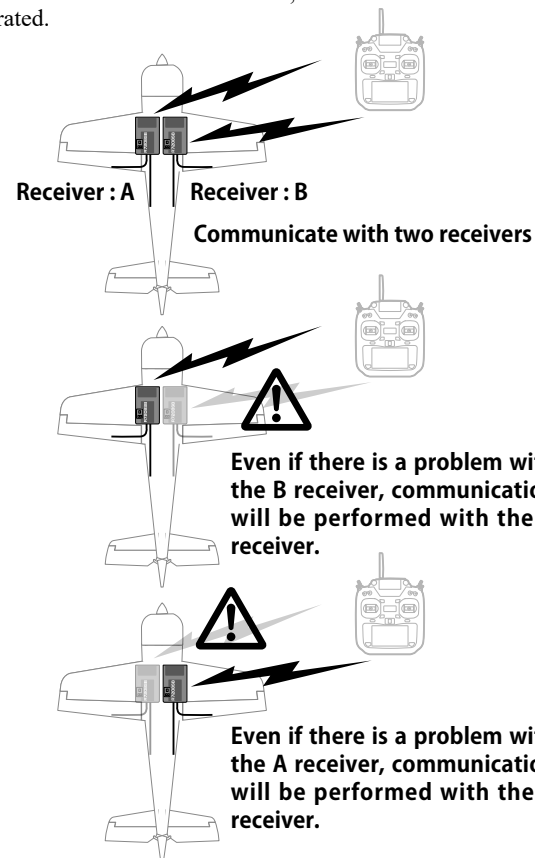

In Dual RX link mode, the SB2/RX port is for reception only, so use CH mode B, C, D, F, G mode for S.BUS output and S.BUS2 input/output.

Connection example

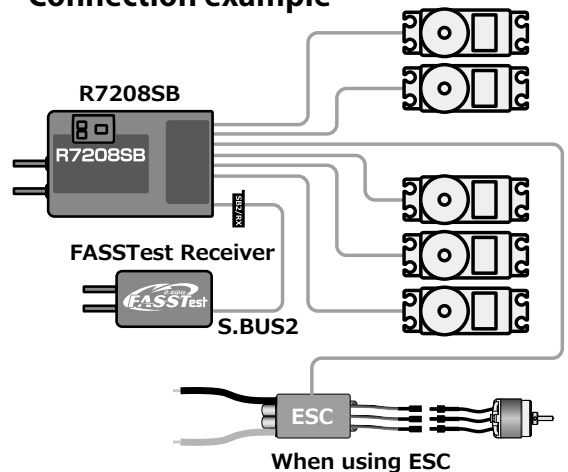

Declaration of Conformity (for EU)

Hereby, Futaba Corporation declares that the radio equipment type is R7208SB in compliance with Directive 2014/53/EU. The full text of the EU declaration of conformity is available at the following internet address: <https://www.rc.futaba.co.jp/support/manual/>

How to change to Dual RX Link mode

- Turn on the receiver. [Transmitter is always OFF]
- Press and hold the SW for 5 seconds or more.

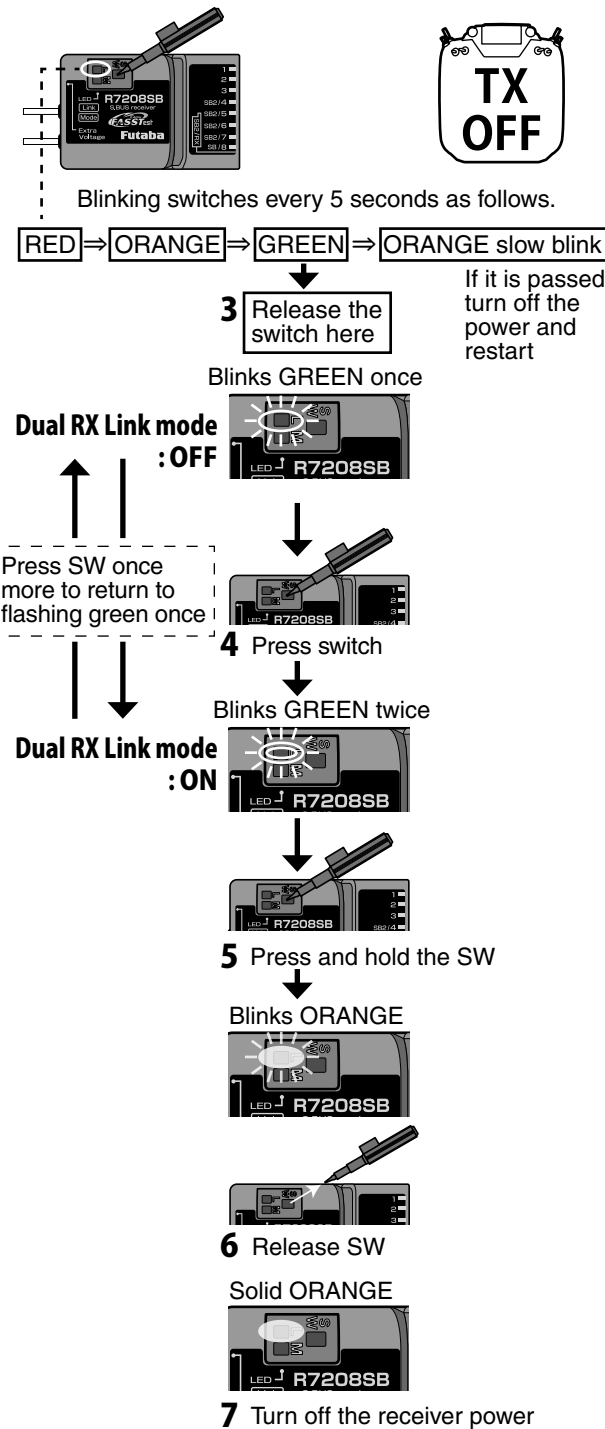

After restarting, the MODE LED lights up.

Status	MODE LED
External receiver is receiving error or not connected. S.BUS signal not received	Red Solid
S.BUS signal reception from external receiver (also received by external receiver)	Green Solid