

Futaba®

Flybarless Control Gyro

CGY760R
CGY755

Gyro Program Box

GPB-1

INSTRUCTION MANUAL

Futaba CGY760R/CGY755 is gyro, 3-axis Stabilization System combining AVCS gyro and head speed governor in one box designed for flybarless helicopters. Its cutting edge MEMS (Micro Electro Mechanical System) sensor design, ultra high-speed processing speed, and advanced PID control algorithm put it a league of it's own ahead of all ahead of all other heading hold gyros in size, weight and performance.

CGY760R has a receiver function.

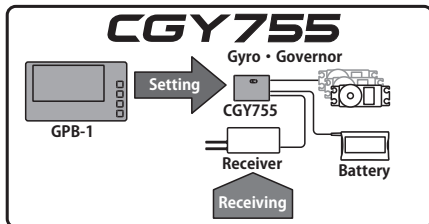
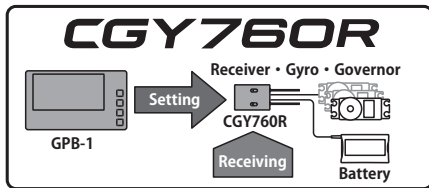

CGY755 has no receiver function.



This manual is for both **CGY760R** with receiver function and **CGY755** without receiver function.

If your gyro is **CGY755**, ignore the description of the receiver function in this dotted box.

- No part of this manual may be reproduced in any form without prior permission.
- The contents of this manual are subject to change without prior notice.
- This manual has been carefully written. Please write to Futaba if you feel that any corrections or clarifications should be made.
- Futaba is not responsible for the use of this product.

Compliance Information Statement (for U.S.A.)

This device, trade name Futaba Corporation, model number CGY760R, complies with part 15 of the FCC Rules. Operation is subject to the following two conditions:

- (1) This device may not cause harmful interference, and
- (2) This device must accept any interference received, including interference that may cause undesired operation.

CAUTION: To assure continued FCC compliance

1. Any changes or modifications not expressly approved by the grantee of this device could void the user's authority to operate the equipment.
2. This equipment complies with FCC radiation exposure limits set forth for an uncontrolled environment.

This equipment should be installed and operated with minimum distance 20 cm between the radiator & your body.

The responsible party of this device compliance is:

Futaba Service Center

2681 Wall Triana Hwy Huntsville, AL 35824, U.S.A.

TEL 1-256-461-9399 or E-mail: service@futabaUSA.com

Compliance Information Statement (for Canada)

This device complies with Industry Canada license-exempt RSS standard(s). Operation is subject to the following two conditions: (1) this device may not cause interference, and (2) this device must accept any interference, including interference that may cause undesired operation of the device. This equipment complies with IC radiation exposure limits set forth for an uncontrolled environment. This equipment should be installed and operated with minimum distance 20 cm between the radiator & your body.

French: Cet appareil radio est conforme au CNR-210 d'Industrie Canada. L'utilisation de ce dispositif est autorisée seulement aux deux conditions suivantes : (1) il ne doit pas produire de brouillage, et (2) l'utilisateur du dispositif doit être prêt à accepter tout brouillage radioélectrique reçu, même si ce brouillage est susceptible de compromettre le fonctionnement du dispositif. Cet équipement est conforme aux limites d'exposition aux rayonnements IC établies pour un environnement non contrôlé.

Cet équipement est conforme aux limites d'exposition aux rayonnements IC établies pour un environnement non contrôlé. Cet équipement doit être installé et utilisé avec un minimum de 20 cm de distance entre la source de rayonnement et votre corps.

Declaration of Conformity (for EU)

Hereby, Futaba Corporation declares that the radio equipment type is CGY760R/CGY755 in compliance with Directive 2014/53/EU. The full text of the EU declaration of conformity is available at the following internet address:

<http://www.rc.futaba.co.jp/english/dl/declarations.html>

TABLE OF CONTENTS

• Introduction	2
• Warranty and Repair Service (in U.S.A.)	5
• Features	6
• Applicable Systems	7
• Contents	8
• Replacement and Optional Items	10
• Precautions	11
• Mounting / Part name / Connecting	17
Mounting the CGY(CGY760R/CGY755)	18
Link Method With Transmitter (FASSTest / T-FHSS)	21
Connecting The CGY	22
S.BUS Channel Setting	24
Governor Installation	24
• First Map	28
• Home Screen	30
• GPB-1 Screen	33
• BASIC MENU	39
• SBUS BASIC MENU (S.BUS Basic Setting)	40
• SWH. BASIC MENU (Swash Basic Setting)	45
• FLT. TUNE MENU (Flight Tuning Setting)	53
• RUD. BASIC MENU (Rudder Gyro Basic Setting)	57
• GOV. BASIC MENU (Governor Basic Setting)	61
Governor Speed Setting	68
Governor Operation	68
• Recommended Gyro Gain Setting	69
• Adjustments During The Test Flight	69
• Tips Using The Governor With Electric Models	71
• TRANSMITTER Rotor head Gyro GAIN SET-UP	72
• EXPERT MENU	73
• RUD. EXPERT MENU (Rudder Gyro Expert Setting)	74
• FLT. EXPERT MENU (Cyclic Gyro Expert Setting)	78
• SWH. DETAIL MENU (Swash Detail Setting)	81
• GOV. EXPERT MENU (Governor Expert Setting)	88
• WRITE Screen	92
• S.BUS SERVO SETTING Screen	93
• VIA TRAINER FUNCTION	104
• 3D VIA TRAINER Screen FUNCTION LIST	105
• GPB-1 SOFTWARE UPDATE	106
• MOUNTING OF CGY760R/CGY755 WITH SCREWS	110
• Specifications	111

Technical updates and additional programming examples can be found at: www.futabausa.com



WARRANTY & REPAIR SERVICE (IN U.S.A.)

If any difficulties are encountered while setting up or operating your gyro, please consult the instruction manual first. For further assistance you may also refer to your hobby dealer or contact the Futaba Service Center at the e-mail address, fax or telephone number listed below:

Phone:1-256-461-9399, FAX:1-256-461-1059

E-Mail: service@futabaUSA.com

If you are unable to resolve the issue, pack the system in its original container with a note enclosed and a thorough, accurate description of the difficulty. Include the following in your note:

- Symptoms (including when the problem occurred)
- System (Transmitter, Receiver, Servos and model numbers)
- Model (Model name)
- Your Name, Address and Telephone number

Send the respective items to the authorized Futaba Service Center Address below:

**Futaba Corporation of America
2681 Wall Triana Hwy
Huntsville, AL 35824, U.S.A.**

- 3-Axis Gyro and Governor in one box.
- High speed operation and extremely low latencies result in greater stability.
- Low profile, small size, and light weight.
- Easy set-up and tuning the gyro and governor program using the GPB-1.
- Settings divided into Basic and Expert menus. The basic setting is for initial setting and Expert setting is for more advanced settings.
- Firmware can be updated from a Windows based personal computer when used with the optional CIU-2 or CIU-3 interface.
- S.BUS 2 compatible.
- CGY760R also has a combination of receiver functions.

• **Gyro section**

- Advanced and adaptive PID control loop is utilized.
- Simultaneous control of 3-axes (roll, pitch, yaw).

• **Rudder (yaw) section:**

- Capable of sensing angular velocity up to +/- 1,000 deg/sec.
- Compatible with 1520 μ S Analog (70 Hz), 1520 μ S Digital (280 Hz), and 760 μ S Digital (560 Hz) tail rotor servos.
- Feed Forward Option allows the CGY760R/CGY755 to consider other control functions during operation. This results in more accurate corrections and precise operation.
- Cutting edge control algorithm provides a consistent pirouette rate, precise operation, and smooth yaw control in any flight condition.

• **Aileron, Elevator (roll, pitch) section:**

- Developed specifically for flybarless helicopters.
- Supports H3-120, H3-140, H3-90, H4-00, and H4-45 swash plate types.

• **Governor section**

- Advanced and adaptive PID control loop is utilized.
- High speed operation and extremely low latencies provide a more consistent and accurate operation.
- Capable of governing head speeds from 700 rpm through 4,000 rpm
- Compatible with 1520 μ S Analog (70 Hz) and 1520 μ S Digital (280 Hz) throttle servo types.

- Feed Forward Option allows the CGY760R/CGY755 to consider other control functions during operation. This results in precise governing of the head speed.
- Governor or Revolution Limiter mode selectable.
- Supports gear ratios from 1.00 through 50.00.
- Cutting edge control algorithm provides more consistent RPM governing.
- Revolution sensor is compatible with the GV-1. The CGY760R/CGY755 also supports an optional back plate revolution sensor and brushless phase sensor.

• Receiver section

- Switch FASSTest - 2.4 GHz system and T-FHSS - 2.4 GHz system using the Gyro Program Box GPB-1 system.
- By S.BUS 2 system compatibility, it is possible to transmit the battery voltage information of the receiver and the optional sensor information connected to the S.BUS 2 port of the receiver.
- Diversity antenna system.

For CGY760R

• Other functions

- Maximum rpm memory.
- Cumulative engine operation timer.
- Integration function of engine operation time.

APPLICABLE SYSTEMS

• CGY760R

- Transmitter : Futaba FASSTest-2.4 GHz, T-FHSS Air-2.4 GHz



• CGY755

- Transmitter & Receiver : Futaba FASSTest-2.4 GHz, T-FHSS Air-2.4 GHz, FASST MULTI-2.4 GHz with S.BUS/S.BUS2

*FASST 7CH, S-FHSS is non-conforming.



Your CGY760R/CGY755 includes the following components:

Type of set

- **CGY760R / GPB-1 / Governor set**
- **CGY760R / GPB-1 set**
- **CGY760R**
- **GPB-1**

SET CONTENTS

GPB-1 Program Box				
*CGY connection cable	X	---	X	X
*Transmitter connection cable				
*Velcro tape (for attaching to transmitter)				
CGY760R				
*Mounting Pads (x3)	---	X	X	X
*Dust Covers (x3)				
Governor Sensor				
*Sensor Mounting Bracket	---	---	---	X
*Magnet (x2)				
Instruction Manual	X	X	X	X
Decal	X	X	X	X

- **CGY755 / GPB-1 / Governor set**
- **CGY755 / GPB-1 set**
- **CGY755**

SET CONTENTS

GPB-1 Program Box			
*CGY connection cable	---	X	X
*Transmitter connection cable			
*Velcro tape (for attaching to transmitter)			
CGY755			
*Mounting Pads (x3) *Receiver connection cable	X	X	X
*Dust Covers (x3)			
Governor Sensor			
*Sensor Mounting Bracket	---	---	X
*Magnet (x2)			
Instruction Manual	X	X	X
Decal	X	X	X

X: supplied ---: not supplied

GPB-1 Gyro Program Box

When setting up the gyro and the governor, connect it to the CGY760R/CGY755 and use it. Do not install it on the helicopter.



CGY760R : Has receiver function



Mounting Pads (3)



CGY755 : No receiver function



Revolution Sensor



Sensor Mounting Bracket

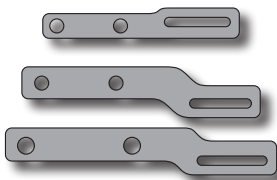

Magnets (2)



CGY Connection Cable : 350 mm

It is used to connect the CGY760R/CGY755 and the Gyro Program Box GPB-1.



Receiver Connection Cable : 100 mm

It is used to connect the CGY755 and the receiver. *Not included with CGY760R.



Transmitter Connection Cable

It is used to connect the transmitter to the Gyro Program Box GPB-1 and use the transmitter to transfer the settings of GPB-1 to the CGY760R/CGY755 wirelessly.



Dust Cover (3)



REPLACEMENT & OPTIONAL ITEMS

Futaba PC Interface CIU-2/CIU-3

Governor Revolution Sensor Set

Mounting Pad (10)

Sensor Mounting Bracket Set

Backplate Sensor BPS-1

PRECAUTIONS



Meaning of Special Markings

Pay special attention to safety where indicated by the following marks:

⚠ DANGER - Procedures which may lead to dangerous conditions and cause death/serious injury if not carried out properly.

⚠ WARNING - Procedures which may lead to a dangerous condition or cause death or serious injury to the user if not carried out properly or procedures where the probability of superficial injury or physical damage is high.

⚠ CAUTION - Procedures where the possibility of serious injury to the user is small, but there is a danger of injury, or physical damage, if not carried out properly.

 : Prohibited  : Mandatory

⚠ WARNING

Failure to follow these safety precautions may result in severe injury to yourself and others.

- Read through the entire manual before operating this product.

USAGE PRECAUTION:

- * When using FASSTest 12 CH mode, analog servo can not be used for 1-6 CH output for conventional system.
- * The FASSTest system is not compatible with the conventional FASST system.

⚠ CAUTION

 Do not mount GPB-1 (Gyro Program Box) on the helicopter.

- * It will be damaged by vibration.

ANTENNA INSTALLATION PRECAUTION:

⚠ WARNING

⚠ Be sure that the two antennas are placed at 90 degrees to each other.

*The CGY760R has two antennas. In order to maximize signal reception and promote safe modeling Futaba has adopted a diversity antenna system. This allows the receiver to obtain RF signals on both antennas and fly problem-free.

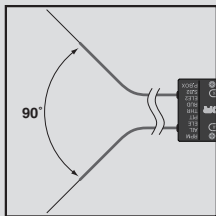

- ⊘ Do not cut or bundle the receiver antenna wire.
- ⊘ Do not bend the coaxial cable. It causes damage.
- ⊘ To prevent damage to the antenna, please exercise caution. Do not bend at the base of the antenna. Also, ensure that the unit is not subjected to impact damage.
- Ⓛ Keep the antenna as far away from the motor, ESC and other noise sources as you possibly can.

CARBON FUSELAGE PRECAUTION:

⚠WARNING

- Ⓛ You must leave 30 mm at the tip of the antenna fully exposed. The exposed antenna should be secured so that it can not move around or back inside of your aircraft.

CONNECTOR INSERTION PRECAUTION:

⚠WARNING

- ⊘ Do not connect the connector by mistake as shown on the right.



BEFORE EACH FLIGHT:

⚠WARNING

- Ⓛ Keep away from conductive materials to avoid short circuits.
- Ⓛ If it does not operate properly during operation test before use or use, stop using it.
- Ⓛ Always check the transmitter and receiver battery voltage to ensure they have enough remaining capacity to complete the flight.
- Ⓛ Confirm that the CGY760R/CGY755 is operating in the correct mode.

ABOUT BATTERIES:

⚠WARNING

- Ⓛ Newer high-end servos and other radio equipment are capable of placing large demands on the power systems in use today. When us-

ing a regulator you must ensure that the regulator is capable of supplying the current demands of the equipment you have selected. In addition to this make sure the wiring and switch you have selected are capable of handling high current draws.

*The servo current draw can be up to 50% higher on a flybarless helicopter. Always ensure your receiver battery is fully charged before each flight.

ABOUT CONNECTOR:

❗ **Insert the connector such as sensor, servo, connection cable, battery etc., surely.**

*If it is not securely inserted all the way in, it may come off due to vibration during flight and there is a danger of falling.

ABOUT WIRING:

❗ **Please secure the wiring so that it does not rub against the helicopter frame or other such items that could cause wear. If it does so, we suggest covering these areas with fuel tubing (or similar) to prevent damage.**

ABOUT VIBRATION ISOLATION AND WATERPROOFING:

❗ **The CGY760R/CGY755 is fixed with a dedicated mounting pad with good condition and the helicopter performs sufficient anti-vibration measures so as not to receive strong vibration at the time of flight. Also, if there is a risk of the gyro getting wet, place it in a plastic bag and take waterproof measures.**

ON FLIGHT PRECAUTION:

❗ **Always exit programming mode before attempting to fly the model.**

Gyro operating precautions:

⊘ **The CGY760R/CGY755 requires 5-10 seconds to initialize when the power is turned on. Do not move the helicopter and do not move the tail rotor, aileron and elevator sticks during this initialization or the gyro may not initialize properly. Once the initialization process has been completed the swash servos and tail servo will move several times indicating that the CGY760R/CGY755 is now ready for flight.**

❗ Verify that the gyros are operating and compensating in the correct direction before each flight. If the compensation direction is incorrect on any axis the model will become uncontrollable after takeoff.

❗ The servo type parameters within the CGY760R/CGY755 must match the type of servo you are using. Incorrect setting may damage the CGY760R/CGY755 or the servos, possibly resulting in a loss of control during flight.

❗ Always allow the gyro to adjust to the surrounding environmental temperature before flight. A large temperature change during use will cause drift and other operational issues.

❗ If you are switching between Normal Mode and AVCS Mode in flight, please keep in mind that you must have the gyro re-learn the center position after making a trim change within the transmitter. To memorize the new center position simply flip the gain switch on the transmitter three times between Normal Mode and AVCS Mode (Normal → AVCS → Normal → AVCS) within one second. The servo will center indicating that the new center position has been memorized.

❗ When operating the gyro in AVCS Mode, all compensation and revolution mixing must be disabled and any tail rotor or swash offsets for flight modes must be disabled.

❗ Do not drop the CGY760R/CGY755 onto a hard surface or subject the CGY760R/CGY755 sensor to a strong shock as this may damage the sensor.

❗ Verify that the gyro is operating in the desired mode.

❗ When the CGY760R/CGY755 is operated in AVCS mode the tail rotor or swash plate servos will not center when tail rotor, aileron or rudder stick is released. This is normal operation for AVCS mode. The servos may also move to the extent while the model is being carried out to the flight line. Before take off, you must visually center the tail rotor pitch slider and level the swash plate by using the transmitter control sticks. You can also center the servos by moving the tail rotor stick full left,

then full right, back to full left and then allow the stick to center within one second; the same method applies for aileron and elevator servos.

⚠ WARNING

⊖ Never turn off the CGY760R/CGY755 while the GX (gyro) LED is blinking green at high speed (about 5/sec).

*If the power is turned off while high-speed blinking, a data error will occur and all data will be initialized. It is very dangerous to fly as it is.

Governor operating precautions: **Governor**

ⓘ When the throttle servo is connected to the CGY760R/CGY755, the battery fail-safe function within the CGY760R/CGY755 must be setup and enabled.

ⓘ Throttle fail safe function (transmitter setting): Use the fail safe function for the channel that turns the governor on and off to set the fail safe position to the point at which the governor is turned off. With this setting, when the system enters the fail safe state, the governor will be turned off, and the receiver throttle signal (fail safe position preset) will be output directly.

ⓘ When using the condition hold function on the transmitter, always set the throttle servo maximum operating point to less than the point at which the governor is activated. If this is not done the governor may activate while in condition hold.

ⓘ While preparing for flight or starting the engine, always ensure the throttle remains below the governor activation point and do not select any flight modes that may activate the governor.

ⓘ If you prefer to activate the governor while the model is still on the ground, always ensure that you have at least -1 degrees of pitch in the model before activating the governor. This negative pitch is necessary to prevent an unexpected lift off as the governor activates and the head speed increases to the desired RPM.

❗ Be sure to set the autorotation condition to the OFF side with the governor ON/OFF switch function.

❗ Periodically check the rpm sensor output to ensure proper governor operation. Due to the high level of vibration and centrifugal forces the magnet may come loose or the sensor alignment may change. Every 10th flight verify that the magnet and sensor are properly mounted.

❗ If abnormality such as vibration etc., is recognized on the aircraft side during operation, be prepared to turn off the governor immediately.

MACHINE MAINTENANCE:

⚠WARNING

❗ Even though the CGY760R/CGY755 is a high performance gyro and governor, it will be necessary to ensure that the helicopter mechanics are also in optimum operating condition. Please use the guidelines below and address all issues before installing and flying the CGY.

- The CGY must be used with a rigid tail rotor drive system. Any modern torque tube or belt drive system should be adequate. Do not attempt to fly the CGY using a wire driven tail rotor system.
- Always ensure the drive gears, torque tube, pulleys, belt, bearings and shafts are in proper working condition. If any of these items are damaged or worn they must be replaced.
- The linkage rod, tail rotor bell crank, pitch slider and tail rotor grips must operate without friction to obtain the best performance from the CGY. Binding in the tail rotor control linkage will decrease the performance of the CGY gyro and this may also shorten the servo lifespan. Please take the time now to ensure the tail rotor system on your helicopter is working correctly and without friction or binding.
- Vibration will affect the CGY's overall performance. All rotating components on the helicopter should be balanced to minimize vibrations in flight. Ensure that your engine or electric motor is running smoothly and that all vibrations have been addressed before installing and test flying the CGY.

MOUNTING / PART NAMES / CONNECTING

Mount on a model using the attached mounting pad and mount it at the center position of model gyro mount so that it is exactly parallel to the roll and pitch axis of the aircraft.

*The CGY760R/CGY755 should be mounted on a rigid platform, at least 6 in. [152 mm] away from a Nitro Engine. It is not necessary to mount the gyro near the main shaft of the model but it is very important that the mounting area chosen is rigid. Please refer to your model manufacturer's instructions for recommended mounting locations.

*Test fit the gyro sensor, ensuring that the sensor is in alignment with the model on the roll and pitch axis. The cable from the gyro sensor must exit toward the front or the rear of the model since this is the pitch axis. Any misalignment will cause a loss of performance.

Mounting angle

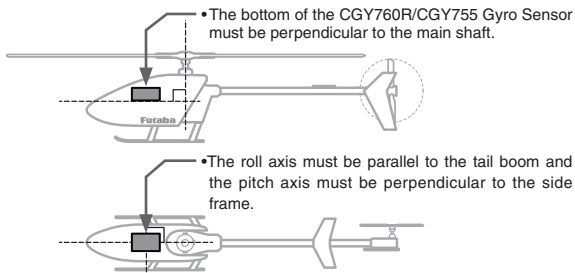

Control axis

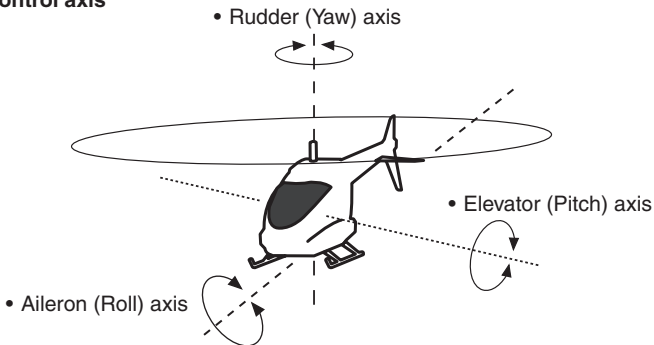

Mounting The CGY

The CGY760R/CGY755 can be mounted in the orientation shown below unless it is installed so that the roll and pitch detection axis are aligned with the model. However, if there is a deviation of , equal to, or greater than 1/2 degrees, performance will degrade. In this step, please pay special attention to ensure optimum flight performance. Refer to the installation example below and select the gyro mounting direction with "Gyro Set Dir" of the "SWH BASIC" menu.

*The surface with the "CGY" mark in the figure is the top (LED) side of the CGY.

*This is when the reverse function of each axis of the transmitter is initialized.

Gyro Set Dir--- 1

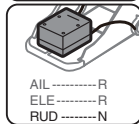
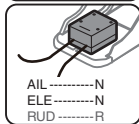
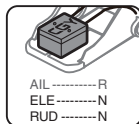
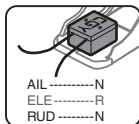
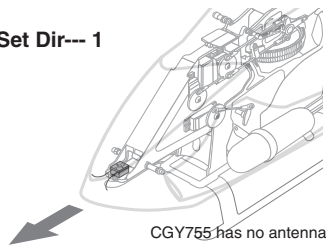

Gyro Set Dir--- 2

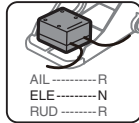
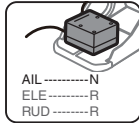
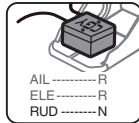
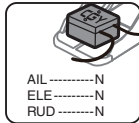
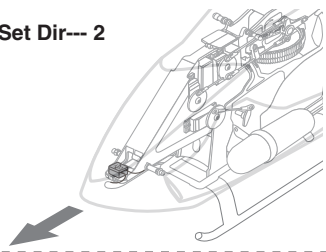

Gyro Set Dir--- 3

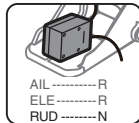
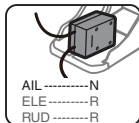
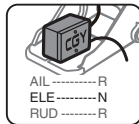
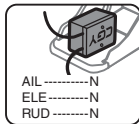
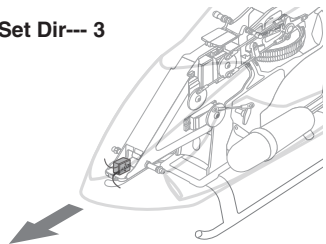

Gyro Set Dir--- 4

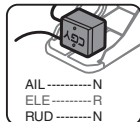
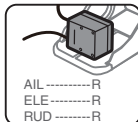
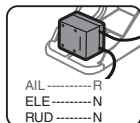
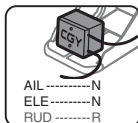
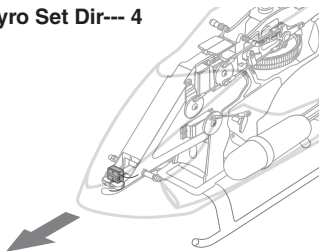

Gyro Set Dir--- 5

*Depending on the type of mounting plate, it is also possible to mount as shown in the figure.

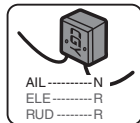
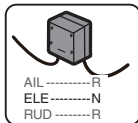
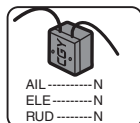
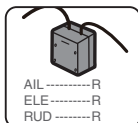
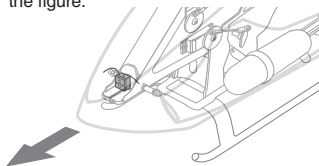

Gyro Set Dir--- 6

*Depending on the type of mounting plate, it is also possible to mount as shown in the figure.

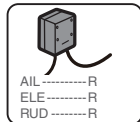
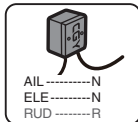
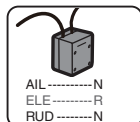
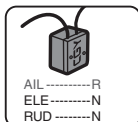

It is necessary to set the motion direction of each gyro by "AGy.Dir", "EGy.Dir" of "SWH. BASIC" menu (page 50) and "Gyro.Dir" of "RUD BASIC" menu (page 58).

AIL - Aileron (Roll) axis / ELE - Elevator (Pitch) axis / RUD - Rudder (Yaw) axis
N --- Normal / R --- Reverse

- *Make sure that the cable connection to the main body is not too tight. The excess will account for some flexibility in the model without causing stress/wear on the cable. Roughly 1.5 in. of cable slack is preferable for best performance.
- *Please install the CGY760R/CGY755 as it is in the center (vertical direction and horizontal direction) of the tape without cutting the attached mount pad. This tape is designed to effectively absorb the vibration from the model.
- *Clean the oil on the bottom of the CGY760R/CGY755 and the machine mounting part with a solvent cleaner or the like.
- *The CGY760R/CGY755 is also designed to be screwed to the gyro mount. For suggested mounting methods, please refer to page 110 of this manual.

The CGY Troubleshooting Tips

If any issues are noted during flight (such as drifting, inconsistent hold or inconsistent control rates) then please review the following troubleshooting recommendations.

1. Always verify that the tail rotor and swash plate mechanisms operate, and that the drive system is in proper working order.
2. Electromagnetic interference could be causing the problem. If you feel everything is set up correctly and that the model is vibration free, then consider moving the gyro sensor to a new location away from servos, ESC, and drive motors.
3. Vibrations will decrease the performance of all gyro systems. Even though the CGY gyro sensor is the most vibration resistant gyro sensor available, eliminating vibrations will always improve performance. The CGY gyro sensor performs best when the sensor is mounted rigidly to the airframe. It is highly recommended to avoid using soft foam pads as this may allow the gyro to bounce around on the roll and pitch axis, causing instabilities and possible loss of control during flight so that the roll and pitch sensing axis are in alignment with the model. Any misalignments over 1/2 of a degree will cause a loss in performance. Please take extra care in this step to ensure the optimum flight performance.

Using The CGY With An Electric Model

⚠ DANGER

ⓘ It is necessary to remove the pinion gear from the electric motor or disconnect the motor from the ESC before powering the model up for setup or bench testing. Electric motors are extremely powerful and capable of delivering the power instantly, causing injury to yourself, others, or the surroundings.

Once the ESC is connected to the CGY, you need to complete all necessary transmitter settings (ATV, EPA, REV, etc.) according to ESC instructions. Please refer to page 71 of this manual for further suggestions on the use of the governor of CGY760R/CGY755 and the electric model.

Link Method With Transmitter (FASSTest / T-FHSS)

For CGY760R

1. Connect the CGY760R and GPB-1 and set the same mode set in as the transmitter linking the CGY760R communication mode on the "Receiver" screen. (See page 36)
2. Keep the transmitter and receiver close to each other and turn on the receiver with the transmitter in the link mode.
3. After powering on the receiver, please allow for approximately two seconds for the binding/linking to occur.
4. The LED indication on the receiver will change from the red blinking light to a solid green. This indicates that the linking is successful. This usually occurs in approximately one second.

* Refer to the transmitters instruction manual for complete details on how to place the transmitter into the linking mode.

* If there are many T-FHSS or FASSTest systems in use when attempting to link the transmitter to the receiver, it might require more time to do so.

Additionally, if another modeler in close proximity is attempting to link their units simultaneously, it could also cause difficulties as the receiver might inadvertently link to the other transmitter. Always confirm that the receiver responds to the input from the desired transmitter.

* If the System Type of the transmitter is changed, the receiver will need to be re-linked to the transmitter. For example, if the transmitter is changed from T-FHSS to FASSTest, it will be necessary to perform the linking procedure once again.

⚠WARNING

⊘ Do not perform the linking procedure while the motor's main wire connected or the engine is operating as it may result in serious injury.

ⓘ When the linking is complete, please cycle the receiver power and ensure the receiver is properly linked to the transmitter.

ⓘ Please power up your system in this order. Transmitter first, followed by the receiver.

ⓘ If the CGY760R was previously linked to another transmitter, make sure that transmitter is not operating while linking the receiver to the new transmitter.

Connecting The CGY

GX (Gyro) LED

LED	State
Solid green	Normal operation.
Blinking green	Normal blinking (about 2/sec): S.BUS data wait time. High-speed blinking(about 5/sec): Backing up data. ⊙ Never shut down during backup.
Blinking red	Indicates an error has occurred. For example, the gyro is not functioning correctly. If normal operation does not return after cycling the power off/on once again and/or replacing the battery, please contact our customer service department.

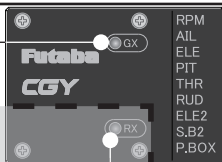

For CGY760R

RX (Receiver) LED

LED	State
Solid green	Normal operation.
Solid red	No signal reception
Red and Green turn on alternately	Unrecoverable failure (EEPROM, etc.) Cycle the power off/on once again to return to normal operation. If this is not successful, please contact our customer service center.

(9) P.BOX:

- Connect to CGY when making settings.
When setting is completed remove it.



LCD

- Displays menus, parameters.

Edit key

- Used to set operating parameters.

(10) Transmitter Connection Cable:

- Connect when using the transmitter to wirelessly transfer settings of GPB-1 to CGY.



(1) RPM (Revolution sensor):

- Connect the revolution sensor.

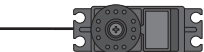

(2) AIL Output:

- Connect the aileron (roll) servo.

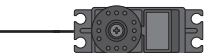

(3) ELE Output:

- Connect the elevator (pitch) servo.

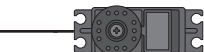

(4) PIT Output:

- Connect the pitch (collective pitch) servo.

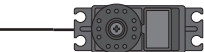

(5) THR Output:

- Connect the throttle servo.
- Connect the ESC w/BEC and set the operation mode to Gyro+THR mode.



(6) RUD Output:

- Connect the rudder (yaw) servo.

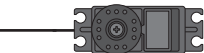

(7) ELE2 Output:

- Connect the second elevator servo.

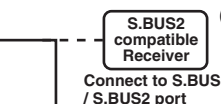

(8) S.B2 Output:

- Connect the S.BUS2 tool.
- CGY755 can be used with S.BUS/S.BUS2 compatible receiver.

* When connecting a S.BUS compliant receiver, connect only the receiver.

If you want to use another receiver with CGY760R, set the Internal receiver of the CGY760R to "INH".

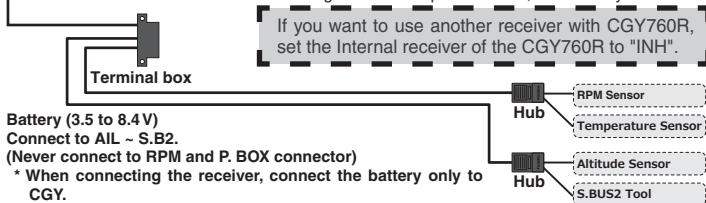

*This diagram shows the various connections between the CGY760R/CGY755 and receiver, servo, or sensors.

*S.BUS2 is a system that supports bidirectional communication from a telemetry sensor to a receiver by extending the conventional S.BUS. Telemetry sensor(s), etc., are connected to S.BUS2 connector and used. S.BUS compatible servo(s), etc., can not be used with S.BUS2 connector terminal.

S.BUS Channel Setting

The default CGY760R/CGY755 S.BUS channel assignments should work properly with most Futaba transmitters. If you experience any problems please refer to the S.BUS section of the manual to set / verify each channel number for each function.

1. The "SBUS BASIC" menu of CGY760R/CGY755 is displayed.
2. Use the [▲/+] or [▼/-] key to select "AIL CH #" and press the [Enter] key to enter setting mode. Check the transmitter's aileron channel and set it to match the channel with the [▲/+] or [▼/-] key. When you are done, press [Enter] key to exit setting mode.
3. Perform the same operation as above and set the function (such as aileron, pitch, collective, tail rotor gain, rotor head gain, RPM, gv on/off) channels to the transmitter.
4. If your transmitter does not offer enough channels to operate all of the CGY's functions, it is possible to operate the CGY760R/CGY755 without the Gov SW, Rotor Head Gain channels connected. When any of these functions are not used, it is necessary to set the channel number to "INH" within the CGY's S.BUS menu. Doing so disables the function and enables the user of the value set in the CGY760R/CGY755 menu accordingly.

When the Gov SW channel is not used, the governor on/off control is handled by the [Stick Switch] function.

Governor Installation

To install the governor, it will be necessary to modify the helicopter's cooling fan. Installation of the sensor and magnet are shown below. Balance the cooling fan as needed following magnet installation.

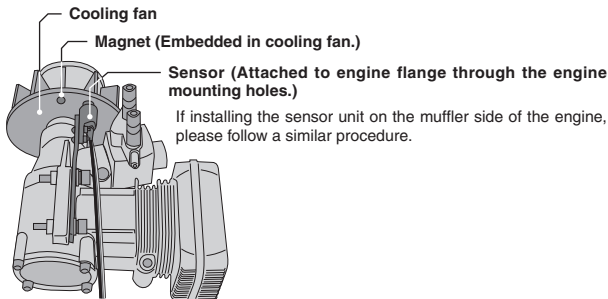

❑ *Magnet Operating Side Check*

Bring the magnet near the end of the sensor and check the operating side.

*This is the side at which the displayed value increases in the "Revolution sensor testing" menu within the "Governor Basic Setting" section earlier in this manual. Install the magnet with this side facing the sensor. Mark this side of the magnet with a felt tip pen.

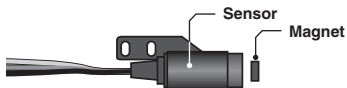

❑ *Cooling Fan Modification*

1. Drill a hole in the fan at the magnet mounting position. Make the hole about 4.1 mm in diameter and 1.5 to 1.7 mm deep.
2. Embed the magnet in this hole in the direction in which an output is obtained. Use epoxy adhesive that cures in 30 minutes or longer. Do not use epoxies that contain metal such as JB Weld.

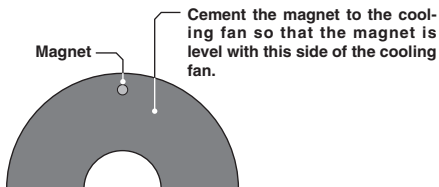

3. If the cooling fan is unbalanced and vibrates, etc., balance it by mounting the spare magnet to the opposite side of the cooling fan in the opposite polarity (so that it does not output a signal).

❑ *Sensor Mounting*

The sensor mounting method depends on the model and engine.

1. Temporary the sensor to the sensor mount.
2. Drill a hole in the fan cover at the part corresponding to the sensor so that the distance between the sensor and magnet can be made 1 to 2 mm.

- Tighten the sensor stay together with the engine mounting flange. (Temporary assembly)
- Select the mounting method so that the sensor does not touch the frame, or other parts of the model. Temporarily mount the sensor and select the magnet mounting position.
- Install the sensor to the sensor stay using the accessory screws and washers.
- Tighten the sensor stay together with the engine using the engine mount screw.

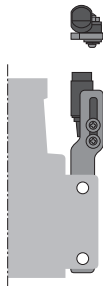

❑ *Sensor Adjustment*

- Adjust the sensor position to obtain a sensor output of at least 60% in the "Revolution sensor testing" menu within the "Governor Basic Setting".

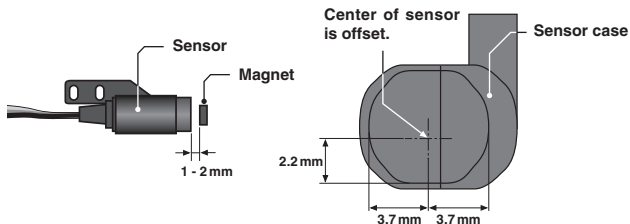

- The center of the sensor is different from the center of the sensor case so be careful when mounting the sensor.
If the display is less than 60% when the magnet is directly below the sensor, bring the sensor closer to the magnet so that the 60% or more is displayed. The magnet and sensor gap criteria is approximately 1 to 2 mm. If a sensor output is not obtained even when the sensor is brought close to the magnet, the magnet and sensor center positions may have changed.
- Complete assembly of the sensor by securely tightening the screws that were temporarily tightened.
- Recheck the sensor output.

❑ *Throttle Servo Linkage Precautions*

- To effectively use the governor, observe the following precautions when connecting the servo linkage.
- Make the servo operating range as wide as possible. Make the throw of the transmitter EPA (ATV) function and AFR function as close as possible to 100%.
- Fly with the governor turned OFF and adjust the needle so that the engine smoothly reacts to movement of the transmitter stick.
- If there is a point at which the reaction of the engine is considerably different due to a too rich or too lean mixture, the governor may not operate to its maximum potential.

❑ *Fuselage Vibration Countermeasures*

If the model frame is weak, or the engine mount is deformed or not installed properly, the vibrations applied by the engine will increase. Engine vibrations will lead to unstable speed and prevent the governor from providing maximum performance. Therefore, make sure that the engine is vibration free and that the carburetor provides linear throttle control because the governor can not correct engine problems.

❑ *Use Of A Tuned Silencer*

The use of a tuned pipe type silencer may cause the engine throttle response to be substantially different from that of a normal muffler. Adjust the needle (and pipe length) so that engine speed changes are proportional to the throttle opening. The governor will not perform satisfactorily with a muffler or a pipe that does not allow the carburetion to be linear.

FIRST MAP

Connect GPB-1 (Gyro Program Box) And CGY

The GPB-1 is used to display the gyro and governor settings, adjust the gyro and governor settings, and use to initialize updates, etc.

Connect the receiver battery (3.5 to 8.4 V) to one of the "AIL" to "S.B2" connectors other than "RPM" and "P.BOX".

(Do not connect to "RPM" and "P.BOX".)

Connect the battery

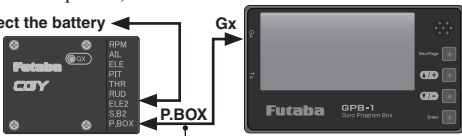

CGY Connection Cable

It is used to connect the CGY760R/CGY755 and the Gyro Program Box GPB-1.

⚠ CAUTION

❗ Be sure to connect and disconnect the CGY760R/CGY755 and GPB-1 connection cable with the power off.

Opening Screen

When GPB-1 starts up with power on, the opening screen is displayed first.

⚠ CAUTION

❗ Since the data of CGY or GPB-1 is rewritten, always check the operation key.

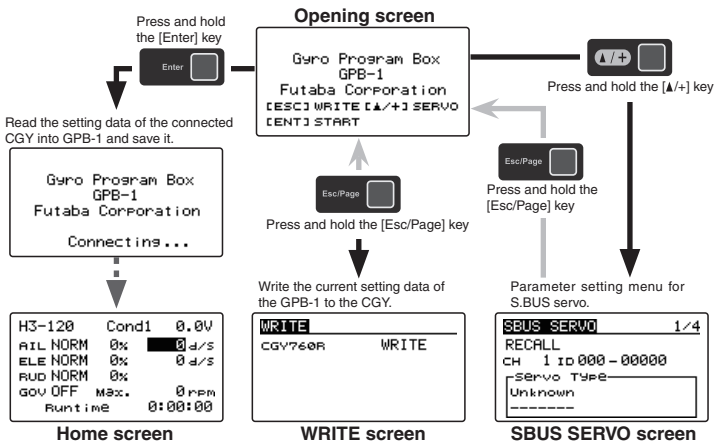

Each menu screen is displayed from the home screen.

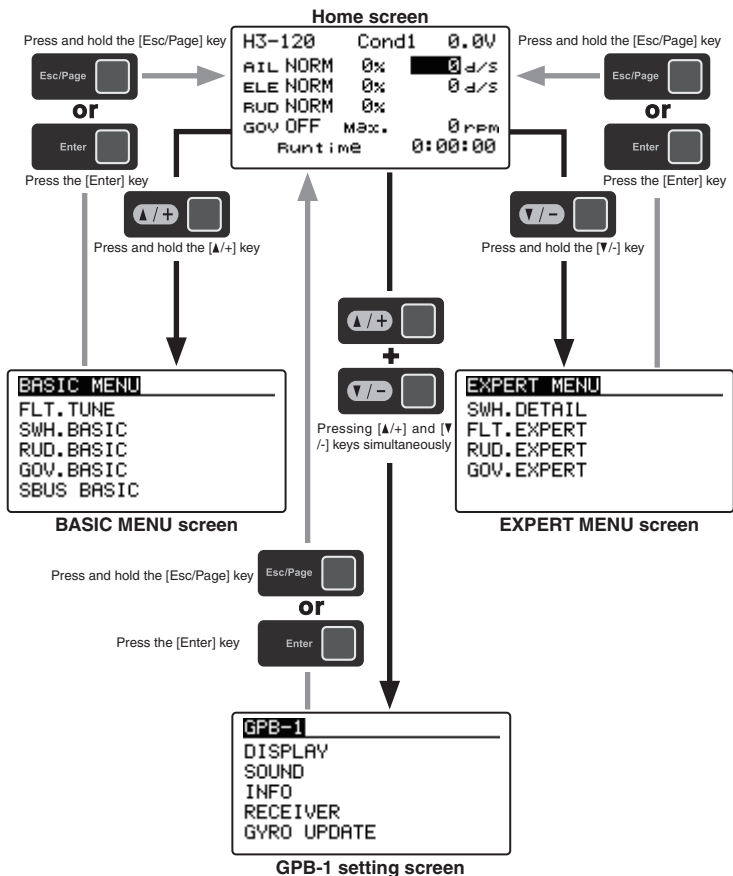

HOME SCREEN

Home Screen Display

On the home screen, basic information such as swash type, gyro operation mode, sensitivity and governor ON / OFF, engine operating time etc, are displayed.

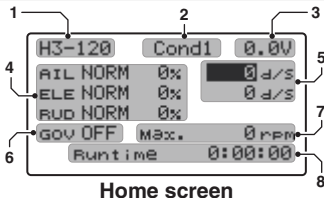

1. Swash plate type

Displays the swash plate type set in "SWH. BASIC" menu.

2. Condition number

With switch operation from the transmitter, several parameters can be switched by setting up to 5 types of data. If you set the condition switch to the channel having the AFR function of the transmitter and set the point for each flight condition with the AFR point curve, it can also be linked with the flight condition switch.

•When either the DG1 or DG 2 switch is selected, the following options are available.

Function Menu of your transmitter (DG1). Assigning DG1 to a switch or flight mode allows the use of two separate values for the condition selectable parameters.

For functions that can set conditions in this manual, mark **Cond** is written.

Cond1 (Condition 1)

- SWS.Rate
- PIT.Rate
- SWS.Ring
- FLT.Styl
- Cnt.AuthAI
- Cnt.AuthEL
- EXPO
- HeadHld A
- HeadHld E
- StpTune A
- StpTune E
- HeadResp
- BaseGain AI EL
- CYC.Rt
- GOV.Gain
- L.Lmt.H rpm
- L.Lmt.L rpm

Cond2 (Condition2)

- SWS.Rate
- PIT.Rate
- SWS.Ring
- FLT.Styl
- Cnt.AuthAI
- Cnt.AuthEL
- EXPO
- HeadHld A
- HeadHld E
- StpTune A
- StpTune E
- HeadResp
- BaseGain AI EL
- CYC.Rt
- GOV.Gain
- L.Lmt.H rpm
- L.Lmt.L rpm

*Indicates when the setup style is "3D".

Switch Channel Rate

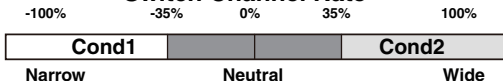

- If you set a condition switch channel, using the AFR function on that channel set a flat point curve for each flight condition. Then you can utilize all 5 flight conditions.

Switch Channel Rate

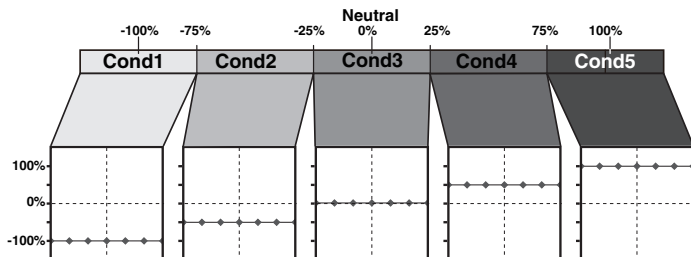

Set the point curve with AFR for each flight condition of the transmitter.

3. Battery voltage

Displays the voltage of the receiver battery connected to CGY.

4. Gyro operation mode / Gyro gain

Displays "AVCS" or "Normal" operation mode and gyro gain of aileron (roll), elevator (pitch) and rudder (yaw) axis.

5. Roll and Elevator rate maximum display

This screen displays the maximum roll rate and maximum elevator rate recorded during flight. Data is reset when the power is turned off. If you want to check the maximum rate, leave the power on after flight. Use the [▲/+] or [▼/-] key to move the cursor to each rate display and press and hold [Enter] key to reset the display.

6. Governor ON / OFF

Indicates the ON / OFF switch status of the governor function. When "ON" is displayed, the governor function is activated.

7. RPM display

The maximum RPM of the engine or rotor head RPM memorized by the governor during operation is displayed. Data is reset when the power is turned off. If you want to check multiple times during the flight, leave the power on after flight. Use the [▲/+] or [▼/-] key to move the cursor to the engine RPM display and press and hold [Enter] key to reset the display.

8. Engine running time

Displays the running time of the engine. Up to 9,999 hours are displayed.

Use the [▲/+] or [▼/-] key to move the cursor to the operation time display and press and hold [Enter] key to reset the display. The operation time is stored in memory even when the power is turned off until it is reset.

How to operate each menu screen

Use the [▲/+] or [▼/-] key to move the cursor to the setting item on the screen and press the [Enter] key to enter the setting mode. [▲/+] or [▼/-] key to change the setting contents. When you are done, press [Enter] key to exit setting mode.



How to set the function with condition (C1)

The function of each condition is set as follows.

SWH.BASIC		Condit	3/5
SWS.Dir	AIL		+
SWS.Dir	ELE		+
SWS.Dir	PIT		+
SWS.Rate		C1	50%
PIT.Rate		C1	50%

*The current condition number of CGY is displayed.

*The setting with "C#" display can be set for each condition.

1. Use the [▲/+] or [▼/-] key to move the cursor to "C#" and press the [Enter] key to enter the condition selection mode. Use the [▲/+] or [▼/-] key to select the condition number "C#" and press the [Enter] key to decide the condition number.
2. Next, adjust value of the condition selected by the [▲/+] or [▼/-] key, and press the [Enter] key to enter the setting mode. Use the [▲/+] or [▼/-] keys to change the setting value. When you are done, press the [Enter] key to exit the setting mode.

Data saving screen

After setting change the following screen will be displayed when saving data.

(Note that this is only displayed a short period of time.)

NOW SAVING DATA...

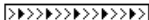

GPB-1 Screen

This is the menu option for setting the GPB-1 display, etc.

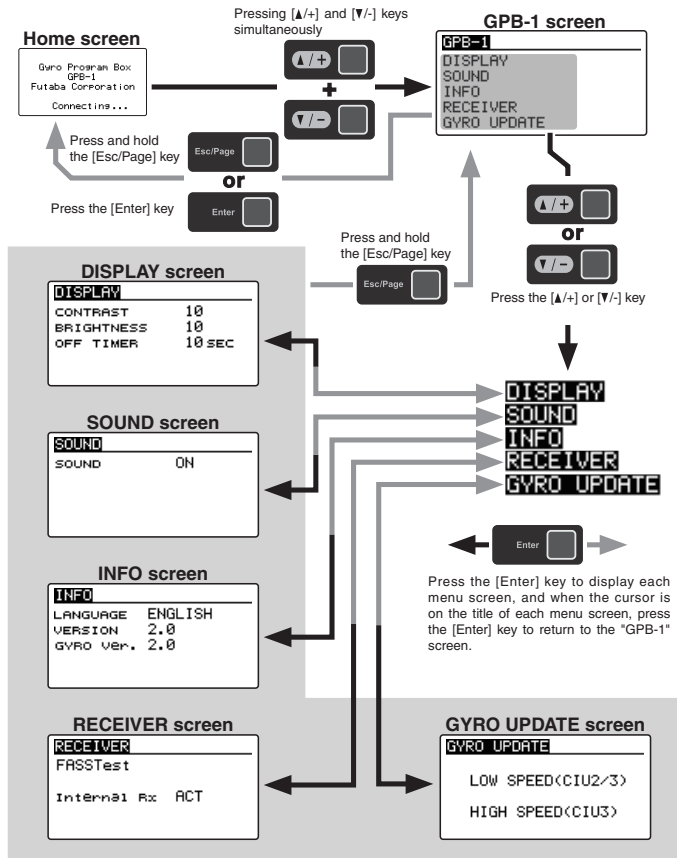

DISPLAY (display setting of GPB-1)

Set the contrast and brightness of the screen of the GPB-1 and the lighting time of the backlight.

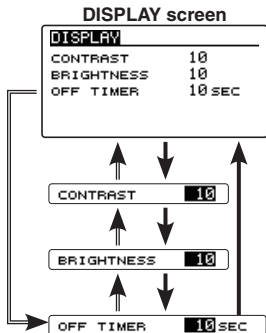

(1) CONTRAST

Move the cursor to "CONTRAST" with the [▲/+] or [▼/-] key and press the [Enter] key to enter the setting mode. Adjust the contrast with the [▲/+] and [▼/-] keys. When you finish adjusting, press [Enter] key to exit setting mode.

Setting ranges: 0 ~ 20 Initial value: 10

(2) BRIGHTNESS

Move the cursor to "BRIGHTNESS" with the [▲/+] or [▼/-] key and press the [Enter] key to enter the setting mode. Adjust the brightness with the [▲/+] and [▼/-] keys. When you finish adjusting, press [Enter] key to exit setting mode.

Setting ranges: OFF (Backlight off) / 0 ~ 20 Initial value: 10

(3) OFF TIMER

Adjust the time until the backlight turns off after the last key operation.

Move the cursor to "OFF TIMER" with the [▲/+] or [▼/-] key and press the [Enter] key to enter the setting mode. Use the [▲/+] and [▼/-] keys to adjust the lighting time of the backlight.

When you finish adjusting, press [Enter] key to exit setting mode.

Setting ranges: OFF (Always on) / 0 ~ 240 sec Initial value: 10 sec

SOUND (Key beep sound of GPB-1)

This menu is used to turn on, or off, the sounds when the keys of the GPB-1 are utilized. Refer to page 33 to display the "SOUND" screen from the GPB-1 menu screen.

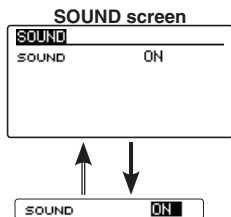

(1) SOUND

Set ON / OFF of key operation sound of GPB-1.
Move the cursor to "SOUND" with the [▲/+] or [▼/-] key and press the [Enter] key to enter the setting mode. Select the ON or OFF of key operation sound with the [▲/+] or [▼/-] key. When you finish setting, press [Enter] key to exit setting mode.

Setting: ON / OFF Initial setting: ON

INFO (Display language and version of GPB-1)

Displays the GPB-1 display language setting, program version and gyro version.

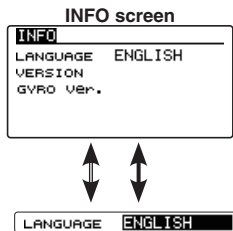

(1) LANGUAGE

Set the display language of GPB-1.
Move the cursor to "LANGUAGE" with the [▲/+] or [▼/-] key and press the [Enter] key to enter the setting mode. Select the display language with the [▲/+] or [▼/-] key. When you finish setting, press [Enter] key to exit setting mode.

-LANGUAGE
Setting: ENGLISH / JAPANESE / GERMAN
-VERSION: GPB-1 program version
-GYRO Ver.: CGY program version

On the "RECEIVER" screen, make sure that the CGY760R/CGY755 setting matches the protocol that is selected/utilized in the transmitter. "RECEIVER" screen from the GPB-1 menu screen.

Note:

To change the "Receiver System" type, first power off the transmitter and receiver, and re-power the CGY760R/CGY755 while the transmitter is still in the OFF position. The only way to change the receiver type is by power cycling the gyro first.

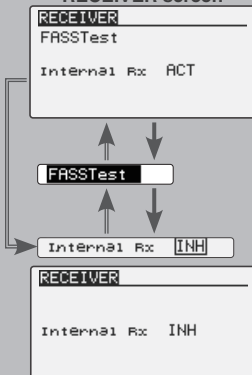
RECEIVER screen

With "INH" setting the receiver system will not display.

***Ignore this display for CGY755.**

(1) RECEIVER

Set the same system as the transmitter to be linked. Move the cursor to the system such as "FASSTest" with the [▲/+] or [▼/-] key and press the [Enter] key to enter the setting mode. Then select the system with the [▲/+] or [▼/-] key. Since "EXECUTE: Enter (1 sec)" is displayed. Pressing the [Enter] key for about 1 second changes the selected system and exits the setting mode. After changing the communication mode, link with the transmitter.

Setting: FASSTest- / T-FHSS

(2) Internal Rx

It is a setting to turn on / off the function of the internal receiver. In the same way as in "Receiver System", set ACT / INH of "Internal Rx" by pressing the [Enter] key for about 1 second. When "Internal Rx" setting is INH, (1) communication mode is not displayed.

Setting: ACT/ INH

⚠ CAUTION

❗ Please turn off the power when connecting the receiver.

If the power is on and connected, the CGY or the receiver may be damaged.

⚠ WARNING

❗ If you do not turn off the power after changing "Internal Rx" setting to INH, the internal receiver is in operation. After changing the setting, please power cycle. If the power is not cycled, the receiver will not keep bind and the helicopter will crash.

GYRO UPDATE (Update mode of CGY)

This menu is used to adjust the update mode of the CGY. The mode selected will be determined by the model of the CIU selected and personal preference. For example, when using the CIU-3, the user may select either the high speed or the slow speed modes. If using the CIU-2, only the slow speed mode is available.

* The following optional products are required for the update.

- CIU-2 or CIU-3
- Cable for CGY760R/CGY755/GY701/GY520 or DSC cable for update

(1) Download CGY760R/CGY755 update file

Download the CGY update file from our website or your local distributor's website.

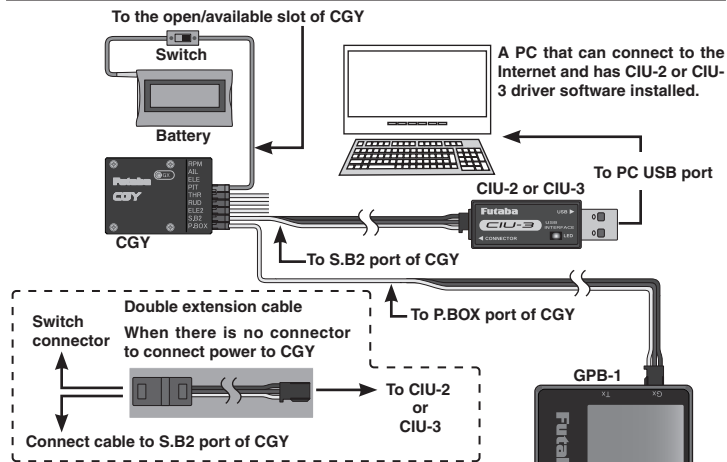

(2) Preparation for update -1

Connect the CGY, GPB-1, CIU-2 or CIU-3 to the PC with reference to the above connection diagram.

For CGY760R NOTE: Updating can NOT be performed when the transmitter and the CGY760R communicate or when "Internal Rx" setting is INH. Turn on the power of the CGY760R with "Internal Rx" being ACT and transmitter power OFF.

GYRO UPDATE screen

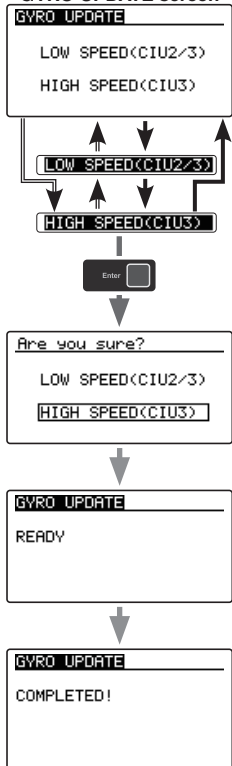

(3) Preparation for update -2

"GYRO UPDATE" screen from the GPB-1 menu screen.

⚠ CAUTION

⊘ Do not turn off the power or remove the battery while updating. CGY and GPB-1 may be damaged.

(4) Selection of CIU (Speed)

Use the [▲/+] or [▼/-] key to move the cursor to "LOW SPEED (CIU2/3)" or "HIGH SPEED CIU3" and press the [Enter] key. The "READY" indication will appear on-screen when the update is available.

(5) Perform update

Click on the update file downloaded to the PC to update the CGY.

(6) Update complete

When the update has been successfully concluded, "Completed" appears on the screen of GPB-1.

If the update is not performed normally, "FAILED !" will be displayed. In If the update has failed, please start the process once again from the beginning. Should it fail once more, it is likely that the update file has been corrupted when downloaded previously. Please download this file and restart the procedure.

GYRO UPDATE

FAILED !

BASIC MENU

As the name suggests, this menu allows changes to the basic settings of CGY. Make sure to set each "BASIC MENU".

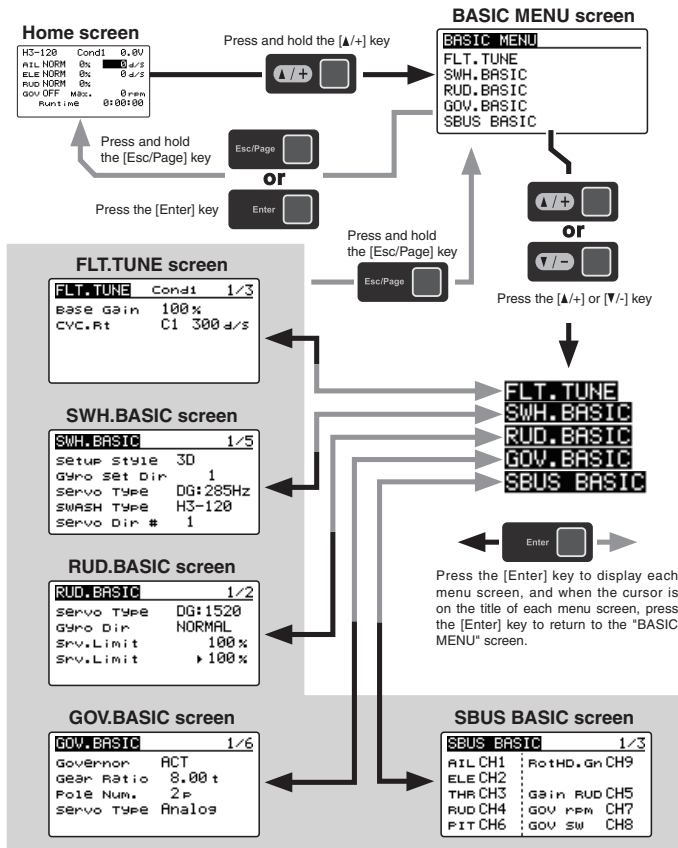

SBUS BASIC MENU (S.BUS BASIC SETTING)

The "SBUS BASIC" screen is accessed via the "BASIC MENU" screen. Set the CH for each function according to the transmitter to be used. Any unused functions should be set to INH (Inhibited). For example, if the Gain A/E and Gain RUD remote gain functions are not going to be used, then set them to [INH]. The CGY760R/CGY755 will then allow you to make gain adjustments within the respective menu.

From 3/3 *****
From the "RESET" of SBUS BASIC screen 3/3

SBUS BASIC screen 1/3

SBUS BASIC	1/3
AIL CH1	RotHD, Gn CH9
ELE CH2	
THR CH3	Gain RUD CH5
RUD CH4	GOV RPM CH7
PIT CH6	GOV SW CH8

Go to 2/3 from any cursor position



⚠ WARNING

❗ Always verify that the S.BUS function assignments match your transmitter's function (in the FUNCTION menu) assignments. If any changes are made within the transmitter function assignments, then it will also be necessary to make the changes within the S.BUS function assignments. To change the channel, CGY and GPB-1 must be connected.

Settings (all in common):
1 to 16 ch, DG1, DG2, INH

AIL CH1

(1) S. BUS connection: AIL (Aileron) channel

Move the cursor to "AIL CH #" by pressing the [▲/+] or [▼/-] key and press the [Enter] key to enter the setting mode. Use the [▲/+] or [▼/-] key to set the aileron channel of the transmitter. When you are done, press [Enter] key to finish. Follow this procedure to make the adjustments to all channels below.

ELE CH2

(2) S. BUS connection: ELE (Elevator) channel

Using the [▲/+] or [▼/-] key to set the correct channel number.

THR CH3

(3) S. BUS connection: THR (Throttle) channel

Using the [▲/+] or [▼/-] key to set the correct channel number.

RUD CH4

(4) S. BUS connection: RUD (Rudder) channel

Using the [▲/+] or [▼/-] key to set the correct channel number.

PIT CH6

(5) S. BUS connection: PIT (Pitch) channel

Using the [▲/+] or [▼/-] key to set the correct channel number.

Rot HD, Gn CH9
3D

(6) S. BUS connection: Rot HD Gn channel

Using the [▲/+] or [▼/-] key to set the correct channel number.

Gain AIL CH9
F3C

Gain ELE CH10

If the "Setup Style" setting of the "SWH BASIC" menu is "F3C", it is necessary to set the aileron (Roll) gain and the elevator (Pitch) gain on separate channels. (Gain AIL and Gain ELE on display)

Gain RUD CH5

(7) S. BUS connection: Gain RUD channel

Using the [▲/+] or [▼/-] key to set the correct channel number.

GOV rpm CH7

(8) S. BUS connection: GOV rpm channel

Using the [▲/+] or [▼/-] key to set the correct channel number.

GOV SW CH8

(9) S. BUS connection: GOV sw channel

Using the [▲/+] or [▼/-] key to set the correct channel number.

From 1/3

SBUS BASIC screen 2/3

```
SBUS BASIC 2/3
Cond -100 0 +100
Cond2 |---|---|
```

Cond DG1

Go to 3/3 from any cursor position

(10) S. BUS connection: Condition on change channel

Using the methodology described previously, determine the "Cond CH #" and use the [▲/+] or [▼/-] key to set the condition change channel of the transmitter. In this example, DG1 is the conditional change channel.

As with the flight condition function of the transmitter, it is possible to utilize pre-determined settings, each activated by a switch or switches on the transmitter. By setting the condition switch on the channel with the AFR function of the transmitter and setting the point for each flight condition with the AFR point curve, you can switch the condition of CGY760R/CGY755 in conjunction with the flight condition switch of the transmitter.

From 2/3
↑ ↓
▶ SBUS BASIC screen 3/3

SBUS BASIC	3/3
Via Trainer #1	INH
#2	INH
ELE2 Port	INH
RESET	RESET

↑ ↓ ▶ Go to 1/3 from any cursor position

Via Trainer #1	INH
Via Trainer #1	INH
#2	INH



ELE2 Port	INH
-----------	-----



⚠ CAUTION

- ❗ Be sure to check the operation for all conditions 1 to 5 before flying.
- ❗ The setting of "Via transmitter CH" is possible only when the transmitter and the CGY are powered off and the CGY is turned on.
- ❗ Be sure to connect and disconnect the CGY and GPB-1 connection cable with the power off.

(11) Via trainer channel

The transmitter's trainer channel uses two consecutive channels. For example, if CH11 is set to "# 1", CH12 is automatically set to "# 2". Therefore, when using this function, two consecutive free channels are required for the transmitter. It is not possible to use a channel assign that is used for another function. Move the cursor to "Via Trainer #" and press the [Enter] key to enter the setting mode. When "EXECUTE: Enter (1 sec)" is displayed. Use the [▲ /+] or [▼ /-] key to set the channels. Press the [Enter] key for about 1 second to set the channels for the programming via trainer from the transmitter.

(12) S. BUS connection: ELE2 (Elevator) channel

Select "ELE 2 CH *" in the same way as other S. BUS connection channels and use the [▲ /+] or [▼ /-] key to set the elevator 2 channels of the transmitter.

The "SWH BASIC" settings can be set only for H1 and H3-XX (When set to H4-XX, it is automatically set to ELE 's CH setting.) If you change the setting between H1 and H3, the CH will remain as it is.

ELE2 Port CH1
DG:285Hz

(13) ELE2 channel Servo Type

(If you want to use the ELE2 port for purposes other than swash.)

This selects the ELE2 servo types. There are three types of the servo driving frequency selection, AN:70 Hz, DG:285 Hz, and 760 μ S. All Futaba digital servos can be operated with fastest DG:285 Hz mode but some of other brands of servos do not support DG:285 Hz mode. In this case, select the proper servo driving frequency per the manufacturer's specifications. Move the cursor to "Servo Type" by pressing the [▲/+] or [▼/-] key and press the [Enter] key to enter the setting mode. Then select the servo type with the [▲/+] or [▼/-] key. When "EXECUTE: Enter (1 sec)" is displayed, press the [Enter] key for about 1 second. This changes the selected type and exits the setting mode.

If you select H4-00 or H4-45 with 4 servo swashes, cannot set this ELE2 port servo type. In that case, select all swash servo types in SWH basic servo type.

Setting: AN:70 Hz/DG:760 μ S/DG:285 Hz Initial setting: DG:285 Hz

⚠ WARNING

❗ The servo type parameter within the CGY must match the type of servo you are using. Incorrect setting may damage the CGY or the servo. Incorrect setting may also result in a loss of control during flight.

RESET RESET

Go to the menu title of
SBUS BASIC screen 1/3

EXECUTE: "Enter" (1sec)
Via Trainer #1 INH
 #2 INH
RESET RESET

(14) RESET: S.BUS data reset

This resets the S.BUS channel assignments back to the defaults. Move the cursor to "RESET" by pressing the [▲/+] or [▼/-] key, and press the [Enter] key to enter the reset mode. When "EXECUTE: Enter (1 sec)" is displayed, press and hold the [Enter] key for about 1 second to initialize S.BUS channel setting. If you do not wish to reset to the default settings, press [Enter] key or [Esc/Page] key to exit reset mode.

About Transfer Function Of Gyro Setting Data

With this function, by connecting the transmitter and the GPB-1 with the transmitter connection cable, it is possible to wirelessly change the setting of the CGY mounted on the model via the transmitter. For the list of functions that can be changed, refer to page 105. Before connecting the GPB-1 to the transmitter, please connect to the CGY first and save the original data to the GPB-1 accordingly.

Setting on transmitter side

1. Follow the transmitter's instruction manual, to set these items to the correct configuration. Use the TX's Function menu to set two consecutive free AUX channels to match the channel assignments set in the gyro SBUS menu. However, do not set the "Control" and "Trim" functions.
2. Set the two free channels to the following settings.
Sub Trim: 0 / Fail safe: hold / Battery fail safe: OFF / Set the end point: 100
The limit point: 155 (maximum) / Servo speed: 0 / Servo Reverse: Normal
3. Set the trainer function as follows according to the transmitter's instruction manual.
Always ON
Teacher/Student: ----- Teacher
Channel mode: ----- 16 CH
Mode for individual channels being used for gyro programming: ----- Normal
Rate: ----- 100

Point : In 12ch FASSTest mode only the first 12 channels can be used for wireless trainer. In 18ch FASSTest it is possible to use 18chs.

After connecting the GPB-1 to the transmitter via trainer port, power on the transmitter. Upon turning the transmitter "On" the GPB-1 will show the opening screen and the ID screen will be displayed. The ID number should be the same as the ID sticker on the CGY. If the ID numbers match, press and hold the [Esc/Page] key to display the trainer via function setting screen. **Note:** if the ID is different on the ID confirmation screen, connect CGY and GPB-1 to update the current set data of the CGY to GPB-1.

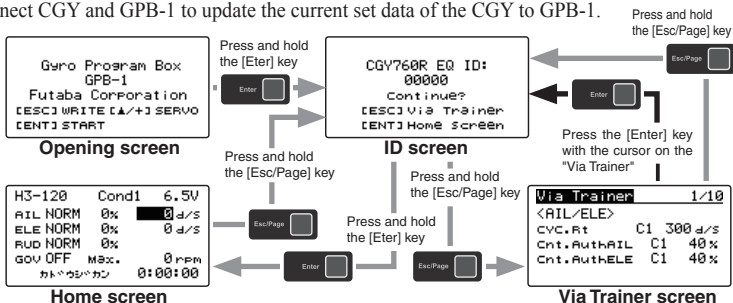

SWH. BASIC MENU (SWASH BASIC SETTING)

This menu is utilized to perform the basic setup of swash motion. "SWH. BASIC" screen from the "BASIC MENU" screen.

The CGY760R/CGY755 is compatible with the following six types swash plate.

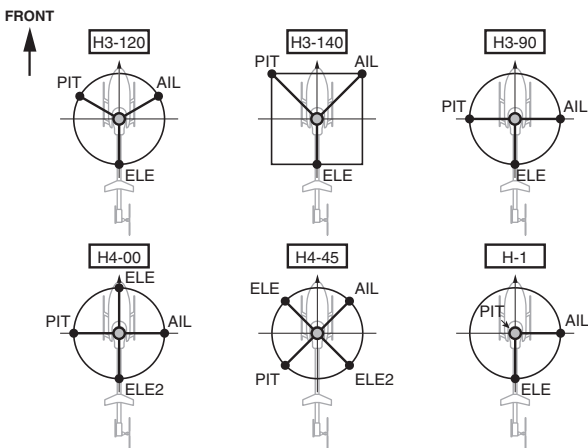

AIL ----- Aileron servo
ELE ----- Elevator servo
PIT ----- Collective pitch servo
ELE2 ----- Second elevator servo

Your transmitter should be reset to the default settings and the swash plate type selected with the transmitter should be set to "H-1" or single servo mode. All CCPM mixing is set up and handled in the CGY, and the transmitter functions should not be used. Before starting model set-up, be sure that all dual rates, pitch curve, and endpoint values are set to 100/100.



WARNING

 Do not connect the servo to the gyros until you select the servo type in the "SWH. BASIC" menu.

*If the servo type is incorrect, it is possible to damage the servos or CGY.

From 5/5... From the "Pit.Low" of SWH. BASIC screen 5/5

SWH. BASIC screen 1/5

```
SWH. BASIC 1/5
Setup style 3D
Gyro Set Dir 1
Servo Type DG:285Hz
SWASH Type H3-120
Servo Dir # 1
```



Go to 2/5 from any cursor position

```
Setup style 3D
```

(1) Setup style

3D mode contains a proven set of parameters which are good for not only 3D but also F3C flying. F3C Mode and L.SCALE (Large scale model) Mode are for unique or special tuning types only.

*When the style is changed, setting of AIL/ELE/RUD is re-initialized and defaults are changed.

Move the cursor to "Setup style" by pressing the [▲/+] or [▼/-] key and press the [Enter] key to enter the setting mode. Use the [▲/+] or [▼/-] key to set the style. When "EXECUTE: Enter (1 sec)" is displayed. Press the [Enter] key for about 1 second to changes the selected style. The program will also exit the setting mode accordingly.

L.SCALE: Initial parameter mode corresponding to a large machine with a total length of 2.5m or more.

```
Gyro Set Dir 1
```

(2) Gyro Set Dir: Mounting direction

Set the roll axis, pitch axis, yaw axis according to the mounting direction of CGY. Set mounting direction with reference to page 18-19. Move the cursor to "Gyro Set Dir" by pressing the [▲/+] or [▼/-] key and press the [Enter] key to enter the mounting direction. Then select the mounting direction # with the [▲/+] or [▼/-] key. When you finish setting, press [Enter] key to exit setting mode. When the LED on the Gx side finishes blinking, please turn the power off and on again to confirm that it is working properly.

Setting: 1 ~6 Initial setting: 1

WARNING

If you do not turn the power back on after changing "Gyro Set Dir", the gyro will not operate properly, there is a risk of crashing.

SERVO TYPE

DG:285HZ

(3) Servo Type

This selects the swash servo types. There are four types or modes of the servo driving frequency selection, AN:70 Hz, DG:95 Hz, DG:140 Hz, DG285 Hz, and 760 μ S. All Futaba digital servos can be operated with fastest DG:285 Hz mode but some of other brands of servos do not support DG:285 Hz mode. In this case, select the proper servo driving frequency per the manufacturer's specifications. Move the cursor to "Servo Type" by pressing the [\blacktriangle /+] or [\blacktriangledown /-] key and press the [Enter] key to enter the setting mode. Then select the servo type with the [\blacktriangle /+] or [\blacktriangledown /-] key. When "EXECUTE: Enter (1 sec)" is displayed, press the [Enter] key for about 1 second. This changes the selected type and exits the setting mode.

Setting: AN:70 Hz /DG:95 Hz /DG:140 Hz /DG:760 μ S /DG:285 Hz

Initial setting: DG:285 Hz

WARNING

 The servo type parameter within the CGY must match the type of servo you are using. Incorrect setting may damage the CGY or the servo. Incorrect setting may also result in a loss of control during flight.

SWASH TYPE

H3-120

(4) SWASH Type: Swash change to plate type

Select the swash plate type. Move the cursor to "SWASH Type" by pressing the [\blacktriangle /+] or [\blacktriangledown /-] key and press the [Enter] key to enter the setting mode. Then select the swash plate type with the [\blacktriangle /+] or [\blacktriangledown /-] key. When "EXECUTE: Enter (1 sec)" is displayed, press the [Enter] key for about 1 second. This changes the selected type and exits the setting mode. When you change the setting, other data is initialized.

Setting: H-1 /H3-120/H3-140/H3-90/H4-00/H4-45

Initial setting: H3-120

WARNING

 All of the swash plate parameters are reset when the swash plate type is changed. Doing so eliminates any possible errors or malfunctions within the system. After changing the swash plate type, Please proceed through the entire setup process once again before attempting to fly the model.

Servo Dir # 1

(5) Servo Dir #: Servo direction

Using different servo combinations will create the proper swash plate servo movement in electronic CCPM models (eCCPM). In the H3-xx swash mode, three of the swash servos directions are changed by pressing the [▲/+] or [▼/-] key. Choose the combination number which produces level swash plate travel with a collective pitch input from the transmitter. There are 8 combination choices for the H3-xx swash mode. On H4-xx swash mode, there are 16 combination choices. After selecting the combination number, aileron, elevator, pitch, and 2nd elevator servo parameters are automatically set.

Note: Occasionally the aileron or elevator function directions are reversed even though collective pitch direction is correct. In this case, use the "SWS.Dir" parameter on the following screen (3/5) to fix this later.

From 1/5

H1 or H3 SWH. BASIC screen 2/5 H4

SWH. BASIC	2/5
AIL.Ntr	+0
ELE.Ntr	+0
PIT.Ntr	+0

SWH. BASIC	2/5
AIL.Ntr	+0
ELE.Ntr	+0
PIT.Ntr	+0
ELE2.Ntr	+0

Go to 3/5 from any cursor position

AIL.Ntr +0

(6) AIL, ELE, PIT. Ntr: Servo neutral adjustment

Use the [▲/+] or [▼/-] key to adjust the neutral position of the swash servo (aileron, elevator, pitch, second elevator). The second elevator (ELE2) is displayed only when the swash type is H4-xx.

Setting ranges: +240 ~ -240 Initial value: 0

ELE.Ntr +0

PIT.Ntr +0

ELE2.Ntr +0

ELE2 is displayed only when the swash type is H4-xx

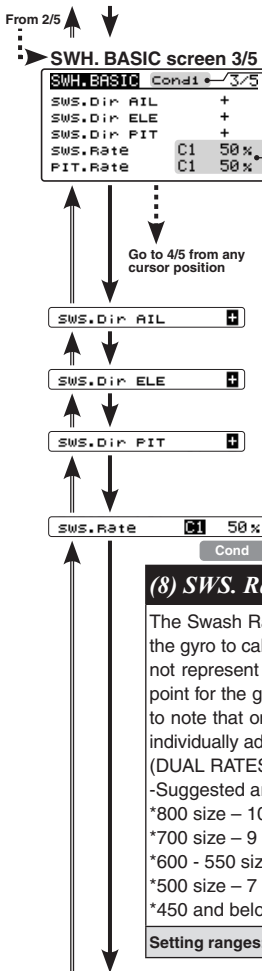

*The current condition number of CGY is displayed.

*The setting with "C#" display can be set for each condition.

1. Use the [▲/+] or [▼/-] key to move the cursor to "C#" and press the [Enter] key to enter the condition selection mode. Use the [▲/+] or [▼/-] key to select the condition number "C#" and press the [Enter] key to decide the condition number.
2. Next, adjust value of the condition selected by the [▲/+] or [▼/-] key, and press the [Enter] key to enter the setting mode. Use the [▲/+] and [▼/-] keys to change the setting value. When you are done, press the [Enter] key to exit the setting mode.



(7) SWS. Dir: Swash direction setting

This selects the aileron, elevator and collective pitch direction. Reverse the direction when the stick movement and swash movement are opposite. Each time you press the [▲/+] or [▼/-] key, the polarity switches.

(8) SWS. Rate: Rate adjustment

The Swash Rate settings are used to set a known base cyclic throw for the gyro to calculate the compensations and gain scale. This value does not represent the total cyclic throw, but rather shows the gyro a known point for the gyro to understand the helicopters geometry. It is important to note that one setting applies to both roll and pitch axes; they are not individually adjusted. Use the [▲/+] or [▼/-] key to make an adjustment. (DUAL RATES MUST BE 100)

-Suggested amount of base cyclic pitch

*800 size – 10 degrees

*700 size – 9 degrees

*600 - 550 size – 8 degrees

*500 size – 7 degrees

*450 and below- 6 degrees

Setting ranges: 0 ~ 100% Initial value: 50%

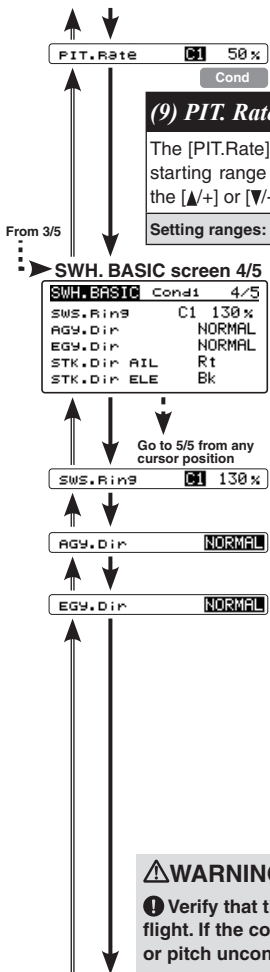

(9) PIT. Rate: Rate adjustment

The [PIT.Rate] is the amount of collective pitch travel allowed. A good starting range for Sport, 3D and F3C is +/-10 to +/-12 degrees. Use the [▲/+] or [▼/-] key to make an adjustment.

Setting ranges: 0 ~ 100 Initial value: 50%

(10) SWS. Ring

This parameter is used to set the total maximum of cyclic throw as well as limit the swash travel to prevent binding of the swash plate servos when the control stick is moved toward a corner (for example, full right and full aft cyclic). Press the [▲/+] or [▼/-] key to adjust the value.

Setting ranges: 50 ~ 100% Initial value: 130%

(11) AGy. Dir: Aileron (roll) Gyro direction EGy. Dir: Elevator (pitch) Gyro direction

This parameter controls which direction the CGY (roll / pitch axis) will compensate when the helicopter rolls (pitches). Pick the helicopter up and roll the helicopter to the right. The CGY should compensate by adding left cyclic to the swash plate. (Pick the helicopter up and rotate the nose of the helicopter downward. The CGY should compensate by adding aft cyclic to the swash plate.)

If the CGY compensates in the wrong direction, then it will be necessary to reverse the compensation direction setting by pressing the [▲/+] or [▼/-] key once.

⚠ WARNING

❗ Verify that the CGY compensates in the correct direction before flight. If the compensation direction is incorrect the model will roll or pitch uncontrollably even before it leaves the ground.

↑ ↓
STK.Dir AIL [Rt]

(12) STK. Dir AIL: Aileron operation

Move the cursor to "STK. Dir AIL" by pressing the [▲/+] or [▼/-] key and press the [Enter] key to enter the setting mode. When "EXECUTE: Enter (1 sec)" is displayed, move the aileron stick to the full right direction. Pressing the [Enter] key for about 1 second will memorize the aileron's direction of motion.

↑ ↓
STK.Dir ELE [Blk]

(13) STK. Dir ELE: Elevator operation

Move the cursor to "STK. Dir ELE" by pressing the [▲/+] or [▼/-] key and press the [Enter] key to enter the setting mode. When "EXECUTE: Enter (1 sec)" is displayed. Next, move the elevator stick to the full up direction. Pressing the [Enter] key for about 1 second will memorize the elevator's direction of motion.

Be sure to set this aileron motion direction and elevator motion direction so that F/F mixing (Ele Comp and Rud. F/F menu) works effectively. Also, please perform this operation after setting the direction of operation.

From 4/5

SWH. BASIC screen 5/5

SWH.BASIC	5/5
Pit.High	1100
Pit.Zero	1520
Pit.Low	1940

Go to 1/5 from any cursor position

Be sure to perform "Pit.High", "Pit Zero" and "Pit Low" setting.

Pit.High 1100

(14) Pit. High: Pitch high memorizing

This parameter saves the full positive collective pitch point into the CGY. Move the cursor to "Pit. High" by pressing the [▲/+] or [▼/-] key. Press the [Enter] key to enter the setting mode. "EXECUTE: Enter (1 sec)" is displayed. Move the collective pitch stick to full positive pitch and pressing the [Enter] key for about 1 second. The full positive pitch signal will be saved to the CGY.

Pit.Zero 1520

(15) Pit. Zero: Pitch zero memorizing

This parameter saves the zero collective pitch point into the CGY. Move the cursor to "Pit. Zero" by pressing the [▲/+] or [▼/-] key. Press the [Enter] key to enter the setting mode. "EXECUTE: Enter (1 sec)" is displayed. Move the collective pitch stick to 0 degree pitch and pressing the [Enter] key for about 1 second. The zero pitch signal will be saved to the CGY.

Pit.Low 1940

(16) Pit. Low: Pitch low memorizing

This parameter saves the full negative collective pitch point into the CGY. Move the cursor to "Pit. Low" by pressing the [▲/+] or [▼/-] key. Press the [Enter] key to enter the setting mode. "EXECUTE: Enter (1 sec)" is displayed. Move the collective pitch stick to full negative pitch and pressing the [Enter] key for about 1 second. The full negative pitch signal will be saved to the CGY.

Go to the menu title of
SWH BASIC screen 1/5

FLT. TUNE MENU (FLIGHT TUNING SETTING)

Flight tune sets control of helicopter roll (aileron) and pitch (elevator) axis. "FLT. TUNE" screen from the "BASIC MENU" screen.

From 3/3
From the "HP.Auth." of
FLT. Tune screen 3/3

FLT. TUNE screen 1/3

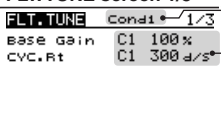

*The current condition number of CGY is displayed.

- *The setting with "C#" display can be set for each condition.
1. Use the [▲/+] or [▼/-] key to move the cursor to "C#" and press the [Enter] key to enter the condition selection mode. Use the [▲/+] or [▼/-] key to select the condition number "C#" and press the [Enter] key to decide the condition number.
 2. Next, adjust value of the condition selected by the [▲/+] or [▼/-] key, and press the [Enter] key to enter the setting mode. Use the [▲/+] and [▼/-] keys to change the setting value. When you are done, press the [Enter] key to exit the setting mode.

Go to 2/3 from any
cursor position

Base Gain C1 100% Cond



(1) Base. Gain: Gyro base gain setting

This sets the Cyclic Gyro Base Gain. If the Rotor Head Gain (Rot HD Gn) Channels are set to "INH" within the CGY "SBUS.BASIC" menu, then the remote transmitter gain adjustment is not available. Thus the actual working gain for the cyclic gyros is set by using the [▲/+] or [▼/-] key within this parameter.

Set to 100, a transmitter Gain value of 100% will display 100% on the GPB-1. If a pilot is in need of more gain, base gain can be increased to allow the gain on the CGY to be higher than 100%.

Note: If using a 6 CH or less "Base Gain" is equivalent to the rotor head gain and can be adjusted manually on the gyro instead of via the transmitter.

Setting ranges: 0 ~ 150% Initial value: 100%

CVC.Rt C1 300 d/s

Cond

(2) CYC. Rt: Cyclic rate setting

Cyclic rate sets the maximum Cyclic rate sets the maximum roll and flip rate (d/s) as limited by the model's ability to reach that set rate. Flip and roll rates are set together with this single parameter. The cyclic rate is set by using the [▲/+] or [▼/-] key.

Setting ranges: 10 ~ 500 d/s Initial value: 300 d/s

From 1/3

FLT.TUNE screen 2/3

FLT.TUNE	Cond1	2/3
Cnt.AuthAIL	C1	40%
Cnt.AuthELE	C1	40%
EXPO.	C1	-20%
FLT.Styl	C1	+50n

Go to 3/3 from any cursor position

Cnt.AuthAIL C1 40%

Cond

(3) Cnt. AuthAIL: Control Authority Aileron

Aileron Control Authority changes the rate at which the gyro will try to achieve the set "CYC. Rt". A higher value will create a quicker accelerated reaction to a stick input to reach and stabilize to the "CYC. Rt" value; a lower value will reach the desired "CYC. Rt" slower and accelerate slower to the desired angular rate.

Note: Setting this value too high could lead to a jerky feeling when making rapid stick corrections, a value too low will give you the impression the model is not following the pilot's stick inputs. Values of between 20-60 are the suggested range for most helicopters.

Setting ranges: 0 ~ 100%
Initial value: Cnt. AuthAIL = 40%

Cnt.AuthELE C1 40%

Cond

(4) Cnt. AuthELE: Control Authority Elevator

Elevator Control Authority changes the rate at which the gyro will try to achieve the set "CYC. Rt". A higher value will create a quicker accelerated reaction to a stick input to reach and stabilize at the "CYC. Rt" value; a lower value will reach the desired "CYC. Rt" slower and accelerate slower to the desired angular rate.

Note: Setting this value too high could lead to a jerky feeling when making rapid stick corrections, a value too low will give you the impression the model is not following the pilot's stick inputs. Values of between 20-60 are the suggested range for most helicopters.

Setting ranges: 0 ~ 100%
Initial value: Cnt. AuthELE = 40%

EXPO. C1 -20% Cond

(5) EXPO.: Exponential

Tune the exponential as desired to change the feel of the cyclic controls around center stick. Negative values soften control feel; Positive values increase sensitivity. The exponential rate is set by using the [▲ /+] or [▼/-] key.

Note: that any exponential present in the TRANSMITTER adds to the value set in the CGY.

Setting ranges: -100 ~ 0 ~ +100% Initial value: -20%

FLT. Styl C1 +50 n Cond

(6) FLT. Styl: Flight style

Increasing this value will create a more robotic reaction to the stick, leaving the pilot with the impression that the model is locked into in a position after an input. It will also tend to have a more calculated feeling when making inputs.

-Lowering the value will make the model feel more fluid and easy to rotate with the stick input. The model will feel a little more lively during faster cyclic movements and direction changes. Set by using the [▲ /+] or [▼/-] key.

Setting ranges: 0 ~ +100 n Initial value: +50 n

From 2/3

▶ FLT. TUNE screen 3/3

FLT. TUNE	Cond1	3/3
ELE. COMP	C1	0%
HP. Auth.		0%

▶ Go to 1/3 from any cursor position

Note: To effectively operate the next "ELE Comp" (elevator correction), make sure to set "Pit High", "Pit Zero", "Pit Low" on the "SWITCH BASIC" menu.



(7) ELE. Comp: Elevator pre compensation

A helicopter that has a head that rotates clockwise, will exhibit a tendency whereby the nose will be pulled towards the disk with positive blade pitch. Conversely, the helicopter will push the nose away from the rotor disk during negative pitch inputs. In an instance of a slower servo set-up or larger (heavier) rotor blades, a small amount of elevator pre compensation may be needed to keep the nose of the helicopter flat at all times during collective pitch changes. In most cases with helicopter high-speed servos and standard 3D rotor blades, this function is not needed. If you do notice a slight tendency for the nose to try to rise or fall with collective input, increasing "ELE Comp" will reduce this behavior.

Setting ranges: 0 ~ 100% Initial value: 0%



(8) HP. Auth.: High pitch authority

When a rotor blades angle of attack is increased, the rotor blade becomes less reactive, in turn the helicopter might not feel as reactive at high pitch angles. If you want to increase the reaction of the cyclic during loaded and high pitch maneuvers, "HP. Auth" will increase control authority and can be used to make the helicopter feel more linear under loading. Some helicopters with direct link CCPM may use this to increase stability at high collective pitch flying as well. If a helicopter feels good for normal flying, but not the same during loaded situations, "HP. Auth" can be used to make it feel more linear. If "HP. Auth" is set very high, the helicopter will feel more aggressive at high pitch than around neutral.

Setting ranges: 0 ~ 100% Initial value: HP. Auth = 0%

Go to the menu title of FLT.TUNE screen 1/3



RUD. BASIC MENU (RUDDER GYRO BASIC SETTING)

In the "RUD. BASIC" menu, you make the basic setting of the rudder gyro.

"RUD. BASIC" screen from the "BASIC MENU" screen.

⚠ WARNING

⊘ Do not connect the tail rotor servo to the gyro until the servo type has been selected. Operating the servo using the incorrect setting may damage the CGY or the servo.

⊘ Do not operate with the linkage connected until the "Srv. Limit" function correctly sets the servo limit point. If the servo operates beyond the linkage operating range, there is a danger of either the servo or helicopter being damaged.

Setting on transmitter side

The following transmitter setting example shows the case of using Futaba GY gyro mixing. Please read in accordance with your system.

1. Enable rudder gyro mixing.
2. In the gyro mode select "GY".
3. Temporarily set the gyro sensitivity of normal condition and hold condition to AVCS 75%. Also, temporarily set the gyro sensitivity of all idle up conditions to AVCS 50%.
4. Set the channel angle setting function (ATV / AFR / EPA) of the rudder channel and sensitivity setting channel to 100%.
5. Temporarily set the D/R function of the rudder channel to 75% both left and right.
6. We recommend that you temporarily set the EXP function of the rudder channel to about -30% (mild side 30%) need to clarify what is meant by mild side.

* Please note that these are only the temporary settings. Final values will be determined during flight.

From 2/2
 From the "Work Mode," of
 RUD. BASIC screen 2/2
 3D RUD. BASIC screen 1/2

```

RUD. BASIC 1/2
Servo Type  DG:1520
Gyro Dir    NORMAL
Srv.Limit   100%
Srv.Limit   ▶100%
  
```



Go to 2/2 from any
 cursor position

⚠ WARNING

❗ The servo type parameter within the CGY must match the type of servo you are using. Incorrect settings may damage the CGY or the servo. An incorrect setting may also result in a loss of control during flight.

Servo Type DG:1520

(1) Servo Type

Select the appropriate setting for the tail rotor servo. Move the cursor to "Servo Type" by pressing the [▲/+] or [▼/-] key and press the [Enter] key to enter the setting mode. Then select the servo types: DG1520, DG760 or Analog with the [▲/+] or [▼/-] key. When "EXECUTE: Enter (1 sec)" is displayed, press the [Enter] key for about 1 second to changes the selected type and exits the setting mode.

Setting: Analog /DG:1520 /DG760
 Initial setting: DG:1520
 DG 1520: BLS254, BLS257, S9254, S9257
 DG 760: BLS276SV, BLS251SB, BLS251, S9256, S9251

Gyro Dir NORMAL

(2) Gyro. Dir: Gyro direction

This parameter controls which direction the CGY (yaw axis) will compensate when the helicopter rotates. Hold the tail rotor linkage over the linkage ball on the servo, pick the helicopter up by the main shaft and rotate the mechanics counter-clockwise. The CGY should compensate by adding clockwise rotation pitch to the tail rotor blades. If the CGY compensates by adding counter-clockwise rotation pitch to the tail rotor blades, then it will be necessary to reverse the Compensation Direction setting by pressing the [▲/+] or [▼/-] key.

Setting value: Normal /Reverse Initial value: Normal

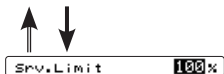

(3) Srv. Limit: Limit setting

When the CGY is in the "Srv.Limit" parameter mode, the gyro will no longer operate and the tail servo will always center when the tail rotor stick is released. Always exit the setup functions before attempting to fly the model. Before each flight, always ensure that the gyros are operating and compensating in the correct direction. The Servo Limit parameter within the CGY is used to set the mechanical limits for the tail rotor servo. To obtain the best performance it is recommended to set the limit in the CGY to 100% for both directions and then adjust the servo arm length to set the mechanical endpoints. After that has been completed, use the servo limit parameter to make small adjustments that could not be made mechanically. Values between 90% and 110% are considered optimal. Hold the cursor to "Srv.Limit" by pressing the [▲/+] or [▼/-] key. Gradually move the rudder stick to the left or right by the maximum amount the "►" cursor moves. Enter the setting mode by pressing the [Enter] key, increase or decrease the maximum throw using the [▲/+] or [▼/-] key, and then press the [Enter] key to exit the setting mode. Set the same way on the other side. Ensure that the pitch slider does not bind at the maximum movement inputs.

⚠ WARNING

❗ When using the CGY for the first time, or when making mechanical changes involving throw, you must check and set the servo limits again to prevent binding.

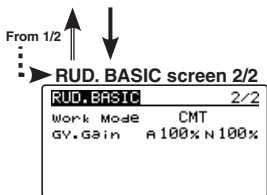

(4) Work Mode: Gyro working mode

The available choices are CMT, Normal or AVCS. The CMT mode will allow you to select either AVCS or Normal mode via the transmitter. In Normal mode the gyro will always operate in Normal Rate Mode, and when AVCS is selected, it will always operate in AVCS Mode. Use the [▲ /+] or [▼ /-] key to select the desired working mode.

Setting: CMT/Normal/AVCS Initial setting: CMT

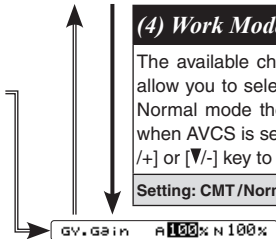

(5) GY. Gain: Gyro base gain setting

This parameter sets the base gain of the gyro. This can be used to adjust the gain % if your actual transmitter gain does not match the gain on the CGY correctly. Use the [▲ /+] or [▼ /-] key to setting the gain.

Setting ranges: 0 ~ 150% Initial value: 100%

Go to the menu title of RUD. Basic screen 1/2

Gov. BASIC MENU (GOVERNOR BASIC SETTING)

This menu sets the governor's fundamental functions. The menu Servo limit point setting must be set first.

"GOV. BASIC" screen from the "BASIC MENU" screen.

From 6/6 From the "SBUS2 rpm Slot" of GOV. BASIC screen 6/6

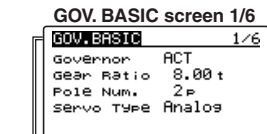

Note: When using the governor function, be sure to make each setting of "GOV.BASIC".

Note: After completing the linkage of the throttle, be sure to set the "Servo limit point setting" first, and then set the other functions.



Go to 2/6 from any cursor position

Governor ACT

(1) Governor: Governor active

Set the governor operation mode of CGY. The initial setting is "ACT (active)" where, as the designation implies, the governor is active. If you do not want to use governor, select "INH (Inhibit)".

Setting: ACT (Active) / INH (Inhibit) Initial setting: ACT

Gear Ratio 8.00 t

(2) Gear Ratio:

Input the main rotor gear ratio by pushing the [▲/+] or [▼/-] key to select the desired working mode.

Setting ranges: 1.00 ~ 50.00 t Initial value: 8.00 t

Notes:

- If the gear ratio is not properly set, the set speed and actual engine speed will be different.
- The gear ratio should be given in the helicopter instruction manual. If the helicopter instruction manual does not give the gear ratio, calculate the gear ratio as follows:

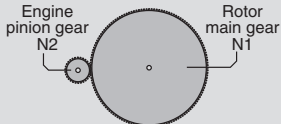

Gear ratio = $N1/N2$
Carry values less than 1/1000 to the next whole number.

Pole Num. 2P

(3) Pole Num.: Pole number

This parameter is used when using a direct phase sensor attachment to a brushless motor lead. Input the motor pole count as specified by the brushless motor manufacturer. When using any revolution sensor other than a direct phase sensor type, set the pole number to 2p.

Note: For nitro use, set to 2p.

Note: The input signal range of the CGY is 0.0v - 3.0v. Exceeding this voltage range may cause damage to the CGY.

Setting ranges: 2~24P Initial value: 2P

Servo Type Analog

(4) Servo Type

Select the throttle servo type. Digital servos offer the best response. Move the cursor to "Servo Type" by pressing the [▲/+] or [▼/-] key and press the [Enter] key to enter the setting mode. Select the servo type with the [▲/+] or [▼/-] key. Pressing the [Enter] key exits the setting mode.

Setting: Analog/DG:1520 Initial setting: Analog

⚠ WARNING

❗ The servo type parameter within the CGY must match the type of servo you are using. Incorrect settings may damage the CGY or the servo. An incorrect setting may also result in the loss of control during flight.

From 1/6

GOV. BASIC screen 2/6

GOV. BASIC 2/6
RPM Set 3 GvOff
Stick SW ON 230%
ON/OFF SW INH
BAT F/S INH

⚠ CAUTION

⊘ There is a danger of heavy loads being applied to the rotor rotating at high speed. Dropout of the rotor blade, damage of the head, etc., may occur. Do not set the rotation speed to a value that exceeds the strength limit of the helicopter and rotor.

Go to 3/6 from any cursor position

RPM Set 1 1000 rpm RPM Set 2 1500 rpm RPM Set 3 2000 rpm

(5) RPM set.: RPM setting

Setting the main rotor RPM. This is calculated by engine revolution with the gear ratio of the main shaft.

When the rotation speed can be set with the governor mixing function of the transmitter, it is necessary to first match the display rpm value of 1-2-3 of "RPM Set" with the display rpm value of the transmitter.

Setting ranges: off /700 ~ 4,000 rpm **Initial value:** 1,000 rpm

*To set lower than 1,000 rpm, set "Low. Revo" (page 91) of "GOV. EXPERT" menu to 700 rpm.

Stick SW OFF 0%

(6) Stick sw.: Stick switch

The governor can be activated by throttle stick position. Move the cursor to "Stick sw" by pressing the [▲/+] or [▼/-] key and press the [Enter] key to enter the setting mode. "EXECUTE: Enter (1 sec)" is displayed. Move the throttle stick to the desired governor on position. Press the [Enter] key for about 1 second, memorizing that point. This stick switch function is always enabled when the next "ON/OFF sw" is "INH" or the "Governor ON/OFF switch is not set by S.BUS setting.

When governor is turned on and off by transmitter throttle stick

The data is set so that the governor can be turned on and off with the transmitter throttle stick position. The following describes this operation.

- Throttle stick over set point and more than 60% of set rotation speed. →→→ ON

*This is the setting value of "(9) Gov. On. Revo: Governor ON revolution setting" on page 90.

- Throttle stick held at the set point or more Remains. →→→ ON
- Throttle stick position is below the set point selected. →→→ OFF

(Governor operating point)

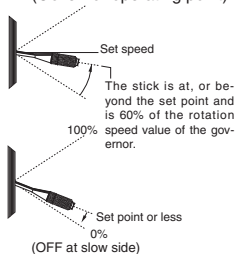

When idle up

- When the throttle curve is set at idle up, and when the throttle output is over the set value (initial value: 30%), the governor will always and remain ON even if the stick is lowered to the bottom.



(7) ON/OFF sw.: Governor on/off switch

This parameter allows the user to turn the governor on or off via a switch on the transmitter. Pressing the [▲/+] or [▼/-] key activates the function. Choose INH if you do not want to use it.

When turning on/off governor with switch

Select the ON / OFF switch channel with "GOV sw channel" on "SBUS BASIC" menu.

Setting the switch to the ON position turns on, or enables the governor. The following describes this operation.

- Switch set to on position and engine running at 60% or more of set speed → → → ON
- Throttle stick set to maximum slow position → → → ON
- Switch set to off position → → → OFF



Governor can be turned on and off by a switch.

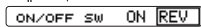

When you activate the switch, the direction setting of the switch is displayed. Select the switch ON / OFF direction (NORM/REV) with the [▲/+] or [▼/-] key.

(8) BAT F/S: Battery fail safe

When the receiver battery voltage becomes equal to or less than "BFS. Volt" set in the "GOV EXPERT" menu, the battery fail safe function is activated, the governor function is turned OFF, and the throttle servo moves to the set position.



When the setting is completed, the "!" Mark is displayed.

When Battery Fail Safe is enabled, items for setting the throttle servo position are displayed. The setting method is the same as "Stick sw", so please refer to this section of the manual for information on setting this function.

If the battery voltage is lower than the set voltage of the "Battery F/S" for about 3 seconds, the Gx (gyro) LED of the CGY solid red light. When "Battery F/S" is set to "ACT" in "GOV BASIC", the servo is fixed to the throttle position set by "Battery F/S". When the throttle stick is set to the slowest position, the "Battery F/S" function is temporarily canceled. However, after 30 seconds, the "Battery F/S" function is activated again and the servo is locked. When the "Battery F/S" operates, quickly landing and stopping the helicopter, please charge the battery.

From 2/6 ↑ ↓
➔ GOV. BASIC screen 3/6

GOV. BASIC	3/6
Lim.set Id	SET
Lim.set Hi	SET
Limit Test Idle	HIGH

↑ ↓ ➔ Go to 4/6 from any cursor position

Lim.set Id	SET
------------	-----

How to set the servo limit point:

Set the transmitter's throttle stick to the idle position. Select [Lim. Set Id] with the [▲/+] or [▼/-] key and press the [Enter] key to enter the setting mode. "EXECUTE: Enter (1 sec)" is displayed. Press the [Enter] key for about 1 second. The cursor will move to "Lim. Set HI". Set the stick to the full high position and set the same as "Lim. Set Id". If the setting data is not normal (servo operation amount is 50% or less), "Err" is displayed. In this case, check the transmitter setting and repeat this procedure once again.

Limit Test	Idle	HIGH
------------	------	------

(10) Limit Test: Check the set limit point

Check the set limit point. Use the [▲/+] or [▼/-] key to move the cursor to "LIMIT Test Idle" and press the [Enter] key to move the servo to the idle point "END" will be displayed on screen. Similarly on the high side, use the [▲/+] or [▼/-] key to select the cursor "LIMIT Test HIGH" and test it with the [Enter] key.

From 3/6 ↑ ↓
➔ GOV. BASIC screen 4/6

GOV. BASIC	Cond1	4/6
senseTyp	Nitro	
GOV.Gain	C1	40%
L Lmt.L rpm	C1	25%
L Lmt.H rpm	C1	45%

↑ ↓ ➔ Go to 5/6 from any cursor position

⚠ WARNING

❗ When using the CGY for the first time, or when making changes in the throw of a servo and its linkage, always perform the limit setting operation.

(9) Lim. set: Servo limit point setting

Servo limit point setting defines the overall travel range for the throttle servo. It is fundamental for governor operation and must be set prior to other functions. Servo limits must also be reset when the throttle linkage or trim are changed. Refer to the next page for setting procedures and adjustments.

↑ ↓
SenseTyp Nitro

(11) SenseTyp: Sensor type

Select the type of governor sensor.

Nitro (BPS-1 backplate; Magnet Type)

1:1 Magnet "1:1 Mag" (Magnet type applied to helicopter part that turns at the same RPM as the main rotor)

HPoleEP: For Electric motors 8 poles and above

LPoleEP: For electric motors 6 poles.

↑ ↓
GOV.Gain 40% Cond

(12) GOV Gain: Governor gain

Governor Gain. If the value of the Governor Gain is set too low, the helicopter's RPM will fluctuate with collective and cyclic pitch changes. Conversely, if the number is too high, the RPM itself will fluctuate and surge during flight.

Setting ranges: 1 - 100%

Initial value: Nitro = 40%, 1:1Magn = 60%, HPoleEP = 30%, LPoleEP = 10%

↑ ↓
L Lmt.L rpm 25% Cond

↑ ↓
L Lmt.H rpm 45% Cond

(13) L Lmt. L rpm / H rpm: Low limit RPM

Low RPM Limit sets the minimum amount of throttle that the governor will command during an over-speed situation. Too low of value the engine could shut off or not recover power quickly enough during the next collective movement. If the value is set too high, the governor will not control overspeed when the rotor head is unloaded.

Use:

L Lmt. L rpm: For RPMS of 700-1700

L Lmt. H rpm For RPMS of 1701-4000

Setting ranges: L Lmt. L rpm = 0 - 80%, L Lmt. H rpm = 10 - 80%

Initial value: L Lmt. L rpm = 25%, L Lmt. H rpm = 45%

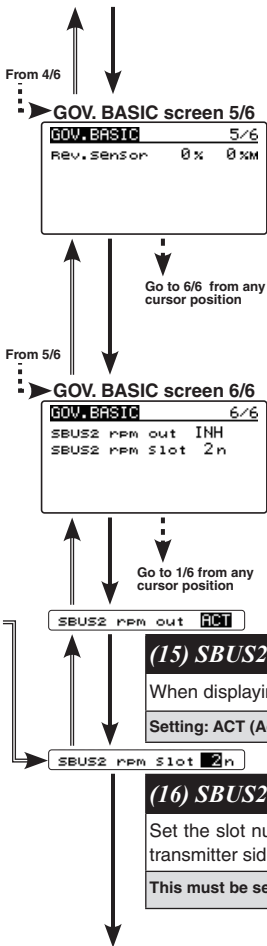

(14) Rev. Sensor: Revolution sensor testing

This menu is utilized to ensure that the revolution sensor is functioning properly. The display for this testing is found in: GOV BASIC 5/6.

In order to test the sensor, do NOT start the engine. Instead, we recommend turning the engine over by hand or the utilization of a starter. To prevent inadvertent ignition of the engine, do NOT use a glow plug igniter when turning the engine over.

The numerical values on the left side of the display are the current value. The right side of the display indicates the maximum sensor value. The output level needs to be more than 60% for correct governor operation. Also, when using the backplate sensor, the signal level of the backplate sensor varies depending on the rotation speed (3,000 rpm or more is the detectable rotation speed).

By the telemetry function, the number of revolutions read by the governor sensor can be displayed on the monitor of the transmitter. In order to be able to display, activate the telemetry rotation sensor (SBS-01RM) on the transmitter and set the gear ratio to 1.00.

Note: It can not be used when the transmitter is FASSTest 12CH system.

(15) SBUS2 rpm out: RPM display on transmitter

When displaying the rpm with the telemetry function, set it to ACT.

Setting: ACT (Active) / INH (Inhibit) Initial setting: INH

(16) SBUS2 rpm Slot: RPM display on transmitter

Set the slot number of the telemetry rotation sensor registered on the transmitter side.

This must be set so that no slots overlap one another.

Go to the menu title of GOV. BASIC screen 1/6

****Governor Speed Setting***

If the governor switch is ON when the power is turned ON, the governor will not turn ON.

Once you turn off the ON state, the governor is ready for operation. Always turn off the governor when starting the engine.

The CGY's rpm selection is accomplished by setting the channel in section (8) "RPM channel" menu located within the "S.BUS Basic Setting" to the governor speed setting channel of your system. When using an independent governor on/off switch, activate the section (7) "Governor on/off switch" function within the "Governor Basic Setting" section earlier in this manual (page 64).

Direct set by transmitter on Gov. mixing

- When governor mixing is used to switch the RPM of the rotor head speed, the head speed can be switched with each condition of the switch.

*For a description of the governor mixing, please refer to your transmitter's manual.

Using by 3 position switch

- Set the RPM at each switch position in the "(5) RPM setting" menu within the "Governor Basic Setting" section earlier in this manual.

****Governor operation***

The CGY operates from 700 to 4000 rpm main rotor speed. However, the engine must be running at the set speed. The CGY turns off the governor when the engine is starting or idling.

Condition of the governor to be on

For safety purposes, the governor is turned on when the conditions below are satisfied.

- The on/off switch conditions are set to off during power on.
- The stick switch is in the on position when it is used.
- The on/off switch is in the on position when it is used.
- Setting speed is not off.
- The engine speed exceeds to 60% of the setting speed.
- The speed sensor is working properly.

WARNING

ⓘ Safety reminder: Remember to configure your transmitter fail safe settings for not only the throttle channel but also the governor ON/OFF channel to ensure that the governor correctly disengages should the radio enter a fail safe condition.



RECOMMENDED GYRO GAIN SETTINGS

Recommended gain settings:

The optimum sensitivity is the position just before the gyro starts hunting. To achieve this optimum setting, it is necessary to adjust the gyro gain settings after actually flying the helicopter.

Size	Recommended Gyro Gain	
	Rotor Head Gyro	RUD Gyro
450-550	45 to 55%	45 to 55%
600-700	50 to 60%	50 to 60%
750-more	55 to 65%	55 to 65%

*50% is a good starting point for rudder gain regardless of model size.



ADJUSTMENTS DURING THE TEST FLIGHT

Pre-flight checklist

- Check that the transceiver's battery is fully charged.
- Check whether the gyro tape is torn or peeled.
- Turn on the transmitter / receiver and initialize the gyroscope.
- Check whether the servo type setting matches the servo being used (Rudder / Swash).
- Check that the servo horn is neutral and perpendicular to the push rod. (Rudder / Swash).
- Confirm that the maximum servo movements are not physically bound throughout the range of motion. (Rudder and swash).
- Check that the gyro is operating in the correct mode (AVCS or normal) (Rudder).
- Check whether the operation of each input matches the operation of the tail rotor / swash plate.
- When rotating the aircraft body, make sure that corrective action is performed in the correct direction.
- Is the gyro sensitivity set correctly for all flight conditions? Also, check whether it is operating in the correct mode (AVCS or normal).

⚠ WARNING

! Always level the swash plate using the cyclic stick before applying throttle and spooling up the main rotor blades. During takeoff small corrections may be necessary. If you make large corrections while the helicopter is on the ground, it may tip over since the helicopter is firmly on the ground and the gyros are over-compensating due to the lack of movement.

! Some helicopters may have a tendency to resonate/shake during spool up. Always leave the helicopter on the ground until this resonance or shaking goes away. If this issue continues, it is recommended to try some rubber skid stops or take off from a softer surface such as grass. Vibrations contribute to this ground resonance. Verify that everything on your model is balanced correctly.

*When the CGY is used with an ESC or BEC and a power switch is not used, there is a possibility of an intermittent connection when connecting the flight battery. This may cause the CGY initialization to fail. Always ensure that the gyro has initialized properly by verifying that the gyros are compensating as the helicopter is moved. It is recommended to use a power switch on the power supply line to avoid this possibility.

Rudder Gyro Trim Flight:

The tail rotor/rudder AFR or D/R function within the transmitter is used to adjust the pirouette rate of the helicopter to suit your requirements. Do NOT use ATV or rudder channel travel adjustment for this purpose. For optimum performance, the tail rotor should be trimmed in Normal/Rate mode as closely as possible with adjustments to the tail rotor pushrod length before finalizing with transmitter trim and then memorizing that value into the CGY.

The tail rotor gyro gain should be raised until the tail begins to oscillate quickly (also called tail "wag"). Once this point has been achieved, reduce the gain as needed a few percent at a time to eliminate the oscillation. Repeat the process for all flight conditions. The main rotor speed, tail rotor ratio, tail rotor pitch range and tail blade length play a large part in achieving optimum tail rotor performance. The gain value can vary drastically from model to model, and the exact value should not play a part in the evaluation of the gyro's performance.



WARNING

! **Safety Reminder:** Remove both main and tail blades from the model and/or disengage the motor's pinion from the main gear before proceeding with any electric governor set up.

- Make sure your ESC is configured for external governor use. Refer to the owner's manual for your ESC.
- You may use either a brushless phase sensor or the traditional governor magnetic sensor with a magnet mounted in a collar on the main shaft or in the main gear. With one magnet, set the gear ratio to 1:1.
- When choosing a brushless phase sensor, observe the input signal range of the CGY specified in the Governor Basic section.
- Refer to the manufacturer's documentation for your electric motor to select the correct pole count when using a brushless phase sensor. Pole count is set to 2 when using a magnetic sensor.
- Set the governor Working Mode (Wrk.Mode) in "GOV EXPERT" menu.
- Set the servo type (ServoTyp) to DG:1520.
- Make sure you correctly calibrate your ESC.
- Make sure you calibrate the governor speed ranges in the transmitter's governor menu and set the high and low limits for throttle in the Governor Basic menu.
- If a tail "kick" or "jerk" is observed when switching from one idle-up head speed to another, INCREASE the Revolution Up and Down delays (Revo.Up Dlyo/Revo.Dn Dly – "GOV. EXPERT" Menu). Increase 2-5% at a time until the tail "kick" is suppressed.
- The greater the electronic speed control headroom built into the model as a function of its gearing, the more prone the tail will be to kicking with aggressive flying. Models geared for high head speed but flown aggressively at low head speed present the greatest challenge for the governor. The more optimally your model is geared for your chosen head speed, the better the governor will function.
- Excessive governor gain worsens tail kick. Use as little gain as necessary for adequate head speed control.
- If the model yaws nose left with aggressive collective input, activate and adjust the PIT→RUD F/F (feed forward) mixing. Increase in 2-5% increments. F/F mixing should ADD pitch to rudder with added positive or negative collective pitch assuming a CW main rotor direction.



TRANSMITTER ROTOR HEAD GYRO GAIN SET-UP

Transmitter Set-up for adjusting cyclic gains via the transmitter.

Using the Remote Gain Functions (roll, pitch and yaw)

1. Some Futaba transmitters contain auxiliary gain functions for aileron, elevator and yaw. Please refer to your transmitter's instruction manual. Assign the Gyro (RUD), Gyro (Rotor Head replaces AIL/ELE) channels within the transmitter. Within the CGY "S.BUS BASIC" menu → Rotor Head Gyro Gain – In the SBUS menu assigning "Rotor Head gain" to a channel will allow the Rotor head gain to be adjusted via the transmitter. If you are using a 5 or 6CH transmitter, setting "Rotor Head gain" to "INH" will then default the gain to "BaseGain" in the "FLT. TUNE" menu. Suggested setting and default is CH9. Tail Rotor Gain "Gain RUD" – In the SBUS menu assigning "Gain RUD" to a free transmitter channel will allow for the tail rotor gain to be adjusted via the transmitter. Suggested setting and default is CH5.
2. The gyro function within your transmitter should list all three gain channels. Adjustments can be made from within this function. The gyro function can usually be assigned to various switches or conditions to offer greater adjustability. Please refer to your transmitter's instruction manual for further details.

WARNING

! Verify that the gyro compensates in the correct direction for all three axes before flight. If the compensation direction is incorrect, the model will roll, flip, or pirouette uncontrollably even before it leaves the ground.

Setting the CGY gains by using endpoints or manual adjustments

1. If your transmitter does not support the remote gain adjustment it is still possible to use a spare channel on the transmitter to make the adjustments. Assign unused channels (verify that these channels are not assigned or operated by a switch or dial) within the transmitter. Set the "Rotor Head gain" channels in the "S.BUS.Basic" menu to the appropriate channel. Use the end point adjustment within your transmitter for these channels to make the gain adjustments and the reverse function within the transmitter to set the mode "AVCS/NOR". Conditions with the transmitter may also be used to achieve different gains based upon flight modes. Please refer to your transmitter's instruction manual for further details.

Manual gain adjustment

1. If your setup does not leave any channels free, or if your transmitter does not support auxiliary gain adjustment, then it is possible to adjust the gain manually within the CGY. Set both the "Rotor Head gain" in the "SBUS. BASIC" menu to "INH". The gain adjustments are now made by entering the "BaseGain" in the "FLT. TUNE" menu and pressing the [▲/+] or [▼/-] key.

This menu enables the user to further refine the gyro and governor settings.

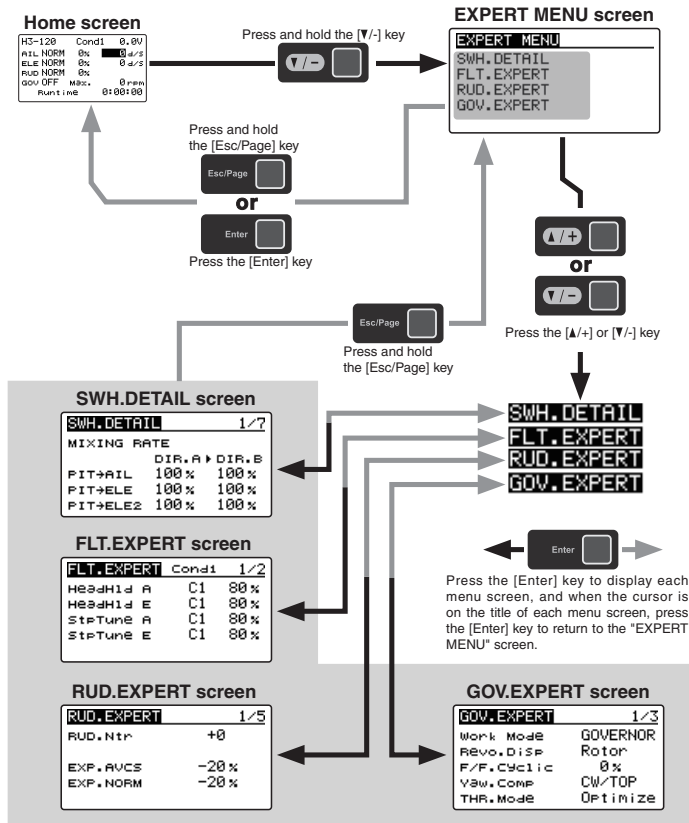

RUD. EXPERT MENU (RUDDER GYRO EXPERT SETTING)



The rudder Expert menu allows for further refinement of the tail rotor gyro performance. "RUD. EXPERT" screen from the "EXPERT MENU 3D" screen.

From 5/5  From the "Sens. Model" of RUD. EXPERT screen 5/5

RUD. EXPERT screen 1/5

RUD. EXPERT	1/5
RUD. Ntr	+0
EXP. AVCS	-20%
EXP. NORM	-20%



  Go to 2/5 from any cursor position

RUD. Ntr  +0

(1) RUD Ntr: Rudder servo neutral setting

This parameter is used to set the neutral position of the rudder servo. Position the rudder servo arm as perpendicular as possible to the tail rotor pushrod prior to making adjustments with this parameter. Move the cursor to "RUD Ntr" with the [Δ /+] or [∇ /-] key and press the [Enter] key to enter the setting mode. Adjust the neutral position with the [Δ /+] or [∇ /-] key. When you finish adjusting, press [Enter] key to exit setting mode.

Setting ranges: -240 ~ 0 ~ +240 Initial value: +0

EXP. AVCS  -20%

EXP. NORM  -20%

(2) EXP. AVCS / EXP. NORM: Rudder exponential

This parameter sets the feel of the tail rotor control around center. When set to [0] the control curve is linear. Using a [+] value the tail rotor will be more sensitive around neutral conversely, using a [-] value will soften the feeling around neutral. The RUD EXP parameter in your transmitter can also be used to tune the tail rotor to a desired feeling.

Setting ranges: -100 ~ 0 ~ +100% Initial value: AVCS = -20%, NORM = -20%

Sports = AVCS -60% / NORMAL -40%, 3D = AVCS -20% / NORMAL -20%>

From 1/5  
▶ RUD. EXPERT screen 2/5

RUD. EXPERT	2/5
CNT. D1In	▶ 15n
CNT. D1In	15n
CNT. D1Out	▶ 12n
CNT. D1Out	12n

 ▶ Go to 3/5 from any cursor position

CNT. D1In ▶ 15n

(3) CNT. D1In: Control delay in

This parameter sets the delay as you move the stick from neutral toward left or right. Larger values result in a softer tail rotor feel off center. This parameter must be adjusted individually for LEFT and RIGHT tail rotor commands. Hold the cursor to "CNT. D1In" by pressing the [▲/+] or [▼/-] key. Move the rudder stick to the left or right by amount the "▶" cursor moves. Enter the setting mode by pressing the [Enter] key, adjust the amount of delay with the [▲/+] or [▼/-] key, and then press the [Enter] key to exit the setting mode. Follow these same procedures to adjust the tail rotor feel in the opposite direction.

Setting ranges: 0 ~ 20n Initial value: 15n

CNT. D1Out ▶ 12n

(4) CNT. D1Out: Control delay out

This parameter sets the delay when the stick is returned back to the neutral position. This parameter is useful to tune how aggressively the tail rotor stops following a pirouette. The higher the value, the softer the stop. This parameter must be adjusted individually for LEFT and RIGHT tail rotor commands. The setting method is the same as "CNT. D1In", so please refer to the information above.

Setting ranges: 0 ~ 20n Initial value: 12n

From 2/5 ↑ ↓
⋮
➤ RUD. EXPERT screen 3/5

RUD. EXPERT		3/5
ANG	720	d

Go to 4/5 from any cursor position

ANG	720	d
-----	-----	---

(5) ANG: Pirouette speed

This parameter adjusts the maximum pirouette speed of the tail rotor that the gyro will allow at 100% dual rate. Use the [▲/+] or [▼/-] key to adjust the maximum commanded pirouette rate.

Setting ranges: 100 ~ 999 d Initial value: = 720 d,

From 3/5 ↑ ↓
⋮
➤ RUD. EXPERT screen 4/5

RUD. EXPERT		4/5
F/F.Rate U		+0%
F/F.Rate D		+0%
ACC.Gain		0%

Go to 5/5 from any cursor position

F/F.Rate U	+0%
------------	-----

F/F.Rate D	+0%
------------	-----

(6) F/F.Rate U / F/F.Rate D: F/F mixing rate

Feed Forward mix is used to counteract sudden increases in torque from the motor during fast collective pitch changes. If you notice a tail kick, using (right rudder on Clockwise rotor disk, left rudder on CCW) F/F mixing can be tuned to reduce the tail kick. The mixing amount can be individually set for high pitch side (U) and low pitch (D) side with zero pitch as the center.

Setting ranges: -100 ~ 0 ~ +100% Initial value: +0%

↑ ↓
ACC. Gain 0 %

(6) ACC Gain: F/F mixing acceleration gain

In low head speed situations where a lot of F/F Mixing might be needed, acc. gain boosts the input and removes it immediately after to help cure the sudden change in torque, but it does not allow the large tail rotor input to alter the axial behavior of the helicopter.

Setting ranges: 0 ~200% Initial value: 0%

From 4/5

⋮
➤ RUD. EXPERT screen 5/5

RUD. EXPERT 5/5
Tail RESP. 1
RESET RUD. Gyro

↑ ↓ ⋮ ➤ Go to 1/5 from any cursor position
Tail RESP. 1

(7) Tail Resp: Tail response

The goal is to match the response between the helicopter tail response and the gyro control. This feature is utilized to do so. 1 is the fastest response. Generally, if the tail response is slow or the servo's speed is slow, setting the tail response setting late will increase the gyro sensitivity and improve the control performance. Also, if the response setting is delayed, the power consumption of the servo will be reduced. However, if the response setting is too late, the operation cannot keep up with high-speed operation of the helicopter.

Setting ranges: 1 ~5 Initial value: 1

➤ RESET RUD. Gyro

(8) RESET : Rudder gyro data reset

This resets the "RUD.EXPERT" setting back to the defaults. Move the cursor to "RESET" by pressing the [▲/+] or [▼/-] key, and press the [Enter] key to enter the reset mode. When "EXECUTE: Enter (1 sec)" is displayed, press and hold the [Enter] key for about 1 second to initialize "RUD.EXPERT" setting. If you do not wish to reset, press [Enter] key or [Esc/Page] key to exit the reset mode.

Go to the menu title of RUD. EXPERT screen 1/5

FLY. EXPERT MENU (CYCLIC GYRO EXPERT SETTING)

The "FLY.EXPERT" menus allow further refinement of cyclic gyro performance. "FLY. EXPERT" screen from the "EXPERT MENU 3D" screen.

From 2/2
From the "RESET" of FLY. EXPERT screen 2/2

FLY. EXPERT screen 1/2

FLY. EXPERT	Cond	1/2
HeadHld A	C1	80%
HeadHld E	C1	80%
StpTune A	C1	80%
StpTune E	C1	80%

*The current condition number of CGY is displayed.
*The setting with "C#" display can be set for each condition.

1. Use the [▲/+] or [▼/-] key to move the cursor to "C#" and press the [Enter] key to enter the condition selection mode. Use the [▲/+] or [▼/-] key to select the condition number "C#" and press the [Enter] key to decide the condition number.
2. Next, adjust value of the condition selected by the [▲/+] or [▼/-] key, and press the [Enter] key to enter the setting mode. Use the [▲/+] and [▼/-] keys to change the setting value. When you are done, press the [Enter] key to exit the setting mode.

Go to 2/2 from any cursor position

HeadHld A [C1] 80% Cond ▲/+ : → ▼/- : →
HeadHld E [C1] 80% Cond EscPage : →

(1) HeadHld A / HeadHld E: Head hold aileron / elevator

This features is used to adjust the heading hold aspect of the gyro control. If the helicopter is not holding angle or cyclic control rates, increasing the heading hold gain will improve holding the helicopter at a certain angle and improve the cyclic rate consistency. If this is set too high you could see an oscillation on that axis. Lowering the heading hold below default would be used if the transmitter gain is reduced and a consistent oscillation is still not fixed during flight.

Setting ranges: 0 ~200% Initial value: 80%

StpTune A [C1] 80% Cond

(2) StpTune A : Stop tune aileron

Cyclic stop tuning on the aileron axis. If the helicopter continues to coast after an after an ail roll, lowering "StpTune A" will create a harder stop action to remove the coasting. If the helicopter bounces on the aileron axis after an aileron control input, increasing "StpTune A" will reduce this bounce.

Setting ranges: 0 ~250% Initial value: 80%

↑ ↓
StopTune E C1 80% Cond

(3) StopTune E: Stop tune elevator

Cyclic stop tuning on the elevator axis. If the helicopter, after an elevator flip, continues to coast, lowering "StopTune E" will create a harder stop action to remove the coasting. If the helicopter continues to coast after an elevator flip, lowering the "Stop tune E" will reduce this bounce.

Setting ranges: 0 - 250% Initial value: 80%

FLT. EXPERT screen 2/2

↑ ↓

FLT. EXPERT	Cond1	2/2
HeadResp	C1	1
DeadBand		4.0
RESET		FLT. Tun

↑ ↓

Go to 1/2 from any cursor position

HeadResp C1 Cond

(4) HeadResp: Head Response

Head Response matches the gyro control speed to that which the helicopter is capable of reacting. In a standard helicopter a Head Response of 1 should always be used, but on some scale applications, or uniquely designed rotor heads, increasing head response might be needed to cure over correction of the gyro.

Setting ranges: 1 - 10 Initial value: 1

↑ ↓

DeadBand 4.0

(5) DeadBand: Dead band

Transmitter control dead band. If you are noticing inconsistent swash plate drift or poor initialization it could be poor transmitter potentiometer resolution. If you have to increase this value beyond 10.0, it is best to check calibration on your transmitter.

Setting ranges: 0 - 25 Initial value: 4.0



(6) RESET : FLT tune data reset

This resets the "FLT.Tun" setting back to the defaults. Move the cursor to "RESET" by pressing the [▲/+] or [▼/-] key, and press the [Enter] key to enter the reset mode. With "EXECUTE: Enter (1 sec)" displayed, press and hold the [Enter] key for about 1 second to initialize "FLT.Tun" setting. If you do not wish to reset, press [Enter] key or [Esc/Page] key to exit the reset mode.

Go to the menu title of FLT. EXPERT screen 1/2

SWH. DETAIL MENU (SWASH DETAIL SETTING)

The swash detail setting is used to keep the swash plate level at high and low collective pitch to cyclic interactions and cyclic pitch to collective pitch interactions. "SWH. DETAIL" screen from the "EXPERT MENU 3D" screen.

From 2/2...
From the "RESET" of FLT. DETAIL screen 7/7

SWH. DETAIL screen 1/7

MIXING RATE	DIR. A	DIR. B
PIT→AIL	100%	100%
PIT→ELE	100%	100%
PIT→ELE2	100%	100%

▲/+ : →
▼/- : →
Exc/Page : ... →

Go to 2/7 from any cursor position

PIT→AIL 100% 100%

(1) PIT→AIL: collective pitch → aileron mixing rate

Going from MID to HIGH and MID to LOW collective pitch check that the swash plate is traveling flat throughout the entire range. Using the [▲ /+] or [▼ /-] key to level the swash plate on the aileron axis to the middle point by raising or lowering the aileron servo.

Setting ranges: 30 ~ 150% Initial value: 100%

PIT→ELE 100% 100%

(2) PIT→ELE: collective pitch → elevator mixing rate

Going from MID to HIGH and MID to LOW collective pitch check that the swash plate is traveling flat throughout the entire range. Using the [▲ /+] or [▼ /-] key to level the swash plate on the elevator axis to the middle swash position by raising or lowering the elevator servo.

Setting ranges: 30 ~ 150% Initial value: 100%

PIT→ELE2 100% 100%

(3) PIT→ELE2: collective pitch → 2nd elevator mixing rate

This parameter adjusts the pitch to 2nd elevator mixing rate. The rates can both be adjusted individually for both full high and low collective positions. **Note:** This setting is only available if the **H4-xx swash mode** has been selected.

Setting ranges: 30 ~ 150% Initial value: 100%

From 1/7

SWH. DETAIL screen 2/7

SWH. DETAIL 2/7		
MIXING RATE		
	DIR. A	DIR. B
AIL→PIT	100%	100%
AIL→ELE	100%	100%
AIL→ELE2	100%	100%

(4) AIL→PIT: aileron → collective pitch mixing rate

At the middle collective pitch, check that during right to left and left to right aileron action the swash plate is staying level on both the elevator and collective pitch axis. If the swash plate is rising or falling with aileron inputs, use the [▲/+] or [▼/-] key to raise or lower the swash plate to match the middle point during aileron inputs.

Setting ranges: 30 ~ 150% Initial value: 100%

AIL→PIT 100% 100%

Go to 3/7 from any cursor position

AIL→ELE 100% 100%

(5) AIL→ELE: aileron → elevator mixing rate

This parameter adjusts the aileron to elevator mixing rate. The rate can be adjusted for left and right directions individually. **Note:** This setting is only available if the **H4-45 swash mode** has been selected.

Setting ranges: 30 ~ 150% Initial value: 100%

AIL→ELE2 100% 100%

(6) AIL→ELE2: aileron → 2nd elevator mixing rate

This parameter adjusts the aileron to 2nd elevator mixing rate. The rate can be adjusted for left and right directions individually. **Note:** This setting is only available if the **H4-45 swash mode** has been selected.

Setting ranges: 30 ~ 150% Initial value: 100%

From 2/7
SWH. DETAIL screen 3/7

SWH.DETAIL		3/7
MIXING RATE		
	DIR.A	DIR.B
ELE→PIT	100%	100%
ELE→AIL	100%	100%
ELE→ELE2	100%	100%

ELE→PIT 100% 100%

Go to 4/7 from any cursor position

(7) ELE→PIT: elevator→collective pitch mixing rate

During back and forward elevator inputs at middle collective, check if the swash plate is raising or lowering during the input. If it is moving use the [▲/+] or [▼/-] key to raise or lower the swash plate to match the middle point during elevator inputs. **Note:** This setting can not be used when **H4-00 swash mode** is selected.

Setting ranges: 30 ~ 150% Initial value: H3-120 = 50%, except H3-120 = 100%

ELE→AIL 100% 100%

(8) ELE→AIL: elevator→aileron mixing rate

While moving the elevator back and forth at middle collective, check to make sure the aileron axis is staying level. Use the [▲/+] or [▼/-] key to raise or lower to level the swash plate so that it remains level during full forward and back elevator input. **Note:** This setting can not be used when **H4-00 swash mode** is selected.

Setting ranges: 30 ~ 150% Initial value: H3-120 = 50%, except H3-120 = 100%

ELE→ELE2 100% 100%

(9) ELE→ELE2: elevator →2nd elevator mixing rate

This parameter adjusts the elevator to 2nd elevator mixing rate. The rate can be adjusted separately for up and down directions individually. **Note:** This setting is only available if the **H4-xx swash mode** has been selected.

Setting ranges: 30 ~ 150% Initial value: 100%

From 3/7

SWH. DETAIL screen 4/7

SWH.DETAIL			4/7
COMPENSATION			
	DIR.A	DIR.B	
AIL High	0%	0%	
AIL Low	0%	0%	
AIL Dir	+		

Go to 5/7 from any cursor position

AIL High 0% 0%

AIL Low 0% 0%

(10) AIL High / AIL Low: Linkage compensation aileron

At HIGH pitch and LOW pitch check to make sure that the swash plate is staying level on the elevator and collective axis when using aileron inputs. If the swash plate is rising or falling, use the [▲/+] or [▼/-] key to maintain the swash plate position the same as that noted in the centered aileron inputs. **Note:** check all four directions: high/right; high/left; low/right; low/left

Setting ranges: 0~100% Initial value: 0%

AIL Dir +

(11) AIL Dir: Compensation direction of the aileron

If the above Data (+/-) correction from 0-100 is NOT in the correct compensation direction, change the value from [+] or [-] using the [▲/+] or [▼/-] key.

Setting: +/- Initial setting: +

From 4/7 ↑ ↓
▶ SWH. DETAIL screen 5/7

SWH. DETAIL			5/?
COMPENSATION			
	DIR.A	DIR.B	
ELE High	0%	0%	
ELE Low ▶	0%	0%	
ELE Dir	+		

↑ ↓ ⋮ ▶ Go to 6/7 from any cursor position

ELE High 0% 0%

ELE Low ▶ 0% 0%

(12) ELE High / ELE Low: Linkage compensation elevator

At both the HIGH pitch and LOW pitch check to make sure that the swash plate is staying level on the aileron and collective axis when using elevator inputs. If the swash plate is rising or falling, use the [▲/+] or [▼/-] key to maintain the swash plate position the same as it is in the middle during elevator inputs. **Note:** check all four directions: high/back; high/forward; low/back; low/forward.

Setting ranges: 0 ~ 100% Initial value: 0%

ELE Dir +

(13) ELE Dir: Compensation direction of the elevator

If the above Data (+/-) correction from 0-100 is NOT in the correct compensation direction, change the value from [+] or [-] using the [▲/+] or [▼/-] key.

Setting: +/- Initial setting: +

From 5/7
SWH. DETAIL screen 6/7

SWH. DETAIL	6/7
SPEED Comp	0%
SWASH Rot	+0 DEG.

SPEED Comp	0%
------------	----

(14) Speed Comp: Speed compensation

In 120 degrees CCPM all servos do not travel the same distance on elevator input. Having previously set the ELE-PIT and ELE-AIL parameters, if during rapid movement of the elevator axis the swash plate is not staying level, use the [▲/+] or [▼/-] key to match all servo speeds.
Note: a (+ will slow the Aileron/Pitch Servo – will reduce speed comp on Aileron/Pitch Servo).

Setting ranges: 0 ~ 100% Initial value: H3-120 = 50%, except H3-120 = 0%

SWASH Rot	+0 DEG.
-----------	---------

(15) SWASH Rot: Swash rotation

Using the [▲/+] or [▼/-] key, electronically add rotor head phasing to the swash plate controls. If possible, it is recommended to use mechanical phasing adjustment, but if the rotor head does not allow this and you feel that the model is NOT flying axially on each control input, this parameter can be used to adjust the pure reaction of each axis in flight. (Typically advanced phasing on clockwise rotor disk and a slight clockwise increase in swash plate alignment vs rotor axle are needed to create an axial reaction. The opposite is true for a counterclockwise rotor disk model.)

Setting ranges: -90 deg ~ +90 deg Initial value: +0 deg

From 6/7
↑ ↓
SWH. DETAIL screen 7/7

SWH.DETAIL	7/7
RESET	SWASHset

↑ ↓
Go to 1/7 from any cursor position

RESET	SWASHset
-------	----------

(16) RESET : Swash detail data reset

This resets the "SWH.DETAIL" setting back to the defaults. Move the cursor to "RESET" by pressing the [▲/+] or [▼/-] key. Press the [Enter] key to enter the reset mode. When "EXECUTE: Enter (1 sec)" is displayed, press and hold the [Enter] key for about 1 second to initialize "SWH.DETAIL" setting. If you do not wish to reset, press either the [Enter] key or [Esc/Page] key to exit reset mode.

Go to the menu title of SWH. DETAIL screen 1/7

GOV. EXPERT MENU (GOVERNOR EXPERT SETTING)

This menu sets the Governor Expert parameters, allowing the user to further refine the governor settings.

"GOV EXPERT" screen from the "EXPERT MENU 3D" screen.

From 3/3 From the "RESET" of GOV. EXPERT screen 3/3

GOV. EXPERT screen 1/3

GOV. EXPERT	1/3
Work Mode	GOVERNOR
Revo. Disp	Rotor
F/F. Cyclic	0%
Yaw. Comp	CW/TOP
THR. Mode	Optimize

Go to 2/3 from any cursor position

Work Mode **GOVERNOR**

(1) Work Mode: Governor working mode

Sets the governing type mode.

- **GOVERNOR** (Governor Mode) – RPM is entirely controlled by the GOV once it has engaged. The GOV will do whatever it takes to hold a constant RPM throughout flight.
- **Rev. Lmt** (Limiter Mode) – Throttle control follows the throttle curves to advance the throttle position during flight, but controls the RPM during throttle reduction by not letting the RPM overspeed past the set RPM. When the Rev.Lmt mode is selected, the menu (5) "THR. Mode" should be set to Tx.Curve mode.

Setting: GOVERNOR/Rev. Lmt Initial setting: GOVERNOR

Revo. Disp **Rotor**

(2) Revo Disp: Governor working mode

This enables the user to display either the desired rotor RPM or the Engine RPM accordingly.

Setting: Rotor/Engine Initial setting: Rotor

F/F. Cyclic **0%**

(3) F/F. Cyclic: Feed Forward from Cyclic

Increasing the value will add throttle with cyclic commands to aid in RPM stability.

Setting ranges: 0~100% Initial value: 0%

↑ ↓
Yaw. Comp CW/TOP

(4) Yaw. Comp: Governor working mode

Yaw compensation allows the governor to more rapidly correct for changes in power demands of the model resulting from yaw input. Set the mode to match the gyro installation direction. Select from: CW/TOP, CW/BOTM, CCW/TOP, CCW/BOTM by pressing the [▲/+] or [▼/-] key. **Note:** if the user has selected the governor only mode, this parameter is inhibited.

Revolution fluctuation in the case of pirouettes

The governor detects the rpm via the revolution sensor mounted in the engine section. During a pirouettes, the helicopter itself rotates, so that its pirouettes speed is added (reduced) to the engine speed. Therefore, the main rotor speed will fluctuate accordingly. Since the CGY has a gyro, it can accurately measure the pirouette speed. The yaw rate correction is thus determined by a combination of gyro function and governor function.

CW: clockwise rotor direction

CCW: counter clockwise rotor direction

TOP: Gyro top/name emblem facing up

BOTM: Gyro top/name emblem facing down

Setting: CW/TOP, CW/BOTM, CCW/TOP, CCW/BOTM Initial setting: CW/TOP

↑ ↓
THR. Mode Optimize

(5) THR. Mode: Throttle data mode

This parameter selects the throttle input operation. Pressing the [▲/+] or [▼/-] key will change the mode.

Optimize:

CGY sets the throttle input signal to optimum. There is no need to consider the throttle curve setting on the transmitter.

Fixed:

This is the suggested mode for use with electric motors. This setting ensures that there is a fixed throttle input as is related to the helicopter revolution.

Tx.Curve:

If this mode is selected, the CGY uses the exact throttle input from the transmitter. As such, the throttle curve setting on the transmitter is required. **Note:** when the Rev.Lmt mode is selected, this mode should also be selected.

Setting: GOVERNOR/Rev. Lmt Initial setting: GOVERNOR

From 1/3

GOV. EXPERT screen 2/3

GOV. EXPERT	2/3
Revo. Up Dly	8 Frm
Revo. Dn Dly	10 Frm
Start Dly	5 Frm
Gov. On. Revo	60 %
BFS. Volt	3.8 v

(6) Revo. Up Dly: Revolution change up delay

How quickly the RPM changes when increasing RPM between two different RPM conditions and flight modes. A higher number slows the RPM change rate; a lower value speeds up the RPM change rate.

Setting ranges: 2 ~40 Frm Initial value: 8 Frm

Go to 3/3 from any cursor position

Revo. UP Dly	8 Frm
--------------	-------

Revo. Dn Dly	10 Frm
--------------	--------

(7) Revo. Dn Dly: Revolution change down delay

How quickly the RPM changes when reducing RPM between two different RPM conditions and flight modes. A higher number slows the RPM change rate; a lower value speeds up the RPM change rate.

Setting ranges: 2 ~40 Frm Initial value: 10 Frm

Start Dly	5 Frm
-----------	-------

(8) Start Dly: Start delay

How quickly the RPM stabilizes to the set RPM from when the GOV is turned ON. A higher value slows down the spool up rate; a lower value speeds up the spool up rate.

Setting ranges: 2 ~20 Frm Initial value: 5 Frm

Gov. On. Revo	60 %
---------------	------

(9) Gov. On. Revo: Governor ON revolution setting

This parameter tells the governor at what percentage of the set rpm it is to become active. The default value is 60%. In this case, the governor will not engage until the engine rpm reaches 60% of the set rpm. If you feel that the time for governor engagement is too slow, decrease the value to 50 ~55%. The starting time will be faster.

Setting ranges: 50 ~90% Initial value: 60%

BFS.Volt 3.8v

(10) BFS.Volt: Battery F/S voltage setting

This parameter sets the battery fail safe and low battery alarm voltage levels, or thresholds. Set the proper voltage as determined by the battery type. The battery characteristics are different depending on cell type/chemistry. The voltage setting is changed by pushing the [▲/+] or [▼/-] key. Suggested setting voltages are as follows.

- 4 cells NiCd or NiMH (Normal: 4.8 v) = 3.8 v
- 2 cells LiFe (Normal: 6.6 v) = 6.0 ~ 6.2 v
- 2 cells LiPo (Normal: 7.4 v) = 7.2 ~ 7.4 v

From 2/3

GOV. EXPERT screen 3/3

GOV. EXPERT 3/3
Low.Revo 1000rpm
RESET Governor

Low.Revo 1000rpm

Go to 1/3 from any cursor position

(11) Low.Revo: Low revolution setting

This value is set to assign the lowest possible governing RPM. If the RPM is below, or can not reach this RPM, the governor will not engage. Select between either 1,000 rpm or 700 rpm. It corresponds also to a helicopter with a rotor speed of 1,000 rpm or less, such as a large gas machine.

Setting: 700/1,000 rpm Initial setting: 1000 rpm

RESET Governor

(12) RESET : Governor expert data reset

This resets the "GOV. EXPERT" setting back to the defaults. Move the cursor to "RESET" by pressing the [▲/+] or [▼/-] key. Press the [Enter] key to enter the reset mode. When "EXECUTE: Enter (1 sec)" is displayed, press and hold the [Enter] key for about 1 second to initialize "GOV. EXPERT" setting. If you do not wish to reset, press [Enter] key or [Esc/Page] key to exit the reset mode.

Go to the menu title of GOV. EXPERT screen 1/3

WRITE Screen

Writes data saved in GPB-1 to CGY.

You can copy data when replacing the CGY in your machine.

- The data to be written is the "BASIC" menu and "EXPERT" menu.
- With the exception, the setting of ACT / INH of "Internal" on the "RECEIVER" screen of the GPB-1 menu is written (for CGY760R).

WARNING

After writing, if the setting is "INH", the internal receiver is operating without turning off the power supply once. If the receiver is connected while it is operating, the helicopter crashes with inoperable state.

- When copying from another CGY, connect the copy source CGY to the GPB-1 in advance and let the GPB-1 read the setting data.

CAUTION

If you press [Ent] start from the opening screen and display the home screen, the setting data of the connected CGY will be saved in GPB-1. Please save the setting data to be written again to GPB-1.

Opening screen

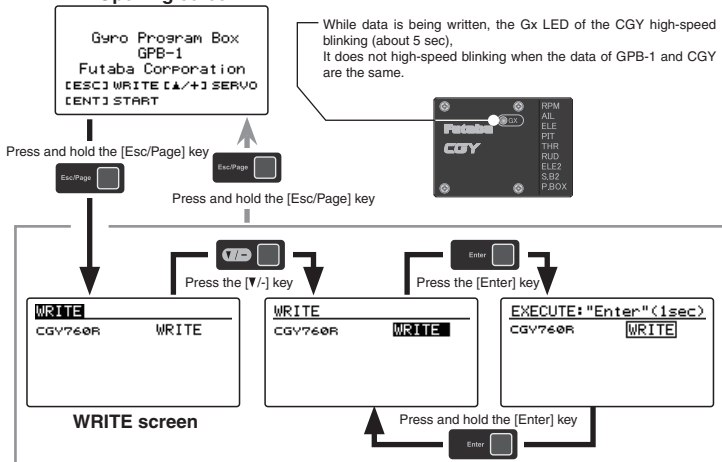

S.BUS SERVO SETTING Screen

An S.BUS servo can memorize the channel and various settings you input. Servo setting can be performed on the GPB-1 screen by wiring the servo as shown in the figure.

*With some S.BUS(2) servos, there are some functions which cannot be used. If a function cannot be used, the display screen will change.

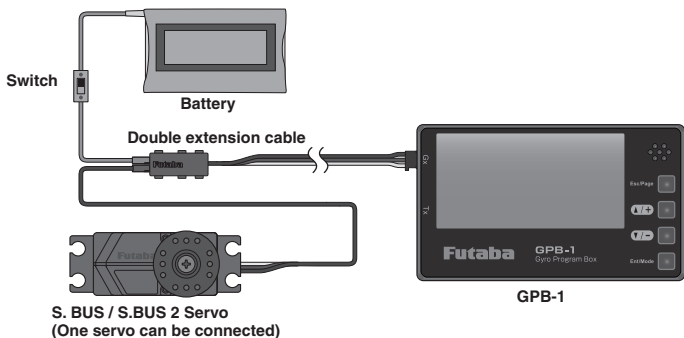

CAUTION

 Be sure to connect each servo and set it.

If multiple servos are connected at the same time, the servo may be damaged.

 Be sure to turn off the power when replacing the servo.

Servo may be damaged if servo is replaced while power is on.

 Please match the voltage of the battery to be used with the specifications of the servo to be connected.

Servo will be damaged if voltage higher than specified is applied.

WARNING

 Never connect CGY and GPB-1 when setting S.BUS servo. The helicopter becomes uncontrollable and crashes.

* Even if the servo is operating on the bench, it could be damaged.

```

SBUS SERVO 1/4
RECALL WRITE INIT.
CH 1 id 051-00033
-Servo Type-
HPS-H700 SELECT
DG:1520 ▶ SWH:760
  
```



Press the [Enter] key

```

EXECUTE: "Enter" (1sec)
RECALL WRITE INIT.
CH 1 id 051-00000
-Servo Type-
HPS-H700
DG:1520 ▶ SWH:760
  
```



Press and hold the [Enter] key

```

EXECUTE: "Enter" (1sec)
RECALL WRITE INIT.
CH 1 id 051-00033
-Servo Type-
HPS-H700 SELECT
DG:1520 ▶ SWH:760
  
```

```

SBUS SERVO 1/4
RECALL WRITE INIT.
CH 1 id 051-00033
-Servo Type-
HPS-H700 SELECT
DG:1520 ▶ SWH:760
  
```



Press the [Enter] key

```

EXECUTE: "Enter" (1sec)
RECALL WRITE INIT.
CH 1 id 051-00033
-Servo Type-
HPS-H700 SELECT
DG:1520 ▶ SWH:760
  
```



Press and hold the [Enter] key

```

EXECUTE: "Enter" (1sec)
RECALL WRITE INIT.
CH 1 id 051-00033
-Servo Type-
HPS-H700 SELECT
DG:1520 ▶ SWH:760
  
```

(2) WRITE

Write the data set with GPB - 1 to the connected S.BUS servo. Move the cursor to "WRITE" by pressing the [▲/+] or [▼/-] key. Press the [Enter] key to enter the writing mode. When "EXECUTE: Enter (1 sec)" is displayed, press and hold the [Enter] key for about 1 second. To cancel, select press [Enter] key or [Esc/Page] key to exit the recall mode.

- "COMPLETED!" is displayed on the screen and the setting data is written to servo.

- If "FAILED" is displayed on the screen, repeat [WRITE] or turn the power off and confirm the connection, then turn the power on and perform the operation again.

```

COMPLETED!
RECALL WRITE INIT.
CH 1 id 051-00033
-Servo Type-
HPS-H700 SELECT
DG:1520 ▶ SWH:760
  
```

```

FAILED !
RECALL WRITE INIT.
CH 1 id 051-00033
-Servo Type-
HPS-H700 SELECT
DG:1520 ▶ SWH:760
  
```

(3) INIT.

Write the factory set servo setting data to the connected servo. Move the cursor to "INIT" by pressing the [▲/+] or [▼/-] key. Press the [Enter] key to enter the writing mode. When "EXECUTE: Enter (1 sec)" is displayed, press and hold the [Enter] key for about 1 second. To cancel, select press [Enter] key or [Esc/Page] key to exit the recall mode. The setting of the channel setting and servo type (760 us / 1520 us) is not initialized.

- "COMPLETED!" is displayed on the screen and the initial-
izing a setting data is written to servo.

- If "FAILED" is displayed on the screen, repeat [INIT] or turn the power off and confirm the connection, then turn the power on and perform the operation again.

```

COMPLETED!
RECALL WRITE INIT.
CH 1 id 051-00033
-Servo Type-
HPS-H700 SELECT
DG:1520 ▶ SWH:760
  
```

```

FAILED !
RECALL WRITE INIT.
CH 1 id 051-00033
-Servo Type-
HPS-H700 SELECT
DG:1520 ▶ SWH:760
  
```

Change servo type

Changing the servo pulse width from 1520 to 760 is possible with the servo type function.

Display of "servo type" when reading

* When "RECALL" is executed, the servo type name is displayed on the left side of the screen, and the current 760 or 1520 type is displayed below it. The S.BUS servo not supporting servo type change displays "Unsupported".



The S.BUS servo which can change the servo type of 760 μ S and 1520 μ S is indicated as "SELECT" on the right side and DG: 760 or SWH 760 below it. The servo whose servo type can not be changed is indicated as "Unsupported" in the servo type name.

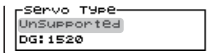

* Current type



Press the [Enter] key

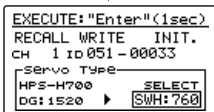

Press and hold the [Enter] key



Change servo type DG:1520 \leftrightarrow DG:760

Change the servo type (760 μ S / 1520 μ S) to the connected servo. Move the cursor to the type under "SELECT" by pressing the [▲/+] or [▼/-] key. Press the [Enter] key to enter the changing mode. When "EXECUTE: Enter (1 sec)" is displayed, use the [▲/+] or [▼/-] keys to select the servo type to change, press and hold the [Enter] key for about 1 second. To cancel, select press [Enter] key or [Esc/Page] key to exit the changing mode.

- "COMPLETED!" is displayed on the screen and The type display on the left side is updated to the changed type. Initialize each parameter.

- If "FAILED" is displayed on the screen, please go again or turn the power off and confirm the connection, then turn the power on and perform the operation again.



Updated servo type



* A new S.BUS servo (example: HPS-H700) that can set both parameters for swash (SWH: 760) and Rudder (RUD: 760) is loaded first, the servo type name on the left side, DG: 1520, SWH: 760 is displayed under "SELECT" on the right side. Changing the servo type from SWH: 760 to RUD: 760 will display RUD: 760 under the servo type name the next time you load it. However, if you change the parameter of RUD: 760, the subsequent reading will show SWH: 760. Please mark so that the set servo type can be determined.

Notes on servo set to 760 μ S

To connect the servo set to "DG: 760" or "SWH: 760" to AIL/ELE/PIT/ELE2, set the servo type to "DG: 760".

To use the servo set to "DG: 760" or "RUD: 760" for RUD, set the servo type to "DG: 760".

Please set the servo type to "DG: 285 Hz" for the AIL/ELE/PIT/ELE2 servo set to "DG: 1520". For RUD servo, set the servo type to "DG: 1520".

⚠ CAUTION

❗ Be sure to connect the servo and CGY with the same setting. If you connect a different setting servo with CGY, the servo may be damaged.

Servo type: 760 μ S



Servo type: 1520 μ S



When the CH setting is DG 1 or DG 2

If the CH setting is DG 1 or DG 2, the servo type can not be changed. Before changing to Servo type, you need to set it to CH 1 to 16 with CH setting and execute "WRITE".



⚠ CAUTION

⊘ The servo of 760 μ S is not connected to ordinary CH, SBUS/SBUS 2 connector such as receiver not compatible.

The servo may be damaged.

⊘ Do not set 760 μ S servo parameters with transmitter unsupported to 760 μ S and PC S-LINK software. Be sure to set parameters with GPB-1.

The servo may be damaged.

Description of function of each parameter

With some S.BUS(2) servos, there are some functions which cannot be used.

If a function cannot be used, the display screen will change.

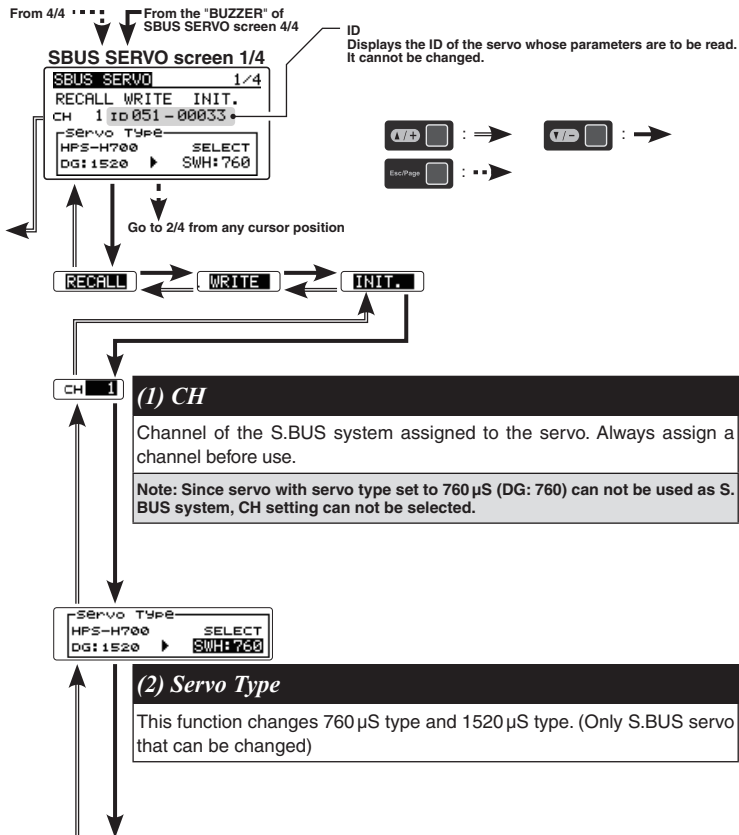

From 1/4
SBUS SERVO screen 2/4

SBUS SERVO	2/4
TRAVEL	LEFT 100.0% RIGHT 100.0%
NEUTRAL	+ 0.00 DEG.
DEADBAND	0.11 DEG.
SPEED	INH

Go to 3/4 from any cursor position

TRAVEL	LEFT 100.0% RIGHT 100.0%
--------	--------------------------

NEUTRAL	+ 0.00 DEG.
---------	-------------

(4) NEUTRAL

The neutral position can be changed. When the neutral offset is large value, the servo's range of travel is restricted on one side.

If the servo CH setting is 1 to 16 CH, you can set it while checking the position of neutral, but in the case of DG 1 and DG 2, you can not check the position of neutral.

DEADBAND	0.30 DEG.
----------	-----------

(5) DEADBAND

The dead band angle at stopping can be specified.

[Relationship between dead band set value and servo operation]

Small Value Setting → Dead band angle is small and the servo is immediately operated by a small signal change.

Large Value Setting → Dead band angle is large and the servo does not operate at small signal changes.

Note: If the dead band angle is too small, the servo will operate continuously and the current consumption will increase and the life of the servo will be shortened.

SPEED	INH
-------	-----

(6) SPEED

Speeds can be matched by specifying the operating speed. The speed of multiple servos can be matched without being affected by motor fluctuations. This is effective for load torques below the maximum torque.

However, note that the maximum speed will not exceed what the servo is capable of even if the servo's operating voltage is increased.

(3) TRAVEL (LEFT/RIGHT)

The left and right travels centered about the neutral position can be set independently.

From 2/4
SBUS SERVO screen 3/4

SBUS SERVO	3/4		
REVERS	NORM	TYPE	NORM
SMOOTHER	ON		
SOFTSTAT	3.00s	/60DEG.	
BOOST	5%		OFF
DAMPER	56		

Go to 4/4 from any cursor position

REVERS NORM

(7) REVERS

The direction in which the servo rotates can be changed.

Setting: NORM / REV

TYPE NORM

(8) TYPE

When "Retractable" is selected and the servo has been continuously stopped for 30 seconds, the dead band expands and unnecessary hold current due to external force is eliminated. When a new control signal enters, normal operation is resumed. When using the servo as a landing gear servo, select "Retractable". Also adjust the servo travel to match the landing gear movement range. When the servo type is OLP mode, the torque and time for OLP can be set on SBUS SERVO screen 4/4. When the load is greater than this setting torque and continues over this setting time, OLP works.

Setting: NORM / OLP / RETR

SMOOTHER ON

(9) SMOOTHER

This function changes smoothness of the servo operation relative to operation signal changes. Normally use at Smooth setting. Especially, select the "OFF" mode when quick operation is necessary.

Setting: ON/OFF Initial setting: ON

SOFTSTAT 3.00s/60DEG

(10) SOFTSTART

Restricts operation in the specified direction the instant the power is turned on. By making this setting, only the first operation when the power is turned on slowly moves the servo to the specified position.



(11) BOOST - ON/OFF

The minimum current applied to the internal motor when starting the servo can be set. Since a small travel does not start the motor, it essentially feels like the dead band was expanded. The motor can be immediately started by adjusting the minimum current which can start the motor.

OFF : It is the boost ON at the time of low-speed operation. (In the case of usual)

ON : It is always the boost ON. (When quick operation is hope)

[Relationship between boost set value and servo operation]

Small Value Setting → Motor reacts to a minute current and operation becomes smooth.

Large Value Setting → Initial response improves and output torque increases. However, if the torque is too large, operation will become rough.

(12) DAMPER

The characteristic when the servo is stopped can be set.

When smaller than the standard value, the characteristic becomes an overshoot characteristic. If the value is larger than the standard value, the brake is applied before the stop position.

Especially, when a large load is applied, overshoot, etc. are suppressed by inertia and hunting may occur, depending on the conditions. If hunting (phenomena which cause the servo to oscillate) occurs even though the Dead Band, Stretcher, Boost and other parameters are suitable, adjust this parameter to a value larger than the initial value.

[Relationship between damper set value and servo operation]

Small Value Setting → When you want to overshoot. Set so that hunting does not occur.

Large Value Setting → When you want to operate so that braking is not applied. However, it will feel like the servo response has worsened.

Note: If used in the hunting state, not only will the current consumption increase, but the life of the servo will also be shortened.

From 3/4
SBUS SERVO screen 4/4

SBUS SERVO	4/4
STRETCH	x2.000
BUZZER	OFF

Go to 1/4 from any cursor position

STRETCH x2.000

(13) STRACTCH (Stretcher)

The servo hold characteristic can be set. The torque which attempts to return the servo to the target position when the current servo position has deviated from the target position can be adjusted. This is used when stopping hunting, etc., but the holding characteristic changes as shown below.

[Relationship between stretcher and servo operation]

Small Value Setting → Servo holding force becomes weaker.

Large Value Setting → Servo holding force becomes stronger.

Note: When this parameter is large, the current consumption increases.

BUZZER OFF

(14) BUZZER

When a servo is powered up without a transmitter signal, a buzzer sounds.

When transmitter signal is lost, a buzzer sounds until the servo regains the signal. This is not unusual.

The transmitter has been turned OFF ahead of a servo power supply → The buzzer sound of about 1.25 Hz continues sounding as servo power supply end failure alarm.

Do not insert or remove the servo connector while the receiver power is ON.

A buzzer may sound by incorrect recognition.

Note: Buzzer sound is generated by vibrating the motor of a servo. Since current is consumed and a servo generates heat, please do not operate the number more than needed or do not continue sounding a buzzer for a long time.

SBUS servo screen 3/4
(8) When TYPE setting is "OLP"

SBUS servo screen 3/4
(8) When TYPE setting is "NORM" or "RETR"
Go to the menu title of SBUS SERVO screen 1/4

The following can be displayed and set only when the type setting is "OLP".

↑ ↓
Trq 100%

(15) Trq

This is the torque for working OLP.

Setting: 10% - 100% Initial setting: 100%

100% is the maximum torque of the servo which you are setting.

← →
TIME 5s

(16) TIME

This is the time for working OLP. Set the time when OLP (Over Protection) functions. Displayed only when the type is OLP setting.

Setting: 0.2, 0.5, 1, 2, 3 sec, 4, 5, 6, 7, 8, 9, 10, 15, 20, 25, 30 sec

Initial setting: 5 sec

Note: If the setting of OLP torque and time is decreased, it is easier to work OLP. Then, please be careful not to work OLP at usual operation.

Go to the menu title of SBUS SERVO screen 1/4

The changeable S. BUS servo of 760 μ S and 1520 μ S
HPS-H700/HPS-HC700

(As of February 2020)

VIA TRAINER FUNCTION

When using "Via Trainer" which wirelessly transfers gyro setting data from the transmitter, connect the transmitter and the GPB-1 as shown below.

Futaba transmitters other than T32MZ have only one connection.

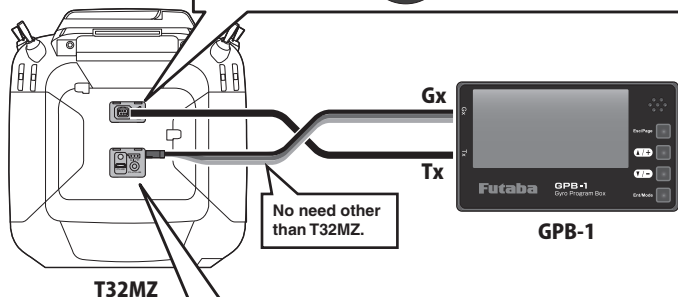
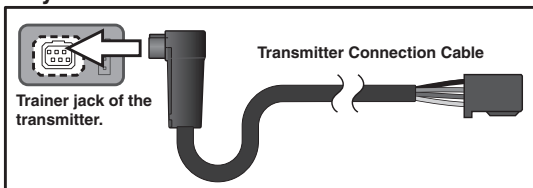

T32MZ need two connections.

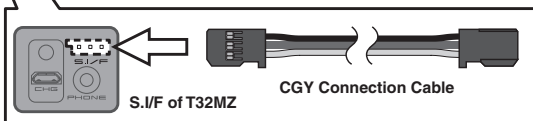

⚠ CAUTION

- ❗ Be sure to check the operation for all conditions 1 to 5 before flying.
- ❗ Be sure to connect and disconnect the transmitter and GPB-1 connection cable with the power off.

3D VIA TRAINER SCREEN FUNCTION LIST

Via Trainer 1/10	
<AIL/ELE>	
B950 Gain	C1 100 x
CYC.Rt	C1 300 d/s
Cnt.AuthAIL	C1 40%
Cnt.AuthELE	C1 40%

-FLT. TUNE

Base Gain: Gyro base gain setting (page 53)
CYC. Rt: Cyclic rate setting (page 53)
Cnt. AuthAIL: Control Authority Aileron (page 54)
Cnt. AuthELE: Control Authority Elevator (page 54)

Via Trainer 2/10	
<AIL/ELE>	
EXPO.	C1 -20%
FLT.Styl	C1 +50n

EXPO.: Exponential (page 55)
FLT. Styl: Flight style (page 55)

Via Trainer 3/10	
<AIL/ELE>	
ELE.Comp	C1 0%

ELE. Comp: Elevator pre compensation (page 56)

Via Trainer 4/10	
<SWASH>	
SWS.Rate	C1 50%
PIT.Rate	C1 50%
SWS.Ring	C1 130%

-SWH. BASIC

SWS. Rate: Rate adjustment (page 49)
PIT. Rate: Rate adjustment (page 50)
SWS. Ring (page 50)

Via Trainer 5/10	
<GOVERNOR>	
GOV.Gain	C1 40%
L Lmt.L RPM	C1 25%
L Lmt.H RPM	C1 45%

-GOV. BASIC

GOV Gain: Governor gain (page 66)
L Lmt. L rpm : Low limit hovering RPM (page 66)
L Lmt. H rpm : Low limit idling RPM (page 66)

Via Trainer 6/10	
<FLT>	
HeadHld A	C1 80%
StpTune A	C1 80%
HeadRESP	C1 1

-FLT. EXPERT

HeadHld A : Head hold aileron (page 78)
StpTune A : Stop tune aileron (page 78)
HeadResp: Head Response (page 79)

Via Trainer 7/10	
<FLT>	
HeadHld E	C1 80%
StpTune E	C1 80%

HeadHld E: Head hold elevator (page 78)
StpTune E : Stop tune elevator (page 79)

Via Trainer 8/10	
<RUD>	
EXP.AVCS	-20%
EXP.NORM	-20%

-RUD. EXPERT

EXP. AVCS: Rudder exponential AVCS (page 74)
EXP. NORM: Rudder exponential NORMAL (page 74)

Via Trainer 9/10	
<RUD>	
CNT.DlIn	15n
CNT.DlIn	15n
CNT.DlOut	12n
CNT.DlOut	12n

CNT. DlIn: Control delay in (page 75)
CNT. DlOut: Control delay out (page 75)

Via Trainer 10/10	
<RUD>	
ANG	720 d
Tail Resp.	1

ANG: Pirouette speed (page 76)
Tail Resp: Tail response (page 77)

GPB-1 Software Update

The GPB-1 can be updated from PC using CIU-2 or CIU-3.

* The following optional products are required for the update.

- CIU-2 or CIU-3
- Cable for CGY760R/CGY755/GY701/GY520 or DSC cable for update
- Receiver battery

1. Download the CGY760R/CGY755 update file from our website or your local distributor's website.

2. Extract the zip file on your computer.

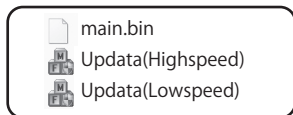

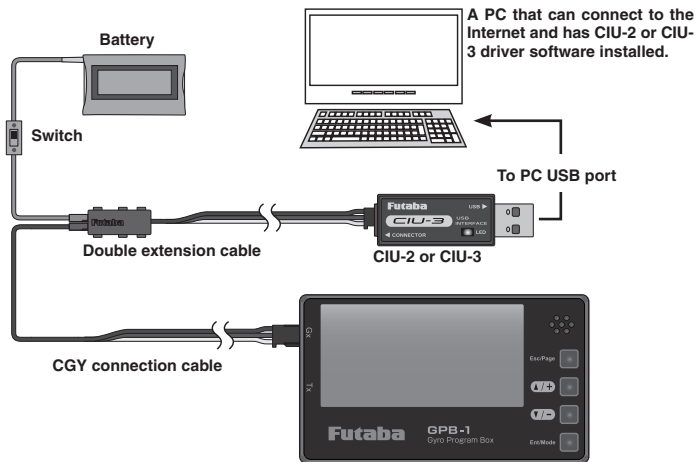

3. Connect as shown in the figure.



PC side

4. Start an executable file by a PC.

CIU-3  Update(Highspeed)

CIU-2  Update(Lowspeed)

Double-click

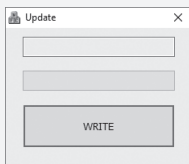

GPB-1 side

5. When using the CIU-3, hold down the [Enter] and [Esc/Page] keys of the GPB-1 and turn on the power. Release the [Enter] and the [Esc / Page] keys when the backlight of the screen lights up.

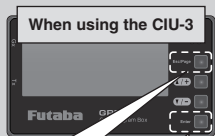

Press the [Enter] and [Esc/Page] keys next turn ON



When using the CIU-2, hold down the [▲/+] and [▼/-] keys of the GPB-1 and turn on the power. Release the [▲/+] and [▼/-] keys when the backlight of the screen lights up.

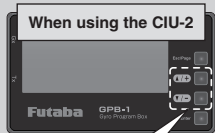

Press the [▲/+] and [▼/-] keys next turn ON



PC side

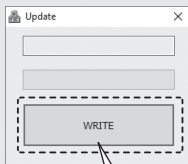

Click [WRITE]

WRITE

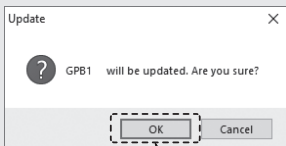

Click [OK]

OK

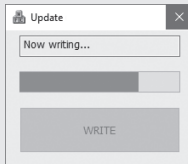

GPB-1 side

When using the CIU-3

PROGRAM UPDATE (HI)
READY

When using the CIU-2

PROGRAM UPDATE
READY

CAUTION

 Do not turn off the power or remove the battery while updating. GPB-1 may be damaged.



PROGRAM UPDATE (HI)
NOW WRITING



Wait for about 50 seconds - 5 minutes.

Don't turn on the power !

PC side

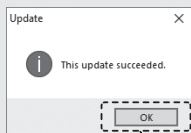

Click [OK]

GPB-1 side

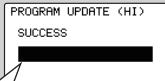

Wait for about 50 seconds - 5 minutes.

6. Turn off the power after the completed message "SUCCESS" appears.
7. Check the GPB-1 program version on the Information screen.
8. Be sure to check each setting and check the operation before using.

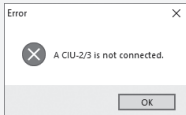

Error

If an error display appeared, the redo an update from the beginning.

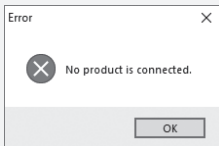
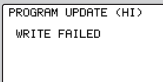

If the cable disconnects or a contact failure occurs during the update, the update stops halfway. In that case, please try updating again from the beginning.

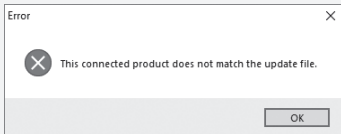

If the GPB-1 fails to update or does not start, please have it serviced.



MOUNTING OF CGY WITH SCREWS

⚠ WARNING

❗ If using screws to mount the CGY to the helicopter, it is imperative to ensure that the machine does not vibrate excessively.

*Please do not mount with machine screws with vibration, please mounting with a dedicated mounting pad.

Drill holes in the plate

Refer to the figure below. Drill holes in the mounting plate accordingly.

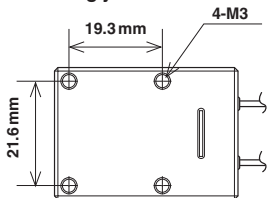

CGY755 has no antenna

Screw size for attachment

The effective length of the screw hole of the CGY main unit is 7 mm.

Use the M3 screw whose length is less than the plate thickness plus 7 mm.

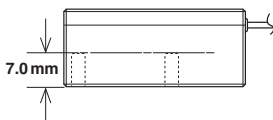

Mounting

Attach the CGY to the mounting plate using M3 screws from the bottom of the plate as shown in the example.

Ensure that the screws are no longer than the plate thickness plus 7 mm.

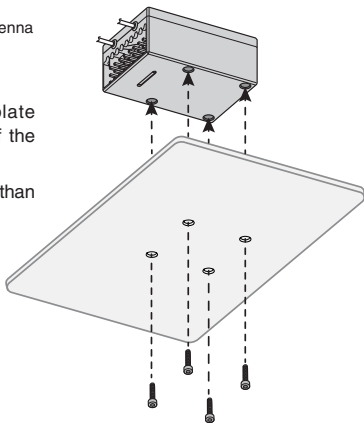

Notes:

*Ensure that these mounting screws will not come loose during flight.

*As the CGY case is aluminum, please be careful not to over-tighten the mounting screws.

CGY760R

- Control System:** Digital advanced control
Angular Velocity Range: $\pm 1,000$ Degrees Per Second (Gyro)
Sensor: Micro Electromechanical Systems (MEMS) Gyro
Hall effect sensor
Governor Resolution: 0.1 Hz (6rpm) (Engine RPM)
RPM Accuracy: 1%
Head Speed Range: 700-4,000 rpm
Selectable Servo Frame: 70 Hz, 280 Hz and 560 Hz (Rudder Gyro only) Rate
Center Pulse Width: 1520 μ S (70 Hz & 280 Hz) 760 μ S (560 Hz)
Receiving system: FASSTest-2.4 GHz (18 CH/12 CH mode) / T-FHSS-2.4 GHz
S.BUS2/S.BUS Port and 6 Channels for Conventional System
Frequency band: 2.4 GHz band
RF power output: 25 mW EIRP
Antenna: Dual antenna diversity
Rated voltage: 3.7 V to 7.4 V DC* (Operating Voltage: 3.5 V to 8.4 V)
Current Drain: 85 mA (When receiving, no servo, no RPM sensor)
Operating Temperature: 14°F to 113°F (-10°C to +45°C)
Size (CGY760R): 1.055 in. [26.8 mm](W) / 1.476 in. [37.5 mm](L) / 0.63 in. [16 mm](H)
Weight (CGY760R): 0.713 oz [20.2 g]

CGY755

- Control System:** Digital advanced control
Angular Velocity Range: $\pm 1,000$ Degrees Per Second (Gyro)
Sensor: Micro Electromechanical Systems (MEMS) Gyro
Hall effect sensor
Governor Resolution: 0.1 Hz (6rpm) (Engine RPM)
RPM Accuracy: 1%
Head Speed Range: 700-4,000 rpm
Selectable Servo Frame: 70 Hz, 280 Hz and 560 Hz (Rudder Gyro only) Rate
Center Pulse Width: 1520 μ S (70 Hz & 280 Hz) 760 μ S (560 Hz)
Rated voltage: 3.7 V to 7.4 V DC* (Operating Voltage: 3.5 V to 8.4 V)
Current Drain: 85 mA (When receiving, no servo, no RPM sensor)
Operating Temperature: 14°F to 113°F (-10°C to +45°C)
Size (CGY755): 1.055 in. [26.8 mm](W) / 1.476 in. [37.5 mm](L) / 0.63 in. [16 mm](H)
Size (Revolution sensor): 0.827 in. [21 mm](W) / 0.63 in. [16 mm](L) / 0.39 in. [10 mm](H)
Weight (CGY755): 0.705 oz [20.0 g]

RPM sensor

- Size:** 0.827 in. [21 mm](W) / 0.63 in. [16 mm](L) / 0.39 in. [10 mm](H)
Weight: 0.141 oz [4 g]

GPB-1

Rated voltage: 3.7V to 7.4V DC* (Operating Voltage:3.5V to 8.4V)

Current Drain: 62mA

Operating Temperature: 14°F to 113°F (-10°C to +45°C)

Display: 128 x 64 dot graphics

Size: 2.126 in. [54mm](W)/3.543 in. [90mm](L)/0.6102 in. [15.5mm](H)

Weight(RPM sensor): 1.88 oz [53.3g]

* The operating voltage shown only applies to the CGY760R/CGY755 and GPB-1. Always verify that your receiver, servos, tail rotor servo, switch and any other electronic components used in your installation are capable of operating at the voltage you plan to use.

FUTABA CORPORATION

oak kandakajicho 8F 3-4 Kandakajicho, Chiyoda-ku, Tokyo 101-0045, Japan

TEL: +81-3-4316-4820, FAX: +81-3-4316-4823

©FUTABA CORPORATION 2020, 02 (1)



Flybarless Control Gyro

CGY760R

CGY755

Gyro Program Box

GPB-1